



2020

PRIMUL VEAC DE ÎNVĂȚĂMÂNT
UNIVERSITAR ÎN TIMIȘOARA

Research Report 2019

**Annual
Research
Report**

Politehnica
University
Timisoara

2019

Research Report 2019

Research Report, 2019

Copyright © Editura Politehnica 2020

All rights reserved to Politehnica University Timisoara.

No part of this booklet may be reproduced or transmitted in any form or by any means, electronic or mechanical, including photocopy, recording, or any information storage and retrieval system now known or to be invented, without permission in writing from the publisher, except by a reviewer who wishes to quote brief passages in connection with a review written for inclusion in a magazine, newspaper, or broadcast.

Editorial team

Editor:

Prof. Liviu MARŞAVINA, PhD

Co-Editors:

Agnes STEPANIAN, Ladislau WALKOVSKY, Roxana Mihaela SÎRBU, Andreia Claudia LĂZĂRESCU

Layout & cover design: Eugen STAN 

Editura Politehnica
Bd. Vasile Pârvan nr. 2b
300223 Timișoara, România
Tel./Fax. 0256/404.677
E-mail: editura@upt.ro

ISSN 1841-2769
ISSN-L 1841-2769

Research
Report 2019

**Annual
Research
Report**
Politehnica
University
Timișoara
2019

Structure of the report

Introducing the Report	5
Research Centers	9
Scientific Excellence Awards	15
Projects supported by public funds	47
National Research Projects	49
Research and Development Projects for Young Researchers ...	89
International Research Projects	109
Projects supported by private funds	131
Patents	153
Granted Patents	157
Honorary Members	169
Doctor Honoris Causa	173
Honorary Professors	174
Habilitation Thesis	179
PhD Thesis	191
Scientific Conferences	199
Scientific Journals	209
ISI Papers	217
ISI Papers in highlight	221
Papers in ISI Journals	249
Papers in ISI Proceedings	265
Books	283
Politehnica University Timisoara, 1989-2019: 100 Scientific Books in Highlight	287
Books in highlight	297
Books List	301
Book Chapters List	307

Introducing the Report

“It’s not the walls that make a school, but the spirit living inside.”
King Ferdinand I, 1923

The needs for a modern society, in the context of a competitive global market, require highly skilled human resource development. In this context, the role of universities in the innovation process has increased continuously over time because the development of new products or technologies depends more and more on the findings of scientific research.

Established in 1920, shortly after the union of Romanian territories, in a European context marked by the redefinition of states and by the aftermath of World War I, the Polytechnic School in Timișoara – as it was originally called – was the answer to one of the requirements of the Romanian society of the time, namely the formation of engineers.

The mission of the Politehnica University Timișoara (UPT) is to offer nationally competitive and internationally recognized opportunities for Learning, Research, and Innovation at the highest levels of excellence. As a resource of knowledge for the public, the university builds partnerships with other educational institutions, community organizations, government agencies, and the private sector to fulfill the requirements for competences of the societal environment through superior professional training for students and graduates.

The present Research Report of Politehnica University Timișoara gathers the main results obtained through the research activities carried out within the university in 2019, Politehnica being renowned as a remarkable actor on the stage of scientific research, both at national and international level. Our research activity is facilitated by the existence of twenty-six research centres specialized in fields that are capital for the sustainable development of any modern society. Each of these research centres brings together various prestigious researchers, whom, by their effort and vision, provide UPT with the incentives needed to contribute to the progress of our society.

Most of the research activity carried out by our institution is financed through external sources, obtained either from national and international calls for projects, or through agreements with private companies. This represents a confirmation of the superior quality of the research, but also of the prestige and professional deontology of the researchers affiliated to our institution. Politehnica’s reputation as an institution of advanced research is also emphasized by the patents obtained by its researchers, by the medals and prizes obtained in both national and international competitions, and by the collaborations with important research centres and institutes from Romania and from abroad.

Each year we select the most talented young researchers for our doctoral school, providing them with the opportunity to transform their knowledge and ideas into the innovations of tomorrow. Many of them take part in peer learning programs and consolidate in this way the relationship between our university and similar partner institutions. They strive for becoming doctors in science.

This report is divided into twelve sections, each one presenting a specific component of the research activity performed within the institution.

The first section focuses on the research infrastructure, which comprises the twenty-six research centres hosted by the university. The order in which they are presented is given by the research fields. The research centres, respectively teams of researchers, on different themes, are highly important for our university since they manage to put into practice the scientific research strategy of the university successfully, within the framework of numerous grants and contracts won by competition. The research results are materialized in papers, patents and products, all bringing for the University prestige, as well as important funds.

The second section of the Research Report is dedicated to the Scientific Excellence Awards. These prestigious awards celebrate those colleagues who have made a significant contribution in their field of research and continue to inspire future generations to get involved in science.

The third and fourth sections include the research projects implemented by the university. The third section includes the projects supported by public funds, both national and international, while the fourth one includes the projects supported by private funds awarded by companies. For the purposes of this report, we have chosen the most relevant projects for our the most representative projects for our research strategy.

The innovative capacity of the Politehnica University Timișoara is supported by teachers and scientific researchers through patents and utility models invented, presented in the fifth section.

Politehnica University Timișoara recognizes scientific excellence by conferring the honorary degrees of Doctor Honoris Causa and Honorary Professor to distinguished Researchers for their contribution to the development of UPT of continuous support, as shown in section six of this Report.

Sections seven and eight include habilitation theses and PhD theses held in 2019 in our University.

Section nine presents an overview of the most relevant scientific conferences that brought together scholars and professionals from Romania and from abroad. The conferences hosted by our university encouraged the dialogue, facilitated the exchange of ideas, and offered a great opportunity for new collaborations.

The tenth section gathers the scientific journals that have been published by our institution. This category includes journals specialized in various fields, such as computer science, chemistry and environmental engineering, electronics and communications, economics and social sciences, electrical engineering, mathematics and physics, hydrotechnics, physical education and sport, modern languages, etc.

The dissemination of the research results and findings is an integral part of the research process and the career in academia. Section eleven presents the most relevant scientific researches that have been published in 2019. It comprises the results obtained by our researchers, namely the papers that obtained recognition from some of the most prestigious journals, from both Romania and abroad.

And finally the twelfth section comprises a collection of books written by our researchers, most of them published under Politehnica Publishing House.

Through research we generate ideas, through ideas we generate innovation and through innovation we contribute to the improvement of the quality of life; this is why research is our priority.

RESEARCH CENTRES



Research Institute for Renewable Energy

Director: prof. Viorel UNGUREANU
Contact: viorel.ungureanu@upt.ro, <http://www.icer.ro/>



Research Centre for Computers and Information Technology

Director: prof. Vladimir-Ioan CREȚU
Contact: vladimir.cretu@upt.ro, <http://cercetare.cs.upt.ro/>



Research Centre for Automatic Systems Engineering

Director: prof. Radu-Emil PRECUP
Contact: radu.precup@upt.ro, <http://www.aut.upt.ro/centru-cercetare/>

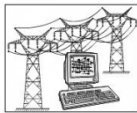

Research Centre for Power Systems Analysis and Optimization

Director: prof. Ștefan KILYENI
Contact: stefan.kilyeni@upt.ro, <http://www.et.upt.ro/index.php?sublink=1694&link=10&pag=2&lang=ro>



Research Centre for Smart Energy Conversion and Storage

Director: prof. Nicolae MUNTEAN
Contact: nicolae.muntean@upt.ro,
<http://www.et.upt.ro/index.php?link=10&sublink=1695&pag=1&lang=en>



Research Centre for Intelligent Electronic Systems

Director: prof. Marius OTEȘTEANU
Contact: marius.otesteanu@upt.ro, <http://ccesi.upt.ro/>



Research Centre for Intelligent Signal Processing

Director: prof. Alexandru ISAR
Contact: alexandru.isar@upt.ro, <http://www.tc.etc.upt.ro/ispr/>



Research Centre for Multimedia

Director: prof. Radu VASIU
Contact: radu.vasiu@upt.ro, <http://www.cm.upt.ro>



Research Centre for Environmental Science and Engineering

Director: prof. Rodica PODE
Contact: rodica.pode@upt.ro, <http://www.chim.upt.ro/ro/cercetare/centre-cercetare/centru-de-cercetare-in-stiinta-si-ingineria-mediului>



Research Centre for Inorganic Materials and Alternative Energies

Director: prof. Ioan LAZĂU

Contact: ioan.lazau@upt.ro, <http://www.chim.upt.ro/ro/cercetare/centre-cercetare/centru-de-cercetare-pentru-materiale-anorganice-si-energii-alternative>



Research Centre for Organic, Macromolecular and Natural Compounds' Chemistry and Engineering

Director: prof. Corneliu DAVIDESCU

Contact: corneliu.davidescu@upt.ro, <http://www.chim.upt.ro/ro/cercetare/centre-cercetare/centru-de-cercetare-in-chimia-si-ingineria-compusilor-organici-macromoleculari-si-naturali>



Research Centre for Mechanics of Materials and Structural Safety

Director: prof. Dan DUBINĂ

Contact: dan.dubina@upt.ro, <http://www.ct.upt.ro/centre/cemsig/>



Research Centre for Hidrotechnical Engineering and Environmental Protection

Director: prof. Constantin FLORESCU

Contact: constantin.florescu@upt.ro, <http://www.ct.upt.ro/centre/cchpm/index.htm>



Research Centre for Building Services

Director: s.l. Călin SEBARCHIEVICI

Contact: calin.sebarchievici@upt.ro, <http://www.ct.upt.ro/centre/ccic/>



Research Centre for Retrofitting of Constructions

Director: prof. Tamas NAGY GYORGY

Contact: tamas.nagy-gyorgy@upt.ro, <http://www.ct.upt.ro/centre/reco/>



Research Centre for Construction and Transportation Substructures

Director: prof. Liviu Adrian CIUTINĂ

Contact: adrian.ciutina@upt.ro, <http://www.ct.upt.ro/centre/ict/>



Research Centre for Mechatronics and Robotics

Director: prof. Inocențiu MANIU

Contact: inocentiu.maniu@upt.ro, <http://mctr.mec.upt.ro/activitate-de-cercetare>



Research Centre for Medical Engineering

Director: prof. Liviu MARȘAVINA
Contact: liviu.marsavina@upt.ro, <https://ccim.upt.ro/>



Research Centre for Integrated Engineering

Director: prof. George DRĂGHICI
Contact: george.draghici@upt.ro, <http://imf.upt.ro/CCII/index.html>



Research Centre for Processing and Characterization of Advanced Materials

Director: conf. Bogdan RADU
Contact: bogdan.radu@upt.ro, <https://sites.google.com/view/ccpcma/home>



Research Centre for Complex Fluid Systems Engineering

Director: prof. Romeo SUSAN-RESIGA
Contact: romeo.resiga@upt.ro, <https://mh.mec.upt.ro/>



Research Centre for Thermal Machines and Equipments, Transportation and Environmental Pollution Control

Director: prof. Ioana IONEL
Contact: ioana.ionel@upt.ro, <http://mettcp.mec.upt.ro/>



Research Centre for Engineering and Management

Director: prof. Claudiu Tiberiu ALBULESCU
Contact: claudiu.albulescu@upt.ro, <http://www.mpt.upt.ro/pag/centru%20cercetare.html>



Research Center in Urban Planning and Architecture

Director: prof. Smaranda BICA
Contact: smaranda.bica@upt.ro, http://www.arh.upt.ro/?page_id=3546



Research Centre for Advanced Study Methods for Physical Phenomena

Director: prof. Dumitru TOADER
Contact: dumitru.toader@upt.ro, <http://www.et.upt.ro/ro/departaments/bazele-fizice-ale-ingineriei>



Research Center for Materials and Industrial Technologies

Director: prof. Teodor HEPUȚ
Contact: teodor.heput@upt.ro, <http://www.fih.upt.ro/ccmti/>

SCIENTIFIC EXCELLENCE AWARDS

Gala Excelenței Bănățene - Banat Excellence Gala, 2019 Premiul "Traian Vuia" pentru Științe Inginerești - "Traian Vuia" Prize for Engineering Science Professor Ioan Gh. CARTIȘ, PhD

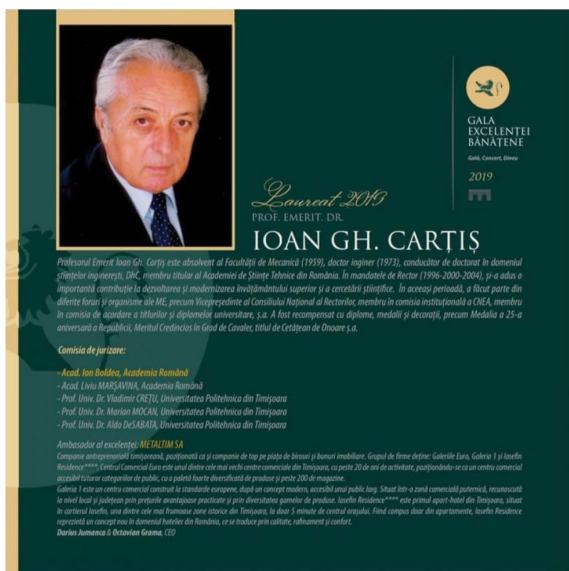

The Council for Excellence Timișoara (Romanian Academy - Timiș branch, West University Timișoara, Polytechnic University Timișoara, University of Medicine and Pharmacy Timișoara, University of Agricultural Sciences and Veterinary Medicine of Banat) organized, on December 14, 2019, the Banat Excellence Gala, dedicated to the Romanian Revolution which started in Timișoara 30 years ago.

The main objective of the Banat Excellence Gala is to highlight and recognize the personalities of Timișoara and Banat, who brought valuable achievements in their fields of activity. At this anniversary edition, the "Traian Vuia" Prize for Engineering Science was awarded on Professor Ioan Gh. Cartiș.

Professor Emeritus Ioan Gh. Cartiș is a graduate of the Faculty of Mechanics (1959), doctor of engineering (1973), doctoral supervisor in the field of engineering sciences, DhC, full member of the Romanian Academy of Technical Sciences.

During his term as Rector (1996-2000-2004), he made an important contribution to the development and modernization of higher education and scientific research. During the same period, he was part of various forums and bodies of the Ministry of Education, such as Vice President of the National Council of Rectors, member of the institutional commission of CNEA, member of the commission for awarding university degrees and diplomas, etc. He was rewarded with diplomas, medals, and decorations, such as the 25th Anniversary Medal of the Republic, the Faithful Merit in the Degree of Knight, the title of Honorary Citizen of the City of Timișoara, etc.

The members of the jury for the Engineering Science committee included Academicians Ion Boldea and Liviu Marșavina, Romanian Academy; Professors Vladimir Crețu, Marian Mocan and Aldo deSabata, Politehnică University Timișoara.



Banat Excellence Gala 2019 Romanian Academy Award Academician Dan DUBINĂ, PhD



On the occasion of the Banat Excellence Gala 2019, Academician Dan DUBINĂ was honored with the ROMANIAN ACADEMY AWARD, for his entire activity.

Academician Dan Dubină, civil engineer, graduate in 1974 of the “Traian Vuia” Polytechnic Institute in Timișoara, university professor at the Politehnica University of Timișoara. His domains of excellence in research are the stability and ductility of structures, steel structures engineering, and behavior of structures under extreme actions. He has been a member of the Romanian Academy since 2015 (corresponding member since 2010), President of the Timisoara Division of the Romanian Academy, Doctor Honoris Causa of the Technical University of Cluj-Napoca (2005), honorary member of the University of Pecs (2012).

He has published an impressive number of benchmark papers in the field of structural engineering and steel structures engineering, in prestigious international journals and with famous publishers worldwide. He is an author of inventions, evaluator of EU projects, a laureate of the European Steel Design Award, in 2003 and 2007, a member of doctoral boards in France, Belgium, Spain, Portugal, Slovenia, Hong Kong, India, Australia, a member of prestigious international institutions, organizations and professional associations in the field of civil engineering. He gave lectures and speeches at international conferences and events all over the world, in Europe, Asia, Africa, and South America. Since 1997, he has been a member of the Executive Board of the European Convention for Steel Structures, with headquarters in Brussels; he took on the presidency of the board in 2005-2006. Since 2009, he has represented Romania in COSCO – The Coal and Steel Committee of the Research Fund for Coal and Steel – RFCS.



Banat Excellence Gala 2019, PRO INVENT Exhibition 2019, University of Craiova Awards for Excellence in Research Politehnica University Timișoara

In the year 2019, Politehnica University Timișoara was awarded at various scientific events:



Timisoara Council of Excellence (Timisoara Branch of the Romanian Academy, The West University of Timisoara, Politehnica University of Timisoara, The Medicine and Pharmacy University of Timisoara, The University of Agricultural Sciences and Veterinary Medicine of Banat) organized, on December 14th, 2019, Banat Excellence Gala, a special edition dedicated to the Romanian Revolution started in Timisoara. At the Gala, The Politehnica University of Timisoara was awarded the Ambassador of Excellence Diploma.



The Special Prize PRO INVENT, awarded to the Politehnica University of Timisoara, for the inventions presented at the PRO INVENT Exhibition in 2019. The prize was awarded for the practical applicability of the inventions, for the quality of the presentation given by the PUT delegation, the large number of exhibits (stands, prototypes, products, posters), the quality of the display, and the high interest of the visitors.



The Special Prize INNOVATION AWARD from the University of Craiova to the Politehnica University, for its spirit of innovation in the field of science and implicitly for its inventions shown at the International EuroInvent 2019 Exhibition.

Romanian Academy The „Aurel Vlaicu” Prize awarded in 2019 Anghel CERNESCU, PhD & Ion DUMITRU, PhD

“Aurel Vlaicu” Award of Romanian Academy to Anghel Cernescu and Ion Dumitru for a research monograph entitled „*Fatigue of overhead power lines conductors*”.

The monograph is part of a research tradition of the Politehnica University of Timisoara in the field of mechanical strength of overhead power line conductors and cables. The book addresses a new field regarding the fatigue life of the conductors in the presence of variable amplitude loadings generated by the wind vibrations. Thus, designers, electric conductor manufacturers and those exploiting the overhead power lines are provided with a basic material for understanding and deepening the fatigue phenomenon generated by wind vibrations. The high scientific level of this book is based on considerable amount of bibliographic data, the latest computing methods and a vast experience of the authors. The cracking and fracture mechanisms of the wires in the contact area between the conductor and the clamping support are described through the notions of fretting fatigue. Also, a

series of theoretical and experimental contributions are presented in the book with the purpose of implementing within the Mechanics and Strength of Materials lab the new techniques for fatigue life evaluation of overhead power line conductors. Based on the proposed experimental method, the authors have conducted the first fatigue analysis of a 13 m long conductor (122-AL1/20-ST1A) in the presence of variable amplitude loads that simulate wind vibrations.

Fatigue of overhead power lines conductors

Authors: Anghel Cernescu, Ion Dumitru

Publisher: Romanian Academy Publishing House

Year: 2017

ISBN: 978-973-27-2783-6



Romanian Academy The „Henri Coandă” Prize awarded in 2019 Prof. Ioan SÂRBU, PhD & Lecturer Călin SEBARCHIEVICI, PhD

The Romanian Academy “Henri Coanda” prize for Technical Sciences for 2017 was awarded to the book “Solar Heating and Cooling Systems: Fundamentals, Experiments and Applications”, Elsevier, Oxford, UK, 2017, 424 pages, ISBN 978-0-12-811662-3, authors Ioan Sarbu and Calin Sebarchievici, affiliated to University Politehnica of Timisoara. The award ceremony took place in the high hall for science and culture at the General Assembly of the Romanian Academy on 12th December 2019.

This book provides a comprehensive coverage of emerging solar technologies and applications with an emphasis on heating and cooling in buildings, based on original research and the synthesis of consistent bibliographic material to meet the increasing need for modernisation and for greater energy efficiency to significantly reduce CO₂ emissions. Technical, economic, and energy saving aspects related to design, modelling, and operation of these systems is also explored. This reference includes physical and mathematical concepts developed to make this publication a self-contained and up-to-date source of information for engineers, researchers, and professionals interested in the use of solar energy as an alternative energy source.

The book, which is indexed by the ISI - Web of Science and already present in the libraries of more than 80 top universities in the world, supports the dissemination of the results of the Romanian research worldwide and the affirmation of the knowledge development in Romania.

Ioan Sarbu is a professor emeritus and doctoral degree advisor of the Department of Civil and Building Services Engineering at the Polytechnic University of Timisoara, Romania. He obtained a diploma in civil engineering from the “Traian Vuia” Polytechnic Institute of Timisoara in 1975, a PhD degree in civil engineering from the

Timisoara Technical University in 1993, and the European engineer title, designated by the European Federation of National Engineering Associations (Brussels) in 2001. His main research interests are related to refrigeration systems and heat pumps. He is also active in the field of solar energy conversion and storage and numerical simulations and optimizations in building services. He has published over 370 scientific papers in his research domains, 37 books/chapters, more than 150 articles in indexed journals and about 60 articles in proceedings of international conferences. He is also author of 6 patent certificates and up to 30 computer programs. His current h-index is 18 (Google Scholar), 14 (Scopus) and 11 (Clarivate Analytics Web of Science) as of December 2019.

Calin Sebarchievici is a lecturer of the Civil and Building Services Engineering Department and the Director of the Building Services Engineering Research Centre from the Polytechnic University of Timisoara, Romania. He obtained a diploma in building services engineering and a PhD degree in civil engineering at the Polytechnic University of Timisoara in 2003 and 2013, respectively. His research is focused on heat pumps, refrigeration systems, and solar energy conversion. He is coauthor of 4 books, 4 book chapters, 1 utility model, 19 indexed journal articles and more than 15 conference proceeding publications.



Romanian Academy The „Anghel Saligny” Prize awarded in 2019 Lect. Cristian VULCU, PhD, Assoc. Prof. Aurel STRATAN, PhD & Prof. Adrian CIUTINĂ, PhD

“Anghel Saligny” Award of Romanian Academy to Lect. Cristian VULCU, Assoc. Prof. Aurel STRATAN, Prof. Adrian CIUTINA for a series of two scientific papers entitled „Beam-to-CFT high-strength joints with external diaphragm”.



The prize regards the papers:

- Vulcu, C., Stratan, A., Ciutina, A., Dubina, D., (2017): *Beam-to-CFT High Strength Joints with External Diaphragm. I: Design and Experimental Validation*. Journal of Structural Engineering / ASCE, Vol 143/5, Article 04017001.
- Vulcu, C., Stratan, A., Ciutina, A., Dubina, D., (2017): *Beam-to-CFT High Strength Joints with External Diaphragm. II: Numerical Simulation of Joint Behavior*. Journal of Structural Engineering / ASCE, Vol 143/5, Article 04017002.

The series of two papers awarded by Romanian Academy is based on the research carried out within the framework of the European research project RFSR-CT-2009-00024 “High Strength Steel in Seismic Resistant Building Frames” HSS-SERF, funded by the Research Fund for Coal and Steel, and carried out during 2009-2013, under the coordination of Acad. Dan DUBINA (www.ct.upt.ro/centre/cemsig/hss-serf.htm).

The research topic approached by the authors aimed to broaden the scope of high-performance steels in construction. Although the metallurgical industry has developed high strength steels, they are currently only used very little in constructions and not at all in the structures located in seismic zones, mainly due to the insufficient knowledge regarding the behavior and the limitation of the seismic design codes to soft steels. The authors identified a potential for the

application of high-strength steel to the non-dissipative elements of multi-story structures (e.g. columns and joints, characterized by high strength requirements). They undertook a systematic research program, using experimental, numerical and analytical methods, resulting in the elaboration and validation of a procedure for calculating high-strength beam-to-CFT column joints for multi-story structures located in seismic zones.

The HSS-SERF research project supported also Mr. Cristian VULCU in obtaining, in 2013, his PhD degree with the thesis “Seismic performance of dual steel frames of CFRHS and welded beam-to-column joints”, under the coordination of Acad. Dan DUBINA.



Technical Sciences Academy of Romania Honorary Member Prof. Radu BĂNCILĂ, PhD

A new recognition of professional merits for a professor of the University Politehnica of Timisoara! During a solemn ceremony held in Bucharest, at the headquarters of the Romanian Academy of Technical Sciences, Professor Emeritus Radu Băncilă, from the Faculty of Constructions of UPT, was awarded the diploma of Honorary Member of ASTR, in recognition of his remarkable activity in the field of science and technology.

Prof. emeritus dr. ing. Radu Bancila is a graduate of the Timisoara Polytechnic Institute, Faculty of Constructions, class of 1967. In 1981 he came to be a Doctor of Engineering in the field of Steel Constructions. Since 1992 he became a university professor within the Faculty of Constructions, specialty - Steel Bridges. In 1997 he became a doctoral supervisor, and in 2012 he received the title of professor emeritus of the University Politehnica of Timisoara.

In 1991, Professor Radu Bancila initiated the study of civil engineering in German - founding the German Teaching Branch at the Faculty for Civil Engineering in Timisoara. Professor Bancila was the initiator of the partnership contract, in 1993, between the University Politehnica of Timisoara and the Technical University of Munich, and the department was included in the promotion program of the German Academic Exchange Service DAAD. Professor Radu Bancila, head for many years of the Civil Engineering department with teaching in German, has been involved in multilateral exchanges with the German Universities.

He is also member of many European Associations.

Professional Professor Radu Bancila is an expert in the construction of steel bridges and is involved in the development of the Romanian Railway and highway network, with new structures in innovative solutions.

He is a member or founding member of a series of international Associations of caliber in the field of construction, he has 110 scientific papers published in prestigious international journals, 10 specialized books published, 4 in English and 2 in German.

In 2012 Professor Bancila received the "Order of Merit of the Federal Republic of Germany - Class 1" from the Ambassador of the Federal Republic of Germany in Romania.



Technical Sciences Academy of Romania Honorary Member Prof. Emeritus Ioan DAVID, PhD

Prof. emeritus Ioan DAVID was elected as honorary member of the Academy of Technical Sciences Romania in the General Assembly that took place on June 2019. He is member of the Construction and Urbanism Section of the Academy of Technical Sciences.

Prof DAVID born in 1940 received the Dipl. Ing. degree in Civil engineering in 1963, the Diploma in mathematics in 1972 and the Ph.D. degree in 1973. In 1976-77 he performs a post-doctoral research program as "Alexander von Humboldt" fellow at the Technical University Darmstadt, Germany publishing the research results as Technical rapport Nr. 19, 1977 of the Hydraulic and Hydrology Department, Technical University Darmstadt (equivalent habilitation). Prof. David performed his university teaching activity as assistant professor, associate professor (1964-1989) and since 1990 as full professor and PhD scientific supervisor in Civil engineering (about 25 PhD title). In the period 1993-2005 he was visiting professor for Numerical fluid dynamic and Groundwater modelling at the Technical University Darmstadt, Germany: http://www.iib.tu-darmstadt.de/mitarbeiter_iib/team_iib.de.jsp. In October 2005 restarts his professorship at the "Politehnica University" in Timisoara, Romania until his retirement in 2010. He is since 2006 also visiting professorship at the University of Applied Science Giessen, Germany where currently give semester lectures in the field of Renewable Energy (Waterpower and Wind power).

The relevant international recognised achievements and performances in research and technic can be summarized as follow:

- *Elaboration of about 200 scientific papers* as author/co-author published in Journals and Proceedings of International Conferences (e.g. Journals of the Romanian Academy, French Academy, Russian Academy) and Proceedings of numerous International Conferences (Austria, France, Germany, Greece, Netherlands, Romania, UK, USA etc.). Several examples to publication subject are: Extension of standard integral representations for solutions of groundwater flow and transport processes coupling Analytical Element Method (AEM) and Boundary Element Method (BEM) applied in conception and implementation of complex groundwater recharge/discharge systems (e.g. Groundwater recovery/recharges systems in "Hessisches Ried" Germany). He is author/co-author of 17 books some of them publishing abroad like Groundwater Hydraulic, Springer-Vieweg, 1998, Germany; Mathematical-Numerical Modelling of Technical Systems, Couvillier-Göttingen, 2005, Germany; Basics for modelling of flood runoff using advanced Hydroinformatics tools, (2015), IGI Global, USA.
- *Coordination of laboratory experimental research programs* for sizing of various hydraulic plants in frame of over 60 implemented water engineering projects in Romania and Germany.



- *Coordination of International Cooperation Projects* among others: TEMPUS Joint European Project "Environmental Sound River Basin Development", (TU. Delft, TU Karlsruhe, TU Wien, TU Budapest, TU. Timisoara), (1991-1993); LEONARDO DA VINCI EU-Project "Development of knowledge centres for flood risk management using advanced Hydroinformatics tools" (Romania, Hungary, Czech Republic) (2012-2013) and so on.

Prof David performed notable activities in several professional and scientific organizations at national and international level as member or in leadership such as: American Romanian Academy of Arts and Sciences (ARA) vice president (2005-2009) and general secretary (2009-2013); External corporation of Hungarian Academy of Sciences (MTA) (2006); Consulting engineer in "Ingenieurkammer Hessen" (IngKH) Germany (2005); General Association of Romanian Engineers; International Association of Hydrological Sciences; European Geophysical Society; Dean of the Water Engineering faculty (UPT) (1990-2004); Scientific secretary of the Senate of Polytechnic University Timisoara; Editor in Chief of Transactions on Hydrotechnics, "Politehnica" University of Timisoara;

Prof. David obtained also several academic distinctions among another: Diploma awarded of the German Foundation "Alexander von Humboldt" for scientific research (1992); Academic title of Honorary Professor of the Technical University of Darmstadt Germany (1999); Title of Excellence from the Foundation "Polytechnica" (2010); Emeritus professor of the University "Politehnica" of Timisoara (2015); Marquis Who's Who (2006-2007) and Hübners Who's Who (2007).

International Federation for the Promotion of Mechanism and Machine Science (IFToMM) IFToMM Secretary General Prof. Erwin-Christian LOVASZ, PhD

At the 14th IFToMM World Congress, held in Krakow, Poland, between 30 June – 4 July, was elected the new Secretary General of IFToMM Prof. Erwin-Christian Lovasz from the Politehnica University of Timisoara, Romania.

The International Federation for the Promotion of Mechanisms and Machines Science (IFToMM) is one of the most important professional federation worldwide, considering the large number of national member organizations and its wide range of activities. The goal of IFToMM is to promote research and development in the field of Mechanisms and Machine Science by theoretical and experimental methods, along with their practical applications.

IFToMM was founded in 1969, in Zakopane, near Krakow, Poland, under the motto "Science without political barriers". The list of the original 13 founders is extended today to 43 national organizations, counting more than 10.000 members.

IFToMM is an organization lead by the Executive Council, which includes the President, the Vice-President, the Secretary General, the Treasurer, the Past President and six Council Members. There are four Permanent Commissions and 13 Technical Committees.

The association gathers scientists and researchers from all over the world on the occasion of different scientific events, such as conferences and summer schools organized under its patronage and an own congress, held each four years.

IFToMM is associated with Springer, that publishes a series called Mechanisms and Machine Science (presently at volume 83), which displays the proceedings of different conferences in the field. There are six important journals affiliated to IFToMM: Mechanism and Machine Theory, Open-access Mechanical Sciences, Chinese Journal of Mechanical Engineering, Advances in Vibration Engineering, MDPI journal Machines and MDPI journal Robotics.

At the 15th IFToMM World Congress, held in Krakow, Poland, between 30 June – 4 July, were elected Prof. Andres Kecskemethy (University Duisburg, Germany) as new President, Fernando Viadero-Rueda (Universidad de Cantabria, Spain) as new Vice-President, Prof. Erwin-Christian Lovasz (Politehnica University of Timisoara, Romania) as new Secretary General and Andeas Müller (Johannes Kepler Universität, Austria) as new Treasurer, for a four-year mandate (2020 – 2023).

Prof. Erwin-Christian Lovasz is an active member of the national organization ARoTMM (Asociația Română de Știința Mecanismelor și Mașinilor), whose Scientific Secretary is at present. Within IFToMM, he was Chair of the Technical Committee Linkages and Mechanical



Controls (2011-2017) and Secretary of Honors and Awards Committee (2018 – 2019).

Prof. Erwin-Christian Lovasz participated to all IFToMM World Congresses since 1995 (Milan, Italy – 1995, Oulu, Finland – 1999, Tianjin, China – 2004, Besancon, France – 2007, Guanajuato, Mexico – 2011, Taipei, Taiwan – 2015, Krakow, Poland – 2019). He initiated and organized during his chairship The First MeTrApp 2011, MAAM 2014, The Summer School MMDR 2014 and the forthcoming MTM&Robotics 2020 at the Politehnica University of Timisoara, bringing to our university international recognition and prestige.

The election of Prof. Erwin-Christian Lovasz in the highest leading structures of IFToMM, as a proof of his professional and managerial recognition at international level, honors the organizations he represents, namely the Politehnica University of Timisoara and the national organization ARoTMM and, subsequently, Romania.



BIG SEE Architecture Festival BIG SEE Architecture Award 2019 - WINNER Prof. Arch. Vlad GAIVORONSKI, PhD



With its work "HOME OF ART", a residential project in Timisoara, prof. arch. ph.d. Vlad GAIVORONSKI was declared WINNER at residential architecture category at BIG SEE Architecture Festival in Ljubljana on 17 april 2019.

BIG SEE is an annual international event which systematically explores, evaluates, exposes promotes and develop business and creative excellence from South-East Europe.

It brings together 19 countries and 350 million people. The countries invited to the event are: Albania, Austria, Bulgaria, Bosnia and Herzegovina, Cyprus, Czech Republic, Greece, Croatia, Italy, Hungary, Kosovo, North Macedonia, Moldova, Montenegro, Romania, Slovakia, Slovenia, Serbia and Turkey.

BIG SEE platform represents an unique forum and community for discussion and development of the cultural, economic and political role of the region and its importance and impact on the globalised world.

BIG SEE AWARDS are intended to research, promote and connect authors, investors and partners in various projects and expose the architectural excellence of the Southeast Europe.

In the last decades, Vlad Gaivoronschi obtained also other international recognition, as The European Prize for Steel Construction ECCS in 1997, Nominations at European Architecture Prize "Mies van der Rohe" Barcelona in 2008 and 2010, Shortlisting at World Architecture Festival in 2010 in Barcelona and 2016 in Berlin and Winner at German Design Awards in 2018 and 2020 in Frankfurt.



7th International Conference on Information Technology and Quantitative Management ITQM 2019 Best Paper Award

Raul-Cristian ROMAN, Radu-Emil PRECUP, Claudia-Adina BOJAN-DRAGOȘ & Alexandra-Iulia SZEDLAK-STÎNEAN

The team consisting of As.Dr.Ing. Raul-Cristian ROMAN, Prof.Dr.Ing. Radu-Emil PRECUP, Ș.I.Dr.Ing. Claudia-Adina BOJAN-DRAGOȘ, Ș.I.Dr.Ing. Alexandra-Iulia SZEDLAK-STÎNEAN received “Best Paper Award” for the paper “Combined Model-Free Adaptive Control with Fuzzy Component by Virtual Reference Feedback Tuning for Tower Crane Systems” presented at the 7th International Conference on Information Technology and Quantitative Management ITQM, which took place in Granada, Spain, in November 03-06, 2019. (<http://itqm-meeting.org/2019/>)

The International Conference on Information Technology and Quantitative Management (ITQM), established by International Association of ITQM (IAITQM), is a global forum for exchanging research findings and case studies that bridge the latest information technology and quantitative management techniques. It explores how the use of information technology to improve quantitative management techniques and how the development of management tools can reshape the development of information technology. This conference is focused on exploring innovations, controversies, and challenges facing our scientific community today. The theme of ITQM 2019 is “Information technology and quantitative management based on Artificial Intelligence”.

Three specific optimization problems are defined and solved by Model-Free Adaptive Control, VRFT and GWO algorithms. The novel algorithm is validated using experimental results to the arm angular position of the nonlinear tower crane system laboratory equipment.

This work was supported in part by the Romanian research grants GNaC2018-ARUT, no. 1348/01.02.2019, CNCS - UEFISCDI PN-III-P1-1.1-PD-2016-0331, within PNCDI III, and the grant CNFIS-FDI-2019-0696.



The paper proposes a novel mix of two data-driven algorithms. The purpose of mixing the algorithms is to exploit the main advantage of data-driven Virtual Reference Feedback Tuning (VRFT) algorithm, represented by the automatic computation of the optimal parameters using metaheuristic Grey Wolf Optimizer (GWO) for the Compact Form Dynamic Linearization (CFDL) version of the authors’ Model-Free Adaptive Control Takagi-Sugeno Fuzzy Algorithm (CFDL-PDTSFA), and the parameters of the CFDL-PDTSFA are optimally tuned in a model-free manner using VRFT.

6th International SGEM Conference on Social Sciences and Arts Best Presentation Award Assoc. Prof. Mariana CERNICOVA-BUCĂ, PhD

Assoc. Prof. Mariana CERNICOVA-BUCĂ, PhD, from the Faculty of Communication Sciences (UPT), obtained the Best Presentation Award for the paper "Tentative Conclusions Regarding the Ascension of Community Supported Agriculture in Romania" at the 6th International SGEM Conference on Social Sciences and Arts, which took place in Albena, Bulgaria in August 24–September 2, 2019 (<http://sgemsocial.org/>). The SGEM International Conferences on Social Sciences and Arts are organized under the aegis of 18 national academies from three continents and examine the nature of disciplinary and interdisciplinary scientific concepts that arise in the context of 'real world' applications. The focus of the papers ranges from the finely grained and empirical principles to wide-ranging multidisciplinary practices and perspectives on knowledge and method.

The paper presented by assoc. prof. Mariana Cernicova-Bucă is based on case studies analyzing the concept of community supported agriculture (CSA) implemented in Romania since 2008, in connection with such topics as ethical consumption, solidarity and revival of traditional values, from a communication point of view. The communication campaigns and the projects that supported the promotion of this type of relations still rely mainly on a tiny layer of consumers, ready to share the philosophy behind new types of economic relations, where ethical considerations, solidarity and trust represent core values. The CSA model remains an early attempt to introduce new patterns of economic relations in Romania, in the larger trend of fair trade and responsible consumption.

The "Best presentation award", bearing a diploma and an engraved crystal trophy, is awarded at the proposal of the section moderators in which the papers are presented. The titles are presented to the laureates at a festive ceremony, at the end of the multidisciplinary conference and disseminated through the conference website:

<https://sgemsocial.org/index.php/committee/sgem-award-certificate>

The distinguished paper, bearing the DOI number 10.5593/SWS.ISCSS.2019.3/S12.096 is published in the Conference Proceedings Volume "6th SWS International Scientific Conference on Social Sciences ISCSSL 2019" Book 3 (ISSN 2682-9959) and is subjected to indexing in ISI Web of Knowledge, Clarivate Analytics, ELSEVIER products Mendeley, CrossRef, EBSCO, ProQuest, RSCI, Google Scholar, CiteUlike, CrossRef Citedby Linking, British Library, etc.



TIMTED 2019 International Conference “Current economic trends in emerging and developing countries” Best Paper Award Prof. Claudiu ALBULESCU, PhD

The paper entitled “CO2 emissions, renewable energy production and environmental regulation in the EU countries” (authors Claudiu ALBULESCU, Caius LUMINOSU, Alin ARTENE and Matei TĂMĂȘILĂ) received the distinction of “Best Paper Award”, delivered by Scientific Committee of the TIMTED 2019 International Conference “Current economic trends in emerging and developing countries”, held in Timișoara, on 16 to 18 May 2018.

The purpose of TIMTED 2019 International Conference was to share most recent developments in the fields of economics and business, with a focus on emerging and developing economies. The TIMTED conference is organized every two years by the Faculty of Economics and Business Administration, West University of Timișoara, and benefits from noteworthy international participation and reputed keynote speakers.

The research conducted within the paper presented at TIMTED 2019 International Conference was supported by a grant of the Romanian National Authority for Scientific Research and Innovation, CNCS-UEFISCDI, project number, PN-II-RU-TE-2014-4-1760, project entitled “The impact of the economic and financial stability on investments, innovation process and entrepreneurial activity in the EU” (Director, Prof. Claudiu ALBULESCU).

The paper is accepted for publication in “Environmental Science and Pollution Research”.



47th International Exhibition of Inventions Geneva 2019 Gold Medal, Taiwan Medal, “Vincit Amor Patriae” Medal & Diplomas Roland SZABO, PhD & Aurel GONTEAN, PhD

The event 47th International Exhibition of Inventions of Geneva took place in Switzerland, in the period of 10-14 April, 2019, where the following invention was presented: PORTABLE FLASH MEMORY ON THE ETHERNET INTERFACE.

The prizes won at this event are the following:

- Diploma of the 47th International Exhibition of Inventions of Geneva 2019, accompanied by a gold medal with congratulations of the jury;
- Special award from the Taiwan Inventions Association with a diploma and medal;
- “Vincit Amor Patriae” award from the Romanian Research and Innovation Minister with a diploma and medal.

The authors of the invention presented the invention at this event and carried out their professional activity in the Politehnica University Timișoara, Faculty of Electronics, Telecommunications and Information Technologies, Applied Electronics Department.

The invention relates to a portable flash memory on an Ethernet interface, designed to increase the transfer speed when copying small files and / or increasing the transfer distance.

The advantages of this invention are as follows:

- The possibility to have a portable flash memory type with much faster write / read speed (even for many and small files) than the other solutions of portable flash memories on USB interface;
- Simplicity;
- Compatibility with existing switches and PCs.



33th International Festival of Innovation, Knowledge and Creativity TESLA FEST, October 12-15, 2019, Novi Sad, Serbian Republic Multiple medals for Politehnica University Timisoara

This event was organised under the auspices of the Government of the Serbian Republic, Government of AP Vojvodina and the city of Novi Sad. The works presented on this occasion (and registered with the O.S.I.M. under the tutelage of UPT) in the form of a poster, were appreciated by an international jury and the visiting public. At the same time, the UPT stand was visited and appreciated by Dr. Ștefan IMRE, counselor of the minister from the Embassy of Romania – Belgrade, Serbian Republic. I also gave an interview to the reporter from *Novi Sad television and radio – Romanian language department*, the reportage was presented in the date of 13.10.2019 (http://media.rtv.rs/sr_ci/magazin-tv/50590). Reporter Marina ANCAITAN wrote the article: "TIME JUDGES US AND THE FACTS SPEAK" in the newspaper *LIBERTY*, (the newspaper of the romanians from Serbia) article printed in no. 44 (4021), in the date of 02.11.2019, page 15, in which are mentioned and appreciated the presented works (<https://libertatea.rs/dr-ing-pavel-stefan-timpul-ne-judeca-iar-faptele-vorbesc/>). Following the judging, all the presented works obtained 7 GOLD medals, and 3 SILVER medals (<http://teslafest.com/>).

The presented works were the following:

1. Electric installation for dental medical units air disinfection
 - Inventors: Stefan PAVEL, Ancuta Letitia TUTELCA, Deian Adrian JIFCU, Eugen-Florin LACATUSU, Andrei ADAM, Daliborca Cristina VLAD, Victor DUMITRASCU, Elena HOGEA, Iconia Ecaterina BORZA si Silviu Cristian SUCIU
 - Gold Medal
2. Instalation for the evaluation of the magnetic field exposure effects
 - Inventors: Stefan PAVEL, Lavinia Afrodita LUPA, Marian Liviu MOCAN, Daniel Viorel UNGUREANU, Ioan Silviu DOBOSI, Aurel MOLDOVAN, Alina Georgiana SIMINA, Alexandru BINZAR, Silviu Cristian SUCIU
 - Gold Medal and Diploma of Excellence - Banat's University of Agricultural Sciences and Veterinary Medicine "King Michael I of Romania" from Timisoara
3. Earthing electrode with corrosion resistant connection
 - Inventors: Stefan PAVEL, Daniel-Viorel UNGUREANU, Marian Liviu MOCAN, Ioan Silviu DOBOSI, Florin-Ionel TOPALA
 - Gold Medal
4. Lighting system for the "Ceramic room" compartment of the dental laboratories
 - Inventors: Stefan PAVEL, Ioan BORZA, Emanuel Adrian BRATU, Ioan Silviu DOBOSI, Paulina Ioana GAINA, Felicia STREIAN, Serban TALPOS-NICULESCU
 - Gold Medal
5. Portable device for signaling pain, sensivity or discomfort during the course of medical dentar activity
 - Inventor: Stefan PAVEL
 - Gold Medal
6. Mobile installation used for the support of the child during the pediatric radiology
 - Inventors: Stefan PAVEL, Calin Marius POPOIU, Marian Liviu MOCAN, Ioan Silviu DOBOSI, Dan-Andrei SERBAN
 - Gold Medal
7. Device for the disinfection surface in enclosed environments
 - Inventors: Stefan PAVEL, Silviu-Cristian SUCIU
 - Gold Medal
8. Compressed air system for dental units
 - Inventors: Stefan PAVEL, Ioan BORZA
 - Silver Medal
9. Electrical light installation for dental esthetics
 - Inventors: Stefan PAVEL, Cristina KREMS, Marian Liviu MOCAN, Ioan Silviu DOBOSI
 - Silver Medal
10. Waste water decontamination system in the dental unit
 - Inventors: Stefan PAVEL, Ioan BORZA, Emanuel Adrian BRATU, Ioan Silviu DOBOSI, Paulina Ioana GAINA, Felicia STREIAN, Serban TALPOS-NICULESCU
 - Silver Medal



PRO INVENT International Exhibition of Scientific Research, Innovation and Inventions, 17th edition, March 2-22, 2019, Cluj-Napoca Multiple medals for Politehnica University Timisoara

The PRO INVENT Salon from Cluj-Napoca was and wishes to remain a distinct meeting place between the inventors and inventions and the businessmen and entrepreneurs interested in implementing the results of human research, innovation and human creativity.

Innovative companies wishing to present new products and technologies can do so in a separate section, commonly called the "Technology Arena," which provides an opportunity for participating companies to present to the audience both innovative technical solutions created already and the medium to long-term innovation strategy. Also inventors will have an exclusive space called the "Inventors Arena" where they can expose and share ideas from various domains.

Salon theme: innovative materials, processes and products (energy, environment, health, agriculture, resources, etc.).

Graphic presentations accompanied by models, prototypes, finished products, video presentations, as well as data on the social, financial impact of the work will enjoy the express appreciation of the jury.

The stand of Politehnica University Timișoara, one of the most important in the Salon, was rewarded with the following awards:

1. Integrated thermal deflector

- Inventor: Corneliu BIRTOK BĂNEASĂ
- Gold Medal and Diploma of Excellence INMA - National Research and Development Institute for Machinery and Installations for Agriculture and Food Industry

2. Tubular lighter from powdered ferrous waste

- Inventors: Teodor HEPUȚ, Ana SOCALICI, Erika ARDELEAN, Marius ARDELEAN, Nicolae CONSTANTIN, Miron BUZDUGA, Radu BUZDUGA
- Pro Invent Medal and Excellence Award University of Agronomic Sciences and Veterinary Medicine in Bucharest - USAMV

3. Installation for determining the resistance to thermal fatigue

- Inventor: Camelia PINCA- BRETOTEAN
- Pro Invent Medal

4. R.I.M.S. Air by Corneliu

- Inventor: Corneliu BIRTOK BĂNEASĂ
- Pro Invent Medal and Special Award SPWIR (Inventor's Association from Poland)

5. "DEXTER"'s Laboratory

- Inventors: Corneliu BIRTOK BĂNEASĂ, Adina BUDIUL BERGHIAN
- Special Award Romanian Association for Unconventional Technologies - ARTN

6. MicroU

- Inventor: Corneliu BIRTOK BĂNEASĂ
- Diploma of Excellence Justin Capră Association

7. Bircor

- Inventor: Corneliu BIRTOK BĂNEASĂ
- Excellence Award University of Agronomic Sciences and Veterinary Medicine in Bucharest - USAMV



International Exhibition of Inventions and Innovations “Traian Vuia” Timișoara, 5th edition, June 12-14, 2019, Timișoara Multiple medals for Politehnica University Timisoara

Politehnica University Timisoara has once again confirmed its potential for innovation. At the 5th edition of the “Traian Vuia” International Salon for Inventions and Innovations Timișoara, which took place for three days between June 12 and 14, 2019 at the Youth House, UPT had a remarkable presence, exposing 21 inventions.

The Grand Prize of the International Traian Vuia Salon was awarded to Politehnica University Timisoara. The report of the UPT delegation also includes 14 gold medals, 4 silver medals, 3 bronze medals, 10 special prizes and 6 diplomas of excellence.

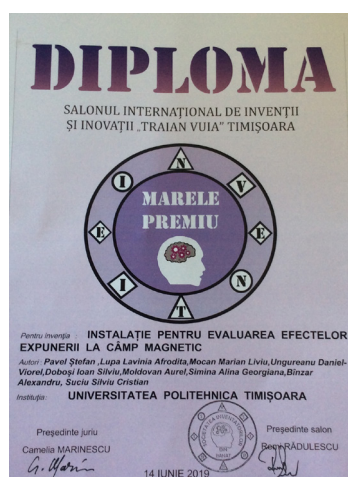

The stand of Politehnica University Timișoara, one of the most important in the Salon, was rewarded with the following awards:

- Installation for evaluating the effects of exposure to magnetic field
 - Inventors: Ștefan PAVEL, Lavinia Afrodita LUPA, Marian Liviu MOCAN, Daniel-Viorel UNGUREANU, Ioan Silviu DOBOȘI, Aurel MOLDOVAN, Alina Georgiana SIMINA, Alexandru BÎNZAR, Silviu Cristian SUCIU
 - Gold Medal, IDEA Special Award, Special Award University of Medicine and Pharmacy “Victor Babeș” Timisoara and Grand Prize of the International Salon of Inventions “Traian Vuia” 2019
- Construction ground electrode with corrosion-resistant connections
 - Inventors: Ștefan PAVEL, Daniel-Viorel UNGUREANU, Marian Liviu MOCAN, Ioan Silviu DOBOȘI, Florin-Ionel TOPALĂ
 - Gold Medal and Special Prize of the Polytechnic University of Bucharest
- Integrated thermal deflector
 - Inventor: Corneliu BIRTOK BĂNEASĂ
 - Gold Medal and Special Award NATIONAL RESEARCH AND DEVELOPMENT INSTITUTE FOR MECHATRONICS AND MEASUREMENT TECHNIQUE INCDMTM BUCHAREST
- Process for treating residues from the incineration of households waste by solidification-stabilization in ash rock
 - Inventors: Mihail Reinhold WÄCHTER, Ioana IONEL, Adina NEGREA
 - Gold Medal and IDEA Special Award - Diploma awarded by Ötlet Club 13 Egyesület
- Tubular lighter from powdery ferrous waste
 - Inventors: Teodor HEPUȚ, Ana SOCALICI, Erika ARDELEAN, Marius ARDELEAN, Nicolae CONSTANTIN, Miron BUZDUGA, Radu BUZDUGA
 - Gold Medal
- R.I.M.S. AIR by CORNELIU
 - Inventator: Corneliu BIRTOK BĂNEASĂ
 - Gold Medal, ISIM Special Award and Diploma of Excellence Petroșani University
- Installation for determining the resistance to thermal fatigue
 - Inventor: Camelia PINCA- BRETOTEAN
 - Gold Medal

8. Process for the synthesis of silver nanowires coated with low melting point metal nanoparticles

- Inventors: Radu Nicolae BĂNICĂ, Andrea Rozalia KELLENBERGER, Daniel Horațiu URSU, Liliana CSEH, Petrică Andrei LINUL, Nicolae VASZILCSIN
- Gold Medal and OSIM Special Award

9. FSU Suction air filter

- Inventor: Corneliu BIRTOK BĂNEASĂ
- Gold Medal

10. Inverted suction filter

- Inventor: Corneliu BIRTOK BĂNEASĂ
- Gold Medal

11. W Suction air filter

- Inventor: Corneliu BIRTOK BĂNEASĂ
- Gold Medal

12. Dynamic air transfer system

- Inventor: Corneliu BIRTOK BĂNEASĂ
- Gold Medal and ARTN Special Award

13. Novel modular stack design for high Pressure PEM water electrolyzer technology with wide operation range and reduced cost (PRETZEL)

- Project team coordinated by Andrea KELLENBERGER
- Gold Medal

14. Portable flash memory, "stick" type, on Ethernet interface

- Inventors: Roland SZABO, Aurel GONTEAN
- Gold Medal and Special Award National Research and Development Institute for Mechatronics and Measurement Technique INCDMTM Bucharest

15. "DEXTER"'s Laboratory

- Inventors: Corneliu BIRTOK BĂNEASĂ, Adina BUDIUL BERGHIAN
- Silver Medal and Diploma of Excellence University of Agricultural Sciences and Veterinary Medicine of Banat "King Mihai I of Romania" in Timisoara – USAMVB / Justin Capra

16. Bircor

- Inventor: Corneliu BIRTOK BĂNEASĂ
- Silver Medal

17. RoboFIH Team

- Inventor: Ovidiu TIRIAN
- Silver Medal

18. Power steering- "DEXTER"'s Laboratory

- Inventors: Amalia DASCĂL, Corneliu BIRTOK BĂNEASĂ
- Silver Medal

19. MicroU

- Inventor: Corneliu BIRTOK BĂNEASĂ
- Bronze Medal

20. AC Installation—experimental stand

- Inventor: Vasile ALEXA
- Bronze Medal

21. GPL supply plant – "DEXTER"'s Laboratory

- Inventors: Sorin RAȚIU, Corneliu BIRTOK BĂNEASĂ
- Bronze Medal



European Exhibition of Creativity and Innovation - EUROINVENT, May 16-18, 2019, Iași Multiple medals for Politehnica University Timisoara

The Exhibition promotes the International and Romanian creativity in European context by displaying the contributions of consecrated schools of higher education and academic research and also of individual inventors. In this way, at the exhibition are participating researchers and inventors through associations, foundations or institutions specialized on development and creativity.

While the economic crisis continues to get worse, creativity and innovation are the key to strengthen Europe's development. Creativity and innovation contribute to economic prosperity as well as to social and individual well-being.

Innovative Researches where Students, MsD, PhD and Post Doc researchers were able to present their projects. The International Jury evaluated all registrations and will award Diplomas, Medals and Prizes. All the inventions and research details have been published in EUROINVENT Catalogue (ISBN).

The stand of Politehnica University Timișoara was rewarded with the following awards:

1. Tubular lighter from powdery ferrous waste
 - Inventors: Teodor HEPUȚ, Ana SOCALICI, Erika ARDELEAN, Marius ARDELEAN, Nicolae CONSTANTIN, Miron BUZDUGA, Radu BUZDUGA
 - Gold Medal
2. Installation for determining the resistance to thermal fatigue
 - Inventor: Camelia PINCA BRETOTEAN
 - Gold Medal
3. Suction filter FSU
 - Inventor: Corneliu BIRTOK BĂNEASĂ
 - Gold Medal
4. Dynamic air transfer system
 - Inventor: Corneliu BIRTOK BĂNEASĂ
 - Gold Medal
5. Synthesis process of silver nanowires coated with low melting point metal nanoparticles
 - Inventors: Radu Nicolae BĂNICĂ, Andrea Rozalia KELLENBERGER, Daniel Horațiu URSU, Liliana CSEH, Petrică Andrei LINUL, Nicolae VASZILCSIN
 - Silver Medal and Diploma of Excellence with Medal awarded by the State University of Medicine and Pharmacy "Nicolae Testemitanu" from the Republic of Moldova, Diploma of Excellence awarded by the University of Wallachia Targoviste Research Center "Nanomaterials for mechanical microsystems"
6. R.I.M.S. Air by Corneliu
 - Inventor: Corneliu BIRTOK BĂNEASĂ
 - Silver Medal, Dorel Cernomazu Special Award Ștefan cel Mare University of Suceava - USV, Certificate of Excellence - Petroșani University, Certificate of Excellence Romanian Institute for Research and Advanced Studies - IRSCA
7. Suction filter W
 - Inventor: Corneliu BIRTOK BĂNEASĂ
 - Silver Medal and Technical University of Cluj Napoca - UTC Special Award
8. MicroU
 - Inventor: Corneliu BIRTOK BĂNEASĂ
 - Bronze Medal and Special Excellence Innovation Award - Polytechnic University of Bucharest
9. Bircor
 - Inventor: Corneliu BIRTOK BĂNEASĂ
 - Bronze Medal
10. "DEXTER"'s Laboratory
 - Inventors: Corneliu BIRTOK BĂNEASĂ, Adina BUDIUL BERGHIAN
 - Special Innovation Award & Gold Medal - University of Craiova, HOFIGAL Diploma of Excellence and Diploma of Excellence National Research - Development Institute for Machines and Installations for Agriculture and Food Industry - INMA
11. Integrated thermal deflector
 - Inventor: Corneliu BIRTOK BĂNEASĂ
 - Special Prize Polytechnic INNOVATION AWARD awarded by the Polytechnic University of Bucharest
12. Inverted suction filter
 - Inventor: Corneliu BIRTOK BĂNEASĂ
 - Special Excellence Innovation Award - Polytechnic University of Bucharest

The International Fair of Inventions and Practical Ideas INVENT-INVEST, May 7-9, 2019, Ploiești Diplomas and medals for Politehnica University Timisoara

The event The International Fair of Inventions and Practical Ideas INVENT-INVEST took place in Ploiești in the period of 7-9 may 2019, inside the Petrol-Gas University of Ploiești and it was organised by the Petrol-Gas University of Ploiești, the Romanian Inventors Society and "Gheorghe Asachi" Technical University of Iași.

The presented works under the tutelage of Politehnica University of Timișoara were appreciated and awarded with the Diploma of Excellence with the medal of honor of the INVENT-INVEST fair, the Diploma of Excellence (Chamber of Commerce and Industry of Prahova), Certificate of Excellence (Justin Capra Inventors Association) and Diploma of Excellence (Prahova County Council, Prahova County Natural Sciences Museum).

1. Portable device for signaling pain,

- Inventor: Ștefan PAVEL;
- Diploma of Excellence with the medal of honor of the INVENT-INVEST fair;



3. Compressed air system for dental units,

- Inventors: Ștefan PAVEL, Ioan BORZA,
- Certificate of Excellence (Justin Capra Inventors Association);



2. Earthing electrode with corrosion resistant connection,

- Inventors: Ștefan PAVEL, Daniel-Viorel UNGUREANU, Marian Liviu MOCAN, Ioan Silviu DOBOȘI, Florin-Ionel TOPALA
- Diploma of Excellence (Chamber of Commerce and Industry of Prahova);



Diploma awarded for the participation at The International Fair of Inventions and Practical Ideas INVENT-INVEST, Ștefan PAVEL, Diploma of Excellence (Prahova County Council, Prahova County Natural Sciences Museum)



„Orizonturi Universitare” Association Prize and Diploma „Eminent Researcher 2019” Assoc. Prof. Călin-Adrian POPA, PhD

Călin-Adrian Popa is an Associate Professor at the Department of Computers and Information Technology from the Faculty of Automation and Computers. His research activity is mainly focused on the field of machine learning in general, and neural networks in particular. He was awarded the Prize and Diploma „Eminent Researcher 2019” for Remarkable results in the academic activity by the „Orizonturi Universitare” Association.

During his academic career, he published, as the only author (with 2 exceptions), 5 papers in ISI journals in the Q1 quartile, and 1 paper in an ISI journal in the Q2 quartile, 2 of them at the famous journal Neural Networks, which had an impact factor of 7,19. He also published, as the only author (with one exception), 30 papers at ISI conferences, 7 of them at the famous International Joint Conference on Neural Networks (IJCNN), the most important and prestigious conference in the field of neural networks.

He was the director of the project PCD-TC-2017-41, granted in the internal competition „Proiecte de Cercetare, Dezvoltare pentru Tineri Cercetători (PCD-TC)” (Projects of Research, Development for Young Researchers), organized by the Politehnica University Timișoara. As a recognition of his research activity, he was appointed reviewer for 16 ISI journals in the Q1 quartile and for 3 ISI journals in the Q2 quartile, including the famous journal IEEE Transactions on Neural Networks and Learning Systems, which has an impact factor of 11,68.



Politehnica University Timișoara Award for EXCELLENCE IN RESEARCH Lecturer Anamaria TODEA, PhD

At the end of the year, Politehnica University Timișoara awarded the “Excellence in Research” prizes to young people who achieved remarkable results during the academic year 2018–2019.

Anamaria Todea is Lecturer at the Department of Applied Chemistry and Engineering of Organic and Natural Compounds from the Faculty of Industrial Chemistry and Environmental Engineering. Her research activity occurs in the Biocatalysis Group led by Prof. Dr. Eng. Francisc Peter from Politehnica University and it is focused on the field of biotechnology and biocatalysis, mainly in enzymatic synthesis and characterization of some biomaterials using renewable raw materials and development and characterization of stable and personalized biocatalysts.

During the 2018–2019 year, she published as first/corresponding author 4 papers in ISI journals in the Q1 quartile and 1 paper in an ISI journal in the Q2 quartile. One of the papers published in *Biotechnology Journal* was selected as Front Cover of the Journal no 6/2018. She has an Hirsh Index of 6. Her results were presented in this period at 3 prestigious European International Conferences. In the same period she was reviewer for 3 ISI journals in the Q2 quartile.



Politehnica University Timișoara Award for EXCELLENCE IN RESEARCH Lector Lavinia-Afrodita LUPA, PhD

At the end of the year, Politehnica University Timișoara awarded the “Excellence in Research” prizes to young people who achieved remarkable results during the academic year 2018-2019.

Lavinia-Afrodita Lupa is lector at the Faculty of Industrial Chemistry and Environmental Engineering. Her research activity is mainly carried out in the field of environmental engineering, in close correlation with chemical engineering. In the year 2018-2019 she published 16 articles in ISI journals, from which at 3 as first author and at 2 as the corresponding author. Her main research area is represented by the water treatment technologies using adsorption processes. In this direction she has been continuously concerned with obtaining and developing new viable, efficient and economical adsorbent materials, by reclaiming different wastes and by-products resulting from different industrial branches. The useful elements from waste

resulted, especially from hot -dip galvanizing processes, were reclaimed as layered double hydroxides and used with success in different adsorption or photocatalytic processes. In order to improve the adsorbent capacities of the studied materials, in the last years she has focused on the use of ionic liquids as green extractants in the removal processes of pollutants from water. In this direction she published as first author a manuscript in the journal of Separation and Purification Technology, Q1 quartile having an impact factor of 5.107. The importance and novelty of the experimental studies presented in this article are underlined by the large number of citations gathered in one year since publication, namely 18 (without self-citations).



EXECUTIVE UNIT FOR FINANCING HIGHER EDUCATION, RESEARCH, DEVELOPMENT AND INNOVATION - UEFISCDI AWARDS - ARTICLES

Through these awards UEFISCDI aims to increase quality, impact and international visibility of Romanian research by recognizing and rewarding significant results published in prestigious journals from international senior scientific stream.

Within this competition can participate the researchers affiliated to institutions in Romania, authors of scientific articles published in journals indexed by Clarivate Analytics Science Citation Index Expanded ("Science"), Social Sciences Citation Index ("Social Sciences") or Arts & Humanities Citation Index ("Arts & Humanities").

More information at <http://uefiscdi.gov.ro/Public/cat/471/Premierea-rezultatelor-cercetarii.html>

1. Ancuti, C., Ancuti, C.O., de Vleeschouwer, C., Sbert, M. Decolorization by Fusion, IEEE ACCESS, Volume: 6, Pages: 64071-64084, ISSN: 2169-3536, 2018;
2. Belega, D., Petri, D. Effect of windowing and noise on the amplitude and phase estimators returned by the Taylor-based Weighted Least Squares, DIGITAL SIGNAL PROCESSING, Volume: 83, Pages: 202-213, ISSN: 1051-2004, eISSN: 1095-4333, 2018;
3. Buse, C., Nguyen, L.T., O'Regan, D. GLOBAL AND LOCAL VERSIONS FOR A PHONG VU THEOREM FOR PERIODIC EVOLUTION FAMILIES IN HILBERT SPACES, ELECTRONIC JOURNAL OF DIFFERENTIAL EQUATIONS, Article Number: 188, ISSN: 1072-6691, 2018;
4. Linul, E., Valean, C., Linul, P.A. Compressive Behavior of Aluminum Microfibers Reinforced Semi-Rigid Polyurethane Foams, POLYMERS, Volume: 10, Issue: 12, Article Number: 1298, ISSN: 2073-4360, 2018;
5. Marinca, V., Marinca, B. OPTIMAL AUXILIARY FUNCTIONS METHOD FOR NONLINEAR THIN FILM FLOW OF A THIRD GRADE FLUID ON A MOVING BELT, PROCEEDINGS OF THE ROMANIAN ACADEMY SERIES A-MATHEMATICS PHYSICS TECHNICAL SCIENCES INFORMATION SCIENCE, Volume: 19, Issue: 4, Pages: 575-580, ISSN: 1454-9069, 2018;
6. Muntean, E., Stoia, M., Pacurariu, C. Facile synthesis, characterization and magnetic properties of manganese ferrite/carbon composites, THERMOCHIMICA ACTA, Volume: 667, Pages: 122-131, ISSN: 0040-6031, eISSN: 1872-762X, 2018;
7. Oncioiu, I., Grecu, E., Masu, S., Morariu, F., Popa, M. The effect of fly ash on sunflower growth and human health, ENVIRONMENTAL SCIENCE AND POLLUTION RESEARCH, Volume: 25, Issue: 35, Special Issue: SI, Pages: 35548-35554, PubMed ID: 30350152, ISSN: 0944-1344, eISSN: 1614-7499, 2018;
8. Pana, A., Baloi, A., Molnar-Matei, F. Iterative Method for Determining the Values of the Susceptances of a Balancing Capacitive Compensator, ENERGIES, Volume: 11, Issue: 10, Article Number: 2742, ISSN: 1996-1073, 2018;
9. Radac, M.B., Precup, R.E. Data-driven MIMO model-free reference tracking control with nonlinear state-feedback and fractional order controllers, APPLIED SOFT COMPUTING, Volume: 73, Pages: 992-1003, ISSN: 1568-4946, eISSN: 1872-9681, 2018;
10. Svera, P., Niznansky, D., Stefanut, M.N., Ursu, D., Sfirloaga, P., Dabici, A., Taranu, B.O., Putz, A.M., Serban, V.A. Studies on the hydrothermal synthesis of CdxZn1-xS compounds, PROCESSING AND APPLICATION OF CERAMICS, Volume: 12, Issue: 3, Pages: 288-295, ISSN: 1820-6131, eISSN: 2406-1034, 2018;
11. Topirceanu, A. Competition-Based Benchmarking of Influence Ranking Methods in Social Networks, COMPLEXITY, Article Number: 4562609, ISSN: 1076-2787, eISSN: 1099-0526, 2018;
12. Topirceanu, A., Udrescu, M., Udrescu, L., Ardelean, C., Dan, R., Reisz, D., Mihaicuta, S. SAS score: Targeting high-specificity for efficient population-wide monitoring of obstructive sleep apnea, PLOS ONE, Volume: 13, Issue: 9, Article Number: e0202042, PubMed ID: 30183715, ISSN: 1932-6203, 2018;
13. Zub, C.I., Stratan, A., Dogariu, A., Dubina, D. DEVELOPMENT OF A FINITE ELEMENT MODEL FOR A BUCKLING RESTRAINED BRACE, PROCEEDINGS OF THE ROMANIAN ACADEMY SERIES A-MATHEMATICS PHYSICS TECHNICAL SCIENCES INFORMATION SCIENCE, Volume: 19, Issue: 4, Pages: 581-588, ISSN: 1454-9069, 2018;

No.

UEFISCDI Awards

14. Aliha, M.R.M., Mousavi, S.S., Bahmani, A., Linul, E., Marsavina, L. Crack initiation angles and propagation paths in polyurethane foams under mixed modes I/II and I/III loading, THEORETICAL AND APPLIED FRACTURE MECHANICS, Volume: 101, Pages: 152-161, ISSN: 0167-8442, eISSN: 1872-7638, 2019;
15. Ancuti, C.O., Ancuti, C., De Vleeschouwer, C., Sbet, M. Color Channel Transfer for Image Dehazing, IEEE SIGNAL PROCESSING LETTERS, Volume: 26, Issue: 10, Pages: 1413-1417, ISSN: 1070-9908, eISSN: 1558-2361, 2019;
16. Avram, S., Udrea, A.M., Negrea, A., Ciopec, M., Duteanu, N., Postolache, C., Duda-Seiman, C., Duda-Seiman, D., Shaposhnikov, S. Prevention of Deficit in Neuropsychiatric Disorders through Monitoring of Arsenic and Its Derivatives as Well as Through Bioinformatics and Cheminformatics, INTERNATIONAL JOURNAL OF MOLECULAR SCIENCES, Volume: 20, Issue: 8, Article Number: 1804, PubMed ID: 31013686, eISSN: 1422-0067, 2019;
17. Baniias, O. Test case selection-prioritization approach based on memoization dynamic programming algorithm, INFORMATION AND SOFTWARE TECHNOLOGY, Volume: 115, Pages: 119-130, ISSN: 0950-5849, eISSN: 1873-6025, 2019;
18. Belega, D., Petri, D. Influence of the noise on DFT-based sine-wave frequency and amplitude estimators, MEASUREMENT, Volume: 137, Pages: 527-534, ISSN: 0263-2241, eISSN: 1873-412X, 2019;
19. Berei, E., Stefanescu, O., Muntean, C., Taranu, B., Stefanescu, M. Study on the formation of CoCr204/SiO2 nanocomposite obtained from Co(II) carboxylate and ammonium dichromate, JOURNAL OF THERMAL ANALYSIS AND CALORIMETRY, Volume: 138, Issue: 3, Pages: 1863-1870, ISSN: 1388-6150, eISSN: 1588-2926, 2019;
20. Binzar, T., Burdak, Z., Lazureanu, C., Popovici, D., Slocinski, M. Wold-Slocinski decompositions for commuting isometric triples, JOURNAL OF MATHEMATICAL ANALYSIS AND APPLICATIONS, Volume: 472, Issue: 2, Pages: 1660-1677, ISSN: 0022-247X, eISSN: 1096-0813, 2019;
21. Binzar, T., Pater, F., Nadaban, S. A Study of Boundedness in Fuzzy Normed Linear Spaces, SYMMETRY-BASEL, Volume: 11, Issue: 7, Article Number: 923, eISSN: 2073-8994, 2019;
22. Blaga, R., Sabadus, A., Stefu, N., Dughir, C., Paulescu, M., Badescu, V. A current perspective on the accuracy of incoming solar energy forecasting, PROGRESS IN ENERGY AND COMBUSTION SCIENCE, Volume: 70, Pages: 119-144, ISSN: 0360-1285, eISSN: 1873-216X, 2019;
23. Boncalo, O., Kolumban-Antal, G., Amaricai, A., Savin, V., Declercq, D. Layered LDPC Decoders With Efficient Memory Access Scheduling and Mapping and Built-In Support for Pipeline Hazards Mitigation, IEEE TRANSACTIONS ON CIRCUITS AND SYSTEMS I-REGULAR PAPERS, Volume: 66, Issue: 4, Pages: 1643-1656, ISSN: 1549-8328, eISSN: 1558-0806, 2019;
24. Buse, C., O'Regan, D., Saierli, O. Hyers-Ulam Stability for Linear Differences with Time Dependent and Periodic Coefficients: The Case When the Monodromy Matrix Has Simple Eigenvalues, SYMMETRY-BASEL, Volume: 11, Issue: 3, Article Number: 339, ISSN: 2073-8994, 2019;
25. Buse, C., O'Regan, D., Saierli, O. Hyers-Ulam Stability for Linear Differences with Time Dependent and Periodic Coefficients, SYMMETRY-BASEL, Volume: 11, Issue: 4, Article Number: 512, eISSN: 2073-8994, 2019;
26. Capota, E.A., Stangaciu, C.S., Micea, M.V., Curiac, D.I. Towards mixed criticality task scheduling in cyber physical systems: Challenges and perspectives, JOURNAL OF SYSTEMS AND SOFTWARE, Volume: 156, Pages: 204-216, ISSN: 0164-1212, eISSN: 1873-1228, 2019;
27. Caruntu, B., Bota, C., Lapadat, M., Pasca, M.S. Polynomial Least Squares Method for Fractional Lane-Emden Equations, SYMMETRY-BASEL, Volume: 11, Issue: 4, Article Number: 479, eISSN: 2073-8994, 2019;
28. Cocheci, L., Lupa, L., Lazau, R., Voda, R., Pode, R. Zinc recovery from waste zinc ash - A new "green" route for the preparation of Zn-Al layered double hydroxide used for molybdate retention, JOURNAL OF ALLOYS AND COMPOUNDS, Volume: 787, Pages: 332-343, ISSN: 0925-8388, eISSN: 1873-4669, 2019;
29. Dolha, S., Negirla, P., Alexa, F., Silea, I. Considerations about the Signal Level Measurement in Wireless Sensor Networks for Node Position Estimation, SENSORS, Volume: 19, Issue: 19, Article Number: 4179, PubMed ID: 31561569, eISSN: 1424-8220, 2019;

No.

UEFISCDI Awards

30. Dumitru, R., Ianculescu, A., Pacurariu, C., Lupa, L., Pop, A., Vasile, B., Surdu, A., Manea, F. BiFeO₃-synthesis, characterization and its photocatalytic activity towards doxorubicin degradation from water, CERAMICS INTERNATIONAL, Volume: 45, Issue: 2, Special Issue: SI, Pages: 2789-2802, ISSN: 0272-8842, eISSN: 1873-3956, 2019;
31. Gheju, M., Balcu, I. Sustaining the efficiency of the Fe(0)/H₂O system for Cr(VI) removal by MnO₂ amendment, CHEMOSPHERE, Volume: 214, Pages: 389-398, PubMed ID: 30268895, ISSN: 0045-6535, eISSN: 1879-1298, 2019;
32. Groza, B., Murvay, P.S. Efficient Intrusion Detection With Bloom Filtering in Controller Area Networks, IEEE TRANSACTIONS ON INFORMATION FORENSICS AND SECURITY, Volume: 14, Issue: 4, Pages: 1037-1051, ISSN: 1556-6013, eISSN: 1556-6021, 2019;
33. Groza, B., Popa, L., Murvay, P.S. TRICKS-Time TRIGGERed Covert Key Sharing for Controller Area Networks, IEEE ACCESS, Volume: 7, Pages: 104294-104307, ISSN: 2169-3536, 2019;
34. Hadaruga, N.G., Bandur, G.N., David, I., Hadaruga, D.I. A review on thermal analyses of cyclodextrins and cyclodextrin complexes, ENVIRONMENTAL CHEMISTRY LETTERS, Volume: 17, Issue: 1, Pages: 349-373, ISSN: 1610-3653, eISSN: 1610-3661, 2019;
35. Halbac-Cotoara-Zamfir, R., Keesstra, S., Kalantari, Z. The impact of political, socio-economic and cultural factors on implementing environment friendly techniques for sustainable land management and climate change mitigation in Romania, SCIENCE OF THE TOTAL ENVIRONMENT, Volume: 654, Pages: 418-429, PubMed ID: 30447580, ISSN: 0048-9697, eISSN: 1879-1026, 2019;
36. Ianas, C., Piciorus, M., Nicola, R., Ciopec, M., Negrea, A., Niznansky, D., Len, A., Almasy, L., Putz, A.M. Removal of cadmium from aqueous solutions using inorganic porous nanocomposites, KOREAN JOURNAL OF CHEMICAL ENGINEERING, Volume: 36, Issue: 5, Pages: 688-700, ISSN: 0256-1115, eISSN: 1975-7220, 2019;
37. Kang, S.H., Tiwari, A.K., Albulescu, C.T., Yoon, S.M. Time-frequency co-movements between the largest nonferrous metal futures markets, RESOURCES POLICY, Volume: 61, Pages: 393-398, ISSN: 0301-4207, eISSN: 1873-7641, 2019;
38. Lemle, L.D. On the L-infinity-Uniqueness of Dynamical Systems with Small Random Perturbation, RESULTS IN MATHEMATICS, Volume: 74, Issue: 1, Article Number: UNSP 26, ISSN: 1422-6383, eISSN: 1420-9012, 2019;
39. Linul, E., Lell, D., Movahedi, N., Codrean, C., Fiedler, T. Compressive properties of zinc syntactic foams at elevated temperatures, COMPOSITES PART B-ENGINEERING, Volume: 167, Pages: 122-134, ISSN: 1359-8368, eISSN: 1879-1069, 2019;
40. Linul, E., Marsavina, L., Linul, P.A., Kovacic, J. Cryogenic and high temperature compressive properties of Metal Foam Matrix Composites, COMPOSITE STRUCTURES, Volume: 209, Pages: 490-498, ISSN: 0263-8223, eISSN: 1879-1085, 2019;
41. Marsavina, L., Iacoviello, F., Pirvulescu, L.D., Di Cocco, V., Rusu, L. Engineering prediction of fatigue strength for AM50 magnesium alloys, INTERNATIONAL JOURNAL OF FATIGUE, Volume: 127, Pages: 10-15, ISSN: 0142-1123, eISSN: 1879-3452, 2019;
42. Matekovits, L., de Sabata, A., Silaghi, A.M. Frequency Selective Surface With Two Quasi-Independent Notch Frequencies, IEEE ACCESS, Volume: 7, Pages: 77261-77267, ISSN: 2169-3536, 2019;
43. Mihailescu, M., Negrea, A., Ciopec, M., Davidescu, C.M., Negrea, P., Duteanu, N., Rusu, G. Gold (III) adsorption from dilute waste solutions onto Amberlite XAD7 resin modified with L-glutamic acid, SCIENTIFIC REPORTS, Volume: 9, Article Number: 8757, PubMed ID: 31217435, ISSN: 2045-2322, 2019;
44. Minzatu, V., Davidescu, C.M., Negrea, P., Ciopec, M., Muntean, C., Hulka, I., Paul, C., Negrea, A., Duteanu, N. Synthesis, Characterization and Adsorptive Performances of a Composite Material Based on Carbon and Iron Oxide Particles, INTERNATIONAL JOURNAL OF MOLECULAR SCIENCES, Volume: 20, Issue: 7, Article Number: 1609, PubMed ID: 30935127, ISSN: 1422-0067, 2019;
45. Mitelea, I., Bena, T., Bordeasu, I., Utu, I.D., Craciunescu, C.M. Enhancement of Cavitation Erosion Resistance of Cast Iron with TIG Remelted Surface, METALLURGICAL AND MATERIALS TRANSACTIONS A-PHYSICAL METALLURGY AND MATERIALS SCIENCE, Volume: 50A, Issue: 8, Pages: 3767-3775, ISSN: 1073-5623, eISSN: 1543-1940, 2019;

No.

UEFISCDI Awards

46. Moaca, E.A., Mihali, C.V., Macaso, I.G., Racoviceanu, R., Soica, C., Dehelean, C.A., Pacurariu, C., Florescu, S. Fe₃O₄@C Matrix with Tailorable Adsorption Capacities for Paracetamol and Acetylsalicylic Acid: Synthesis, Characterization, and Kinetic Modeling, *MOLECULES*, Volume: 24, Issue: 9, PubMed ID: 31058855, eISSN: 1420-3049, 2019;
47. Mosoiu, C., Vlase, D., Vlase, G., Lazau, R., Vlase, T. TG-DTA and FTIR analyses of roman and later historic mortars from Drobeta-Turnu Severin region, *JOURNAL OF THERMAL ANALYSIS AND CALORIMETRY*, Volume: 138, Issue: 3, Pages: 2159-2166, ISSN: 1388-6150, eISSN: 1588-2926, 2019;
48. Nichita, I., Lupa, L., Stoia, M., Dragan, E.S., Popa, A. Aminophosphonic groups grafted onto the structure of macroporous styrene-divinylbenzene copolymer: preparation and studies on the antimicrobial effect, *POLYMER BULLETIN*, Volume: 76, Issue: 9, Pages: 4539-4557, ISSN: 0170-0839, eISSN: 1436-2449, 2019;
49. Nicolae, A., Korodi, A., Silea, I. Identifying Data Dependencies as First Step to Obtain a Proactive Historian: Test Scenario in the Water Industry 4.0, *WATER*, Volume: 11, Issue: 6, ISSN: 2073-4441, 2019;
50. Pana, A.M., Gherman, V., Sfirloaga, P., Rusu, G., Bandur, G., Popa, M., Rusnac, L.M., Dumitrel, G.A. Biodegradation studies on new glycopolymers derived from oligomeric D-mannose itaconates and 2-hydroxypropyl acrylate, *POLYMER DEGRADATION AND STABILITY*, Volume: 167, Pages: 210-216, ISSN: 0141-3910, eISSN: 1873-2321, 2019;
51. Patrinoiu, G., Dumitru, R., Culita, D.C., Munteanu, C., Birjega, R., Calderon-Moreno, J.M., Cucos, A., Pelinescu, D., Chifiriuc, M.C., Bleotu, C., Carp, O. Self-assembled zinc oxide hierarchical structures with enhanced antibacterial properties from stacked chain-like zinc oxalate compounds, *JOURNAL OF COLLOID AND INTERFACE SCIENCE*, Volume: 552, Pages: 258-270, PubMed ID: 31129297, ISSN: 0021-9797, eISSN: 1095-7103, 2019;
52. Pausescu, I., Todea, A., Badea, V., Peter, F., Medeleanu, M., Ledeti, I., Vlase, G., Vlase, T. Optical and thermal properties of intelligent pH indicator films based on chitosan/PVA and a new xanthylum dye, *JOURNAL OF THERMAL ANALYSIS AND CALORIMETRY*, ISSN: 1388-6150, eISSN: 1588-2926, 2019;
53. Radac, M.B., Precup, R.E. Data-Driven Model-Free Tracking Reinforcement Learning Control with VRFT-based Adaptive Actor-Critic, *APPLIED SCIENCES-BASEL*, Volume: 9, Issue: 9, Article Number: 1807, eISSN: 2076-3417, 2019;
54. Rajak, D.K., Mahajan, N.N., Linul, E. Crashworthiness performance and microstructural characteristics of foam-filled thin-walled tubes under diverse strain rate, *JOURNAL OF ALLOYS AND COMPOUNDS*, Volume: 775, Pages: 675-689, ISSN: 0925-8388, eISSN: 1873-4669, 2019;
55. Rajak, D.K., Pagar, D.D., Menezes, P.L., Linul, E. Fiber-Reinforced Polymer Composites: Manufacturing, Properties, and Applications, *POLYMERS*, Volume: 11, Issue: 10, Article Number: 1667, PubMed ID: 31614875, eISSN: 2073-4360, 2019;
56. Reisz, E., Tekle-Roettering, A., Naumov, S., Schmidt, W., Schmidt, T.C. Reaction of 1-propanol with Ozone in Aqueous Media, *INTERNATIONAL JOURNAL OF MOLECULAR SCIENCES*, Volume: 20, Issue: 17, PubMed ID: 31454911, eISSN: 1422-0067, 2019;
57. Sarbu, I., Dorca, A. Review on heat transfer analysis in thermal energy storage using latent heat storage systems and phase change materials, *INTERNATIONAL JOURNAL OF ENERGY RESEARCH*, Volume: 43, Issue: 1, Pages: 29-64, ISSN: 0363-907X, eISSN: 1099-114X, 2019;
58. Seclaman, E., Balacescu, L., Balacescu, O., Bejinar, C., Udrescu, M., Marian, C., Sirbu, I.O., Anghel, A. MicroRNAs mediate liver transcriptome changes upon soy diet intervention in mice, *JOURNAL OF CELLULAR AND MOLECULAR MEDICINE*, Volume: 23, Issue: 3, Pages: 2263-2267, PubMed ID: 30618122, eISSN: 1582-4934, 2019;
59. Stavi, I., Gusarov, Y., Halbac-Cotoara-Zamfir, R. Collapse and failure of ancient agricultural stone terraces: On-site geomorphic processes, pedogenic mechanisms, and soil quality, *GEODERMA*, Volume: 344, Pages: 144-152, ISSN: 0016-7061, eISSN: 1872-6259, 2019;
60. Stefanescu, M., Muntean, C., Berei, E., Vlase, T., Stefanescu, O. Preparation and characterization of CuCr₂O₄/SiO₂ and Cu₂Cr₂O₄/SiO₂ nanocomposites obtained from carboxylate complex combinations, *JOURNAL OF THERMAL ANALYSIS AND CALORIMETRY*, Volume: 138, Issue: 3, Pages: 1887-1894, ISSN: 1388-6150, eISSN: 1588-2926, 2019;

No.

UEFISCDI Awards

61. Stoia, D.I., Linul, E., Marsavina, L. Influence of Manufacturing Parameters on Mechanical Properties of Porous Materials by Selective Laser Sintering, *MATERIALS*, Volume: 12, Issue: 6, Article Number: 871, PubMed ID: 30875894, ISSN: 1996-1944, 2019;
62. Stoia, M., Pacurariu, C., Mihali, C., Malaescu, I., Marin, C.N., Capraru, A. Manganese ferrite-polyaniline hybrid materials: Electrical and magnetic properties, *CERAMICS INTERNATIONAL*, Volume: 45, Issue: 2, Special Issue: SI, Pages: 2725-2735, ISSN: 0272-8842, eISSN: 1873-3956, 2019;
63. Taucean, I.M., Tamasila, M., Ivascu, L., Miclea, S., Negrut, M. Integrating Sustainability and Lean: SLIM Method and Enterprise Game Proposed, *SUSTAINABILITY*, Volume: 11, Issue: 7, Article Number: 2103, ISSN: 2071-1050, 2019;
64. Tidrea, A., Korodi, A., Silea, I. Cryptographic Considerations for Automation and SCADA Systems Using Trusted Platform Modules, *SENSORS*, Volume: 19, Issue: 19, Article Number: 4191, PubMed ID: 31569636, eISSN: 1424-8220, 2019;
65. Todea, A., Bitcan, I., Aparaschivei, D., Pausescu, I., Badea, V., Peter, F., Gherman, V.D., Rusu, G., Nagy, L., Keki, S. Biodegradable Oligoesters of epsilon-Caprolactone and 5-Hydroxymethyl-2-Furancarboxylic Acid Synthesized by Immobilized Lipases, *POLYMERS*, Volume: 11, Issue: 9, Article Number: 1402, PubMed ID: 31455024, eISSN: 2073-4360, 2019;
66. Vasilescu, C., Todea, A., Nan, A., Circu, M., Turcu, R., Benea, I.C., Peter, F. Enzymatic synthesis of short-chain flavor esters from natural sources using tailored magnetic biocatalysts, *FOOD CHEMISTRY*, Volume: 296, Pages: 1-8, PubMed ID: 31202292, ISSN: 0308-8146, eISSN: 1873-7072, 2019;
67. Vintila, T., Ionel, I., Fregue, T.T.R., Wachter, A.R., Julean, C., Gabche, A.S. Residual Biomass from Food Processing Industry in Cameroon as Feedstock for Second-generation Biofuels, *BIORESOURCES*, Volume: 14, Issue: 2, Pages: 3731-3745, ISSN: 1930-2126, 2019;
68. Vlase, D., Rogozea, O., Mosoiu, C., Vlase, G., Lazau, R., Vlase, T. Thermoanalytical investigations of some ceramics dated from the Neolithic period, discovered at Oxenbrickel, Sanandrei, Romania, *JOURNAL OF THERMAL ANALYSIS AND CALORIMETRY*, Volume: 138, Issue: 3, Pages: 2145-2157, ISSN: 1388-6150, eISSN: 1588-2926, 2019;
69. Xiao, D., Heaney, C.E., Fang, F., Mottet, L., Hu, R., Bistrrian, D.A., Aristodemou, E., Navon, I.M., Pain, C.C. A domain decomposition non-intrusive reduced order model for turbulent flows, *COMPUTERS & FLUIDS*, Volume: 182, Pages: 15-27, ISSN: 0045-7930, eISSN: 1879-0747, 2019.

EXECUTIVE UNIT FOR FINANCING HIGHER EDUCATION, RESEARCH, DEVELOPMENT AND INNOVATION - UEFISCDI AWARDS - GRANTED PATENTS

1. Sîrbu N.A., Șerban V.A. Ultrasonic device for evaluation of the melt flow of polymeric and composites materials, OSIM, RO 130336 B1, 28.12.2018;
2. Muntean, S., Susan-Resiga, R.F., Bosioc, I.A., Constantin, S.R., Maxim, D.I., Tanasa, C., Vekas, L.N., Borbath, I., Anton, L.E. Equipment for reducing cavitational effects and leveling flow at turbo pumps inlet, OSIM, RO 131578 B1, 29.03.2019;
3. Iclanzan, T.A., Stan, D.V., Tulcan, A., Cosma, C., Dume, A.I., Tulcan, L.G. Mold and method for the injection of miniature parts, OSIM, RO 129443 B1, 28.06.2019;
4. Gontean, A.S., Cernaianu, M.O. Hybrid thermoelectric solar system, OSIM, RO 129477 B1, 28.06.2019;
5. Heput, T., Crisan, E., Ardelean, E., Socalici, A., Ardelean, M. Cylindrical multi-hollow briquette produced of ferrous pulverous waste, RO 127756 B1, 30.08.2019;
6. Susan-Resiga, R.F., Muntean, S., Tanasa, C., Bosioc, I.A., Ciocan, T., Popescu, C. Equipment for controlling instabilities of swirl flow from the conical diffuser of hydraulic turbines, OSIM, RO 131408 B1, 30.09.2019.

PROJECTS SUPPORTED BY PUBLIC FUNDS

National Research Projects

PROJECTS SUPPORTED BY NATIONAL PUBLIC FUNDS IMPLEMENTED BY UPT 2019

Fields	Total number of projects	Number of projects presented
Social and Economic sciences	2	1
Eco-Nano-Tehnologies and advanced materials	1	1
Energy, environment and climatic changes	5	5
Physics	1	-
Mathematics and Informatics	4	3
Health	1	-
Materials science	3	1
Earth Sciences	1	-
Engineering science	18	5
Information and Communication Technology, Space and Security	2	2
Total	38	18

EVOLUTION OF PROJECTS SUPPORTED BY NATIONAL PUBLIC FUNDS IMPLEMENTED BY UPT 2015 - 2019

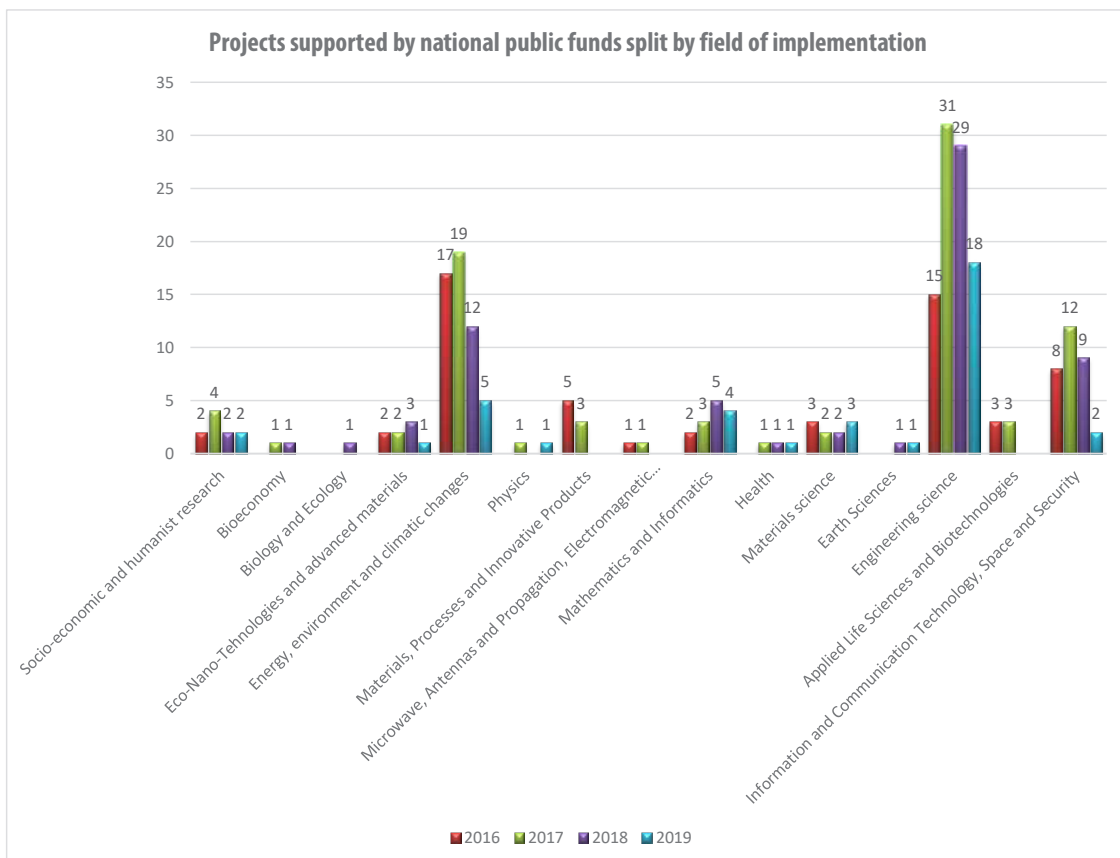
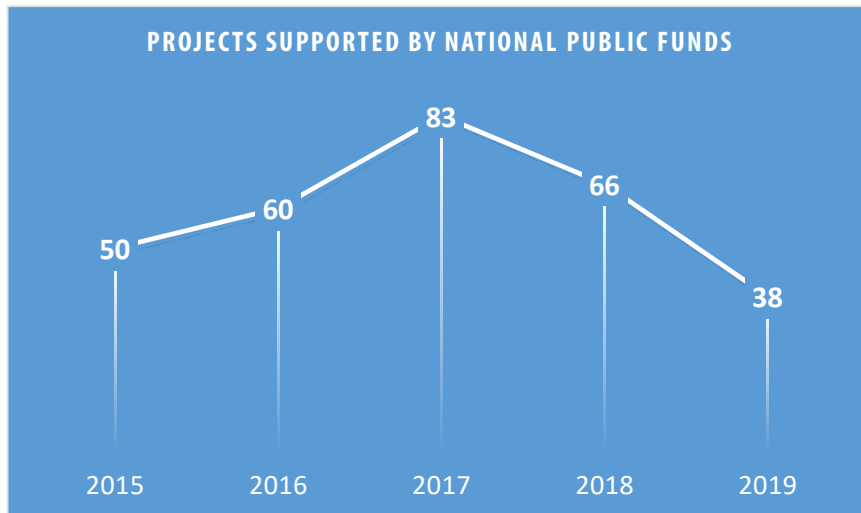

PRESENCE - PRIVACY-ENABLED, SECURED INTERACTIONS BETWEEN VEHICLES AND SMART ELECTRONIC DEVICES

Goal of the project:

The main target of the project is the design, analysis and implementation of security and privacy mechanisms for mediating access to in-vehicle functionalities by using intelligent mobile devices instead of classical RF and/or mechanical vehicle keys that are rigid and are lacking in terms of configurability and functionalities. The design of such security solutions is challenged by limitations on computational capabilities of existing components, e.g., in-vehicle controllers, as well as by the potential insecurity of smartphones.

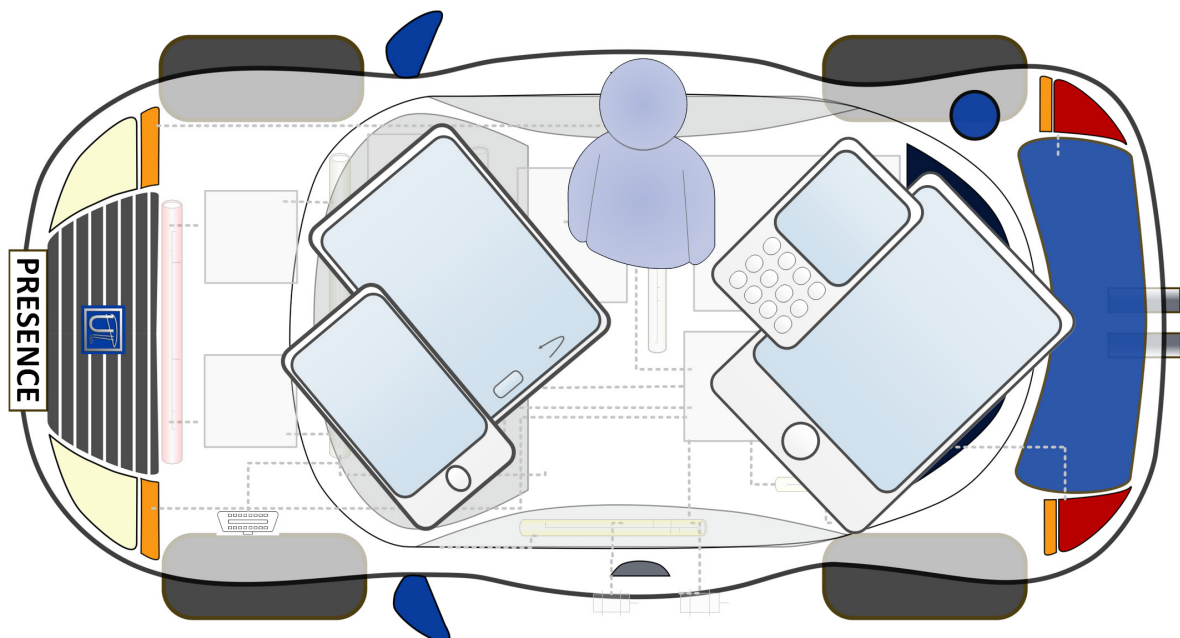

Short description of the project:

PRESENCE addresses the security of the newly emerged ecosystem of modern vehicles that interact with intelligent mobile devices, e.g., smart-phones.

Project implemented by

Politehnica University Timișoara

Implementation period:

2018-2020

Main activities:

Our project calls for the use of security enforcing technologies (e.g., NFC security cards) and modern device pairing techniques by harvesting environmental data (e.g., accelerometer data) to provide a secure and usable solution. Privacy enhancing technologies also need to be put in place in order to protect the users in front of corrupted cloud owners. As deployment platform we target Android, the mobile OS with the largest installed base. We also test the computational feasibility of the proposed solutions on a commonly employed controller for car BCMs. Main project objectives:

1. Design, analysis and implementation of security protocols.
2. Security enforcing technologies (e.g., NFC cards).
3. Ecosystem-based device association (e.g., accelerometer data).
4. Cloud-based access control.
5. Connectivity to in-vehicle control units.

Results:

We expect 5-10 research papers in relevant workshops and journals in the field addressing new concepts in vehicle access control supported by practical deployments on real-world components. PRESENCE is still in its first year of run, the publication list will be updated on the project website.

[1] Tudor Andreica, Bogdan Groza, Stefan Murvay, Applications of Pairing-Based Cryptography on Automotive-Grade Microcontrollers, 1st International Workshop on Safety, security, and pRivacy In automotiVe systEms (STRIVE 2018, SAFECOMP 2018 Workshops), Vasteras, Sweeden.

[2] Camil Jichici, Bogdan Groza, Stefan Murvay, Examining the Use of Neural Networks for Intrusion Detection in Controller Area Networks, 11th International Conference on Innovative Security Solutions for Information Technology and Communications, SecITC 2018, Bucharest, Romania, 2018

Applicability and transferability of the results:

Replacing traditional keys with smartphones appears like a natural step for achieving increased usability and an improved user experience. Industry application of the designed protocols and implemented functionalities for car access control by modern smartphones is immediate.

Financed through/by

CNCS-UEFISCDI PN-III-P1-1.1-TE-2016-1317, 2018-2020

Research Centre

Department of Automation and Applied Informatics

Research team

Prof. Bogdan GROZA, PhD
Assoc. Prof. Stefan MURVAY, PhD
Assist. Horatiu GURBAN, PhD
Eng. Tudor-Sebastian ANDREICA
Eng. Camil JICHICI

Contact information

Prof. Bogdan GROZA, PhD
Faculty of Automatics and Computers
Department of Automation and Applied Informatics
Address: Bd. V. Parvan nr. 2, Timisoara
Phone: (+40) 256 403 242
E-mail: bogdan.groza@aut.upt.ro
Web: <http://www.aut.upt.ro/~bgroza/projects/presence/index.html>

SECURITY ENHANCEMENTS AND VULNERABILITY ASSESSMENT FOR INDUSTRY-STANDARD NETWORKS (SEVEN)

Goal of the project

Most attacks on industry-standard networks rely on vulnerabilities. In this context, the SEVEN project aims to assess vulnerabilities in protocols not yet analyzed and to increase the security of industrial networks by proposing mechanisms to assure basic security objectives (e.g. authenticity, confidentiality or key management). The project also focuses on the design of intrusion detection systems. Finally, we also consider a performance impact evaluation of the introduction of the designed security solutions.

Short description of the project

Vulnerability evaluation and development of protection mechanisms for in industry-standard networks.

Project implemented by

PaI-Ștefan MURVAY (Project leader)
Bogdan GROZA (Mentor)

Implementation period

02/05/2018-30/04/2020

Main activities

The project is structured around three main activities.

1. The first main activity focuses on vulnerability assessment of industry-standard communication protocols. Our goal is to identify industry-standard communication-protocols that were not analyzed from a security perspective and identify potential vulnerabilities. Our first approach for enhancing the security of industry-standard communication protocols is the development of mechanisms for assuring basic security objectives such as: authenticity, confidentiality or key management.
2. A second approach focuses on designing intrusion detection mechanisms for the early identification of attack attempts.
3. Finally, we intend to provide an evaluation of the performance impact of the proposed mechanisms.

Results

The first phase of the SEVEN project focused on the identification of vulnerabilities in two industry-standard protocols, i.e., FlexRay and DeviceNet. The findings have been published as part of two conference papers:

[1] PaI-Ștefan Murvay, Bogdan Groza, Practical security exploits of the FlexRay in-vehicle communication protocol, presented at The 13th International Conference on Risks and Security of Internet and Systems (CRISIS 2018), 2018.

[2] PaI-Ștefan Murvay, Bogdan Groza, A brief look at the security of DeviceNet communication in industrial control systems, presented at The second Central European Cybersecurity Conference (CECC 2018), 2018.

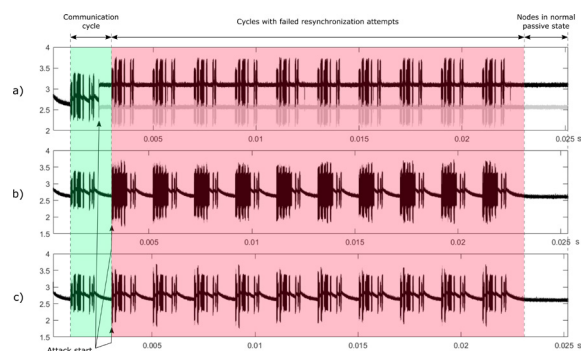

Figure 1. Three variants of the DoS attack for the entire communication.

We dedicated several lines of work to designing security mechanisms for enhancing the security of industry-standard protocols. The results obtained cover both secure communication mechanisms and intrusion detection systems for the Controller Area Network and FlexRay protocols. Papers presenting these results have been published in conference proceedings or journals:

[3] Pal-Stefan Murvay, Bogdan Groza, Accommodating Time-Triggered Authentication to FlexRay Demands, presented at The third Central European Cybersecurity Conference (CECC 2019), 2019.

[4] Camil Jichici, Bogdan Groza, Pal-Stefan Murvay, Integrating Adversary Models and Intrusion Detection Systems for In-Vehicle Networks in CANoe, presented at The 12th International Conference on Security for Information Technology and Communications (SECITC 2019), 2019.

[5] Pal-Stefan Murvay, Bogdan Groza, TIDAL-CAN: differential Timing based Intrusion Detection And Localization for Controller Area Network, accepted for publication in IEEE Access, 2020.

Applicability and transferability of the results

Our results add to the already known vulnerabilities of communication protocols used in industrial applications. Knowledge of the vulnerabilities is an important building block of designing proper security mechanisms for these communication protocols.

The proposed security mechanisms are efficient in preventing a series of spoofing and replay attacks as well as in the detection of attack attempts. These mechanisms focus on FlexRay, which was developed for the automotive industry and Controller Area Network, a communication protocol widely used both in the automotive domain and industrial control systems.

Financed through/by

This work was supported by a grant of the Romanian Ministry of Research and Innovation, CNCS - UEFISCDI, project number PN-III-P1-1.1-PD-2016-1198, within PNCDI III

Research Centre

Department of Automation and Applied Informatics

Research team

Assist. Prof. Stefan MURVAY, PhD
Prof. Bogdan GROZA, PhD

Contact information

Assoc. Prof. Pal-Ştefan MURVAY, PhD
Faculty of Automatics and Computers
Department of Automation and Applied Informatics
Address: Str. Vasile Pârvan, No. 2, Postal Code 300223, Timisoara
Phone: (+40) 256 403 242
E-mail: stefan.murvay@upt.ro
Web: <http://www.aut.upt.ro/~pal-stefan.murvay/>

NONLINEAR OBSERVERS-BASED CONTROL STRUCTURES APPLIED TO MECHATRONICS SYSTEMS

Goal of the project

The main objective of this project is to develop the necessary tools, modern control solutions and theoretical framework for later multi-purpose applications related to mechatronics systems.

The following objectives are defined:

01. Analysis, design and implementation of modern control solutions.
02. The validation of the proposed modeling and control approaches using simulations and experiments.
03. The dissemination of results.
04. Solving the project management issues.

Short description of the project

It is focused on the analysis, synthesis, modeling and development of modern control solutions.

Project implemented by

The construction of nonlinear observers still provides an open research field, efforts being made to broaden and adapt the proposed techniques in order to widen the classes of nonlinear systems to which they may apply.

Implementation period

10/10/2018 - 09/10/2020

Main activities

The main activities are as follows:

1. The elaboration of the synthesis on the operation and modelling of the proposed approaches.
2. The development and verification through simulation and experiments of the proposed control solutions for several classes of processes including those in mechatronics applications and laboratory control systems.
3. The development of Matlab / Simulink programs to test the proposed nonlinear observers.
4. The elaboration of comparative analyses to prove the validity of the approaches.

The potential impact to the scientific field may be significant because through new concepts and employed approaches, a new way for the use of highly advanced control designs in mechatronics applications is open.

Results

The targeted deliverables of this project are: 1 journal paper (e.g. IEEE Transactions on Industrial Informatics, IEE Transactions on Control Systems Technology, IET Control Theory & Applications, International Journal of General Systems, International Journal of Computers, Communications & Control, Acta Polytechnica Hungarica) and 3 conference papers published in the volumes of visible international conferences.

It is possible that more publications in this area of research will follow after the project has ended but it is very risky, due to the fact that the whole cycle of research - validation - writing manuscript - submission - revisions - acceptance lasts for at least 2 years for high quality publications.

Applicability and transferability of the results

The potential impact of the project in the scientific, social, economic or cultural environment is straightforward since the investigated topics can lead to automated tools for controller design and tuning. Although there is a wide range of possibilities for creating new themes for state-of-the-art research, noteworthy is also the impact in the socio-economic environment with directly applicative directions. In the project all mechatronics applications are focused on those applicable cost-effective training systems in the fields of robotics, automation and process control.

Financed through/by

The state budget / UEFISCDI

Research Centre

Politehnica University Timișoara (UPT)
Department of Automation and Applied Informatics

Research team

Assist. Prof. Alexandra-Iulia SZEDLAK-STÎNEAN, PhD
Prof. Radu-Emil PRECUP, PhD

Contact information

Assist. Prof. Alexandra-Iulia SZEDLAK-STÎNEAN, PhD
Faculty of Automatics and Computers
Department of Automation and Applied Informatics
Address: Bvd. Vasile Pârvan, Nr. 2, 300223, Timisoara
Phone: (+40) 256 403340
Mobile: 0040-735857668
E-mail: alexandra.szedlak-stinean@upt.ro
alexandra-iulia.stinean@aut.upt.ro
Web: <https://szedlak-stinean.wixsite.com/nobsmeccs>

IMPROVING THE PREDICTION OF OPINION DYNAMICS IN TEMPORAL SOCIAL NETWORKS: MATHEMATICAL MODELING AND SIMULATION FRAMEWORK

Goal of the project

Improving the prediction of opinion distribution in a target society by means of topological analysis, temporal and spatial distribution of opinion sources, and real-time simulation on empirically gathered data. As such, we define the following individual objectives:

- 1) Topological analysis of empirical social network data to understand how interconnection patterns of individuals and communities influence the spread of opinion.
- 2) Development of an innovative social interaction model, inspired by previous original work, considering the temporal aspect of opinion sources.
- 3) Definition of a strategy for real-time opinion seed selection by means of node and edge centrality distribution.
- 4) Synergy of results from objectives 1-3 with direct applicative socio-economic impact by developing a crowdsourcing web-platform for voting and gathering anonymized empirical data from citizens.

Short description of the project

In the wake of big data analytics, this project sets out to push the boundaries of scientific understanding of opinion dynamics in social networks by analyzing how the underlying network topology influences communication patterns and the polarization of opinion.

Project implemented by

Assist. Prof. Alexandru TOPÎRCEANU – responsible for outlining the research goals, modeling of experiments, simulation and data validation, writing scientific manuscripts, overall project management.

Prof. Radu-Emil PRECUP – mentor for the project director, research goals, experiment modeling, revising scientific manuscripts.

Denis Nuțiu (4th year student) – web platform implementation.

Implementation period

02.05.2018 – 30.11.2019 (19 months)

Main activities

This project comes to improve our understanding of opinion diffusion in emergent social networks. Consequently, to build models that are aware of these phenomena, we propose a topological analysis of empirical data using network motifs, community detection algorithms and statistics to understand the behavioral patterns and centralities which have an impact on the spatial and temporal distribution of opinion.

As opposed to most existing opinion interaction models, we propose a temporal opinion injection model which evolves over time according to basic human traits and underlying social topology. Below is a schematic exemplifying the two different approaches considered.

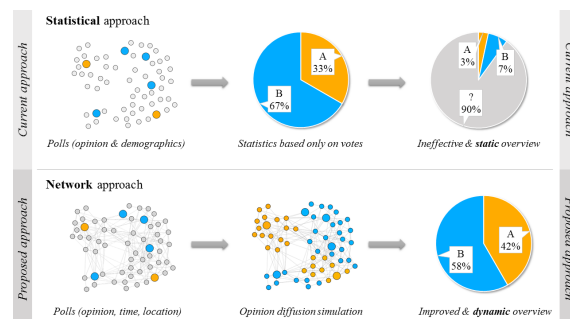

In the above figure we showcase the impact of the proposed project methodology in perspective to the current statistical approaches in opinion poll analysis and prediction. The statistical method relies solely on a small subset of individuals from which it tries to extrapolate overall opinion distribution; however, most of the opinion remains unknown (see gray pie chart in upper panel). Our proposed approach implies simulation of opinion propagation using more reliable scientific models and thus yields a more accurate perspective of opinion distribution (lower panel).

Results

We make use of temporal microscopic diffusion models to predict the macroscopic response of a target society being targeted by opinion injection. Our results pinpoint to the fact that time-awareness is more significant in poll prediction performance than previously considered.

Below, we exemplify a snapshot of the poll evolution calculated for the 2016 US presidential pre-election period. We provide snapshots of the final period before elections using cumulative counting (A), and our time-aware method (B) to estimate polls. Here, we exemplify the relative differences (Clinton–Trump) in polls at several time points.

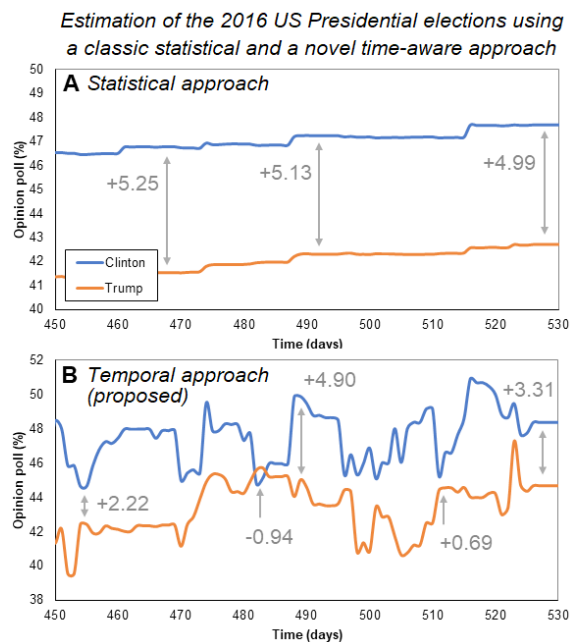

For the 2012 US elections we can approximate the final poll results within a 2% margin, while current approaches produce much greater offsets of about 7%. Similarly, for the 2016 elections, our method (TA) manages to come within 1.5% of the real election results, while the current statistical approach (SA) remains outside the 4% margin. In terms of quantifying the overall performance boost of our method, compared to the benchmark methods, TA proves to be 75% more accurate for the 2012 elections, respectively 74% for estimating the 2016 elections.

As an explanation to why our TA method has a superior prediction capability is that, by taking into consideration the timing of pre-election opinion injection, TA captures the momentum of candidate popularity.

Applicability and transferability of the results

Current state of the art solutions for prediction, employed by respectable institutions in the US, like the *Huffington Post*, *Real Clear Politics*, or *Five Thirty Eight*, employ poll counting and combining polls with economic indices. Nevertheless, we have not seen any time-aware method that is similar to the one proposed by us in this project.

Consequently, we consider the framework developed in this project as very encouraging, and possibly opening a new line of research to further perfect our initial proposed method, which, to the best of our knowledge, is original and new. We hope to pave a new path of research targeting dynamic and temporal social network analysis, with immediate applicability in real-world systems where the needs for predictability and control are paramount.

Financed through/by

Romanian National Authority for Scientific Research and Innovation (UEFISCDI), project number PN-III-P1-1.1-PD-2016-0193

Research centre

- CCCTI: Research Centre for Computers and Information Technology (UPT)
- ACSA: Advanced computing systems and architectures research group

Research team

Director – Assist. Prof. Alexandru TOPÎRCEANU, PhD

Mentor – Prof. Radu-Emil PRECUP, PhD

Contact information

Assist. Prof. Alexandru TOPÎRCEANU, PhD

Faculty of Automation and Computing

Department of Computer and Information Technology

Address: 2, Vasile Pârvan Bvd., 300223, Timișoara

Phone: +40 256 403261

E-mail: alex.topirceanu@cs.upt.ro

Web: <http://staff.cs.upt.ro/~alex/>

Project website: staff.cs.upt.ro/~alex/projects/impress/site/

COMPREHENSIVE MONITORING METHODOLOGY FOR AGRICULTURAL LAND USE DYNAMIC CHANGES USING MULTISOURCE REMOTE SENSING DATA – AGRITELD

Goal of the project

The scientific study of agricultural lands is found in the specialty literature since the 1930s. These studies gradually turn from traditional studies (field investigations, field studies and then laboratory) to 3s spatially-based technology. The Integrated Approach to 3s Technology represents trends in precision farming. In this respect, in Europe and beyond, the factors responsible for the rational and sustainable management of agricultural land (governments) gradually achieve the importance of “remote” monitoring of agricultural lands and the importance of studying them globally.

Short description of the project

Information acquisitioned by remote sensing facilitate rapid and effective quantification of changes or advances a plant or several plants have encountered, their development phases and the basis for a new perception of research into precision farming.

Research and agricultural land monitoring using the benefits of remote sensing has developed a lot in recent years, but there are still unresolved issues related to: remote monitoring of a wide range of species (high variety), high accuracy, quasi-reality is still at the operating stage etc.

Information acquisitioned by remote sensing facilitate rapid and effective quantification of changes or advances a plant or several plants have encountered, their development phases and the basis for a new perception of research into precision farming.

Research and agricultural land monitoring using the benefits of remote sensing has developed a lot in recent years, but there are still unresolved issues related to: remote monitoring of a wide range of species (high variety), high accuracy, quasi-reality is still at the operating stage etc.

Project implemented by

Beneficiary:

Politehnica University Timișoara

Department: Overland Communication Ways, Foundations and Cadastral Survey

Partner:

Chinese Academy of Science

Institute of Remote Sensing and Digital Earth

Implementation period

June 2018 – December 2019

Main activities

Through the cooperation, we wish to form a systematic method to monitor the agricultural land use quickly and accurately, build up the remote sensing model of agricultural land use change assessment, prediction and spatial optimization. This could support centralized and orderly management of agricultural land, which provides scientific basis for agricultural land.

As originality and innovation elements following objective can be specified:

1. Developing multi-source remote sensing data fusion technology, and increasing the accuracy of land field determinations;
2. Developing a comprehensive monitoring technology based on multi-source remote sensing analysis of dynamic change of agricultural land use;
3. Establishing and validating an assessment, prediction and spatial optimization model of agricultural land use change using GIS facilities (Vilceanu, Herban and Meng 2017);

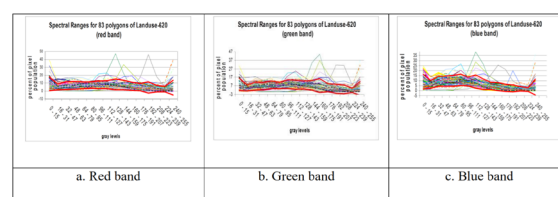

Fig. 1 GIS-Driven – Detectarea schimbărilor

There are several objectives standing before us. The cooperation in itself is a very positive goal as it opens each team to: other regions; different angles, view and facets of agricultural management; and different ways of thinking. More specifically, the cooperation proposed here between China and Romania is envisaged to help with introducing each other with the technology of monitoring and of land classification with high precision, as done at the other country.

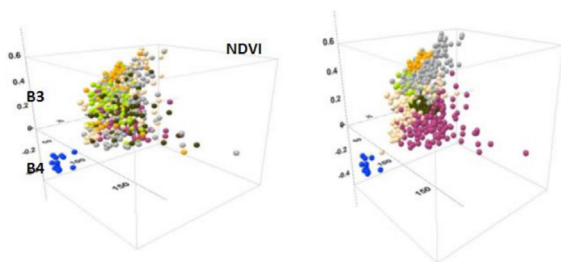

Fig. 2 IDA change detection and classification (left-before, right- after)

A secondary objective would be realizing better the usage of the spatial information embedded in the satellite images for the advancement of agricultural technology. The concept of GIS-Driven / GIS-support, mentioned above, is clearly one of the clear cut tools for such endeavour. In addition, both teams set some more specific goals:

- To learn the special characteristics of the satellite images provided by the Chinese cartographic satellite and any other products that will be provided for parallel processing.
- To establish the minimal resolution needed for the change detection and agricultural related classification at hand.
- To develop a modular concept of methodology that will support future adaptation to new satellite sources.

Results

- Developing a fusion technology of remote sensing data acquired from multiple sources;
- Developing a smart monitoring method based on dynamic changes of agricultural lands analysis from multiple sources of remote sensing;
- Establishing and validating an assessment, prediction and spatial optimization model of agricultural land use changes;
- Integrating spatial information in GIS platforms.

Applicability and transferability of the results

Applicability of the study its very various and useful for:

- Governments - implementing agricultural smart polities;
- small and large agricultural farms;
- another areas of research like forestry;
- etc..

Financed through/by

PN-III- Program: European and International Cooperation

Research Centre

Infrastructure for Construction and Transportation

Research team

Prof. Sorin HERBAN, PhD
 Prof. Carmen GRECEA, PhD
 Assist. Prof.. Beatrice VILCEANU, PhD
 Assist. Prof. Rares HALBAC, PhD
 Adrian ALIONESCU, PhD Student
 Anca MORARESCU, PhD Student

Contact information

Prof. Sorin HERBAN, PhD
 Faculty of Civil Engineering
 Department of Overland Communication Ways, Foundations and Cadastral Survey
 Address: str. Traian Lalescu, St, 2A, Timisoara
 E-mail: sorin.herban@upt.ro

ADVANCED MATERIALS BASED ON COMBUSTION-SYNTHESIZED MAGNETIC IRON OXIDES NANOPARTICLES AND THEIR CYTOTOXICITY DESIGNED FOR CANCER TREATMENT

Goal of the project:

- Obtaining of magnetic iron oxides nanoparticles using the combustion synthesis method and monitoring the influence of several working parameters: fuel type (EDTA, citric acid, glucose), oxidant/fuel molar ratio (fuel-rich compositions), ignition procedure (heating mantle, microwave field), working atmosphere (in air/no air), carbon and organic residues presence.
- Preparation of colloidal suspensions.
- The assessment of the toxicological profile/biological activity of the iron oxide colloidal suspensions on normal/tumour liver and kidney cell lines.

Short description of the project

The project presents the preparation of iron oxides with via combustion synthesis and testing their selective cytotoxicity.

Project implemented by

Department of Applied Chemistry and Engineering of Inorganic Compounds and Environment,
Faculty of Industrial Chemistry and Environmental Engineering,
Politehnica University Timișoara

Implementation period

July 2017–December 2019

Main activities

Combustion synthesis of magnetic iron oxides nanoparticles. The influence of several parameters on the powders characteristics were pursued:

- nature of the fuel: glucose, citric acid, EDTA, TWEEN 80, hexamethylenetetramine
- reaction conditions: presence and absence of air
- carbon and organic residues presence and chemical oxidation removal using H_2O_2

Characterization of magnetic iron oxides nanoparticles:

- combustion reactions evolution was assessed by TG–DSC thermal investigations
- the phase composition of the synthesized compounds was investigated by XRD
- specific surface area (BET)
- FTIR spectroscopy

The obtained results were centralized and interpreted for recipes optimization.

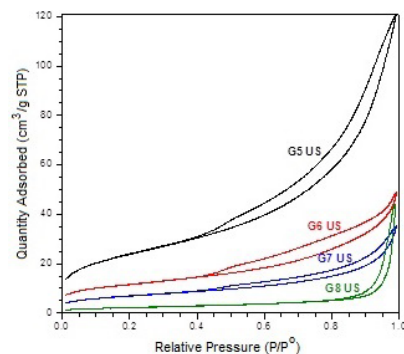
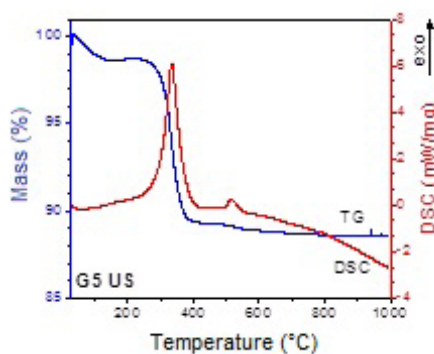
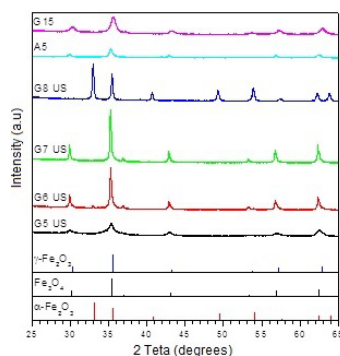

Results:

Synthesis protocols and recipes for 31 samples prepared by combustion synthesis. It was established the influence of different fuels (glucose, citric acid, EDTA, TWEEN 80, hexamethylenetetramine) and of the reaction conditions on the synthesis of iron oxides with magnetic properties.

Applicability and transferability of the results

These researches open an entirely new perspective on the potential use of combustion-synthesized iron oxide nanoparticles in cancer therapy by selective cytotoxicity.

The results will be subjected to a patent application.

Financed through/by

Ministry of Research and Innovation, CNCS - UEFISCDI, project number PN-III-P4-ID-PCE-2016-0765, within PNCDI III

Research Center

Research Centre for Inorganic Materials and Alternative Energies

Research team

1. Cornelia Pacurariu - project leader
2. Cristina Dehelean - experienced researcher
3. Robert Ianos - experienced researcher
4. Radu Lazau - experienced researcher
5. Dorina Coricovac - postdoc researcher
6. Alina Moaca - postdoc researcher
7. Roxana Babuta (Racoviceanu) - postdoc researcher
8. Eliza Muntean - PhD student
9. Aylin Capraru - PhD student

Contact information

Prof. Cornelia PĂCURARIU, PhD
Faculty of Industrial Chemistry and Environmental Engineering
Department of Applied Chemistry and Engineering of Inorganic Compounds and Environment
Address: Bd.V. Pîrvan, No.6 Postal Code 300223, Timisoara
Phone: (+40) 256 404 144
Mobile: +40 722 54 75 18
E-mail: cornelia.pacurariu@upt.ro
Web: <http://www.chim.upt.ro/ro/caicam>

INTEGRATED AND SUSTAINABLE PROCESSES FOR ENVIRONMENTAL CLEAN-UP, WASTEWATER REUSE AND WASTE VALORIZATION – SUSTENVPRO

Goal of the project

The goal of complex project SUSTENVPRO is to increase the institutional performance in the ENVIRONMENT field of a consortium of 5 public research organizations with recognized research performances and one R&D National Institute under consolidation, through an integrative approach which supports/develop the existent research competencies of each partner and transfer capacities of results with applicative and innovative potential envisaging the elimination of priority pollutants from water using innovative advanced water/ wastewater treatment processes and waste recovery.

Short description of the project

The complex project SUSTENVPRO consisted of 5 research component projects (PC):

PC 1. Complex evaluations of priority pollutants present in various water matrixes and risk identification on the ecosystems and human health;

PC 2. Water treatment processes optimization and development of innovative materials for the priority pollutants removal;

PC 3. Valorization of biomass resources for the development of innovative processes for wastewater treatment and priority pollutants removal;

PC 4. Metallic waste valorization for innovative wastewater treatment process development and removal of priority pollutants;

PC 5. Sustainability assessments of water/ wastewater treatment and waste valorization processes based on life cycle assessment.

Project implemented by

The project is implemented by 4 universities and two national R&D institutes:

Coordinator: "Gheorghe Asachi" Technical University of Iasi;

Partners: Politehnica University of Bucharest; "Alexandru Iona Cuza" University of Iasi; Politehnica University Timișoara; "Petru Poni" Institute of Macromolecular Chemistry Iasi; National Research and Development Institute for Environmental Protection, Bucharest.

Implementation period

2018 – 2020

Main activities

- Developing and validating an innovative approach oriented to analysis, preventing and correcting the environmental risks associated with the presence of priority pollutants in various matrices of water use;
- Development of efficient innovative water treatment and advanced wastewater treatment processes in order to eliminate priority organic and inorganic pollutants in the anthropic water cycle;
- Development of new innovative materials (polymeric or composite materials) with properties designed according to the characteristics of the priority pollutants;
- Utilization of materials from organic (biomass) and inorganic waste (metallic waste) in innovative wastewater treatment processes for removing priority pollutants and recirculating / reusing water;
- Sustainability assessment of processes and products through Life Cycle Assessment tool.

Results

- Research workplaces;
- New/significantly improved technologies /procedures;
- New/significantly improved research services;
- New research and technology consultancy services (uploaded on the ERRIS platform);
- Research services by sharing the research infrastructure among project partners (A1 and A2 research vouchers);
- Knowledge transfer to water operator through C voucher;
- Research papers published in ISI-ranked journals;
- Communications at national and international scientific events (conferences, exhibitions);
- Dissemination and technology transfer workshops;
- (Initiation /Intermediary /Final) Project workshops;
- RDI common program (in agreement with the institutional development plan of every partner).

Applicability and transferability of the results

- Transferability of research results between consortium partners;
- Technological transfer of advanced water/wastewater treatment technologies/procedures to public and private economic environment (regional water operators, environmental companies, private companies in the water/waste field etc.); knowledge transfer to regional water operator through C voucher within the project framework tested at pilot scale as treatability study for concrete applications in drinking water treatment;
- Good practice guide for circular economy in water field for sustainability consulting company, non-profit organization, environmental agencies.

Financed through/by

Executive Agency for Higher Education, Development and Innovation Funding (UEFISCDI)

Research centre

Research Centre in Environmental Science and Engineering

Research team

UPT Project Responsible: Prof.dr.eng. MANEA Florica
Scientific Researcher, level I : PODE Rodica
Scientific Researcher, level III: COCHECI Laura
Scientific Researcher, level III: POP Aniela
Scientific Researcher, level III: VODA Raluca
Scientific Researcher, level III: BACIU Anamaria
Development engineer: IGHIAN Lacrima-Crysty
Development engineer: DELCIOIU Claudia

Contact information

Prof. Florica MANEA, PhD
Faculty of Industrial Chemistry and Environmental Engineering
Department of Applied Chemistry and Engineering of Inorganic
Compounds and Environment
Address: Str.V. Parvan, No.6 300223, Timisoara
Phone: (+40) 256 403069
Mobile(+40)724506095
E-mail: florica.manea@upt.ro
Web: <http://sustenvpro.dimm.tuiasi.ro/>

ADVANCING RE-CENTRING ECCENTRICALLY BRACED FRAMES: NEW LINK TYPOLOGIES AND INFLUENCE OF REINFORCED CONCRETE SLAB (ARNIS)

Goal of the project

To reduce the costs and downtime of a structure hit by an earthquake, removable links and re-centering capacity concepts may be implemented in a dual eccentrically braced structure. The project aims at extending the validation of re-centering capability and link replacement feasibility on extended end-plate typologies and also investigate more detailed the global and local influence of three-dimensional reinforced concrete slab panels, as well as reinforced concrete slab repair.

Short description of the project

It studies the re-centering capability using new link typologies and the concrete slab influence.

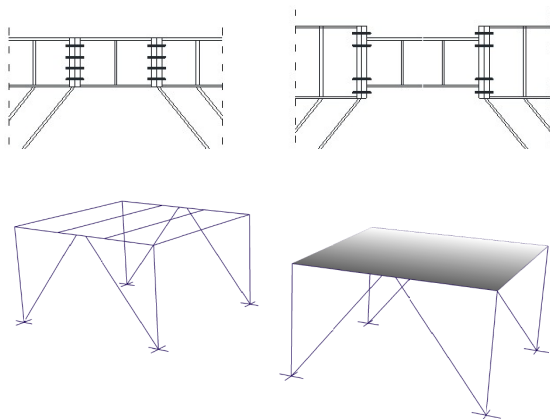

- Experimentally testing isolated links assemblies in two solutions: flush end-plate bolted link and extended end-plate bolted link, at natural scale (1:1), both of them with and without concrete slab above the link (8 tests) – proposed for 2019;
- Experimentally testing a 3D portal frame, with/without concrete, with damaged/repared slab (4 tests) – proposed for 2020;
- Calibrating numerical models post-test – proposed for 2019 and 2020;
- Seismic performance and behavior factors numerical assessment – proposed for 2020.

Results

In 2018 – prototype structures design, re-centering capability validation and link removal procedure description.

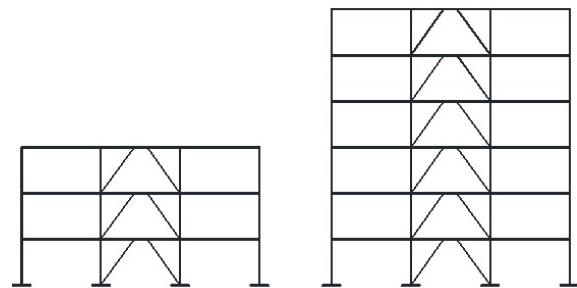

Project implemented by

Politehnica University Timișoara (UPT) – Civil Engineering Faculty – Steel Structures and Structural Mechanics Department

Implementation period

10.10.2018 – 09.10.2020

Main activities

- Designing prototype structures with two height levels: medium rise (P+2E) and higher rise (P+5E), with differently connected links (flush/extended end-plate), extending the bolted links removal procedure and re-centering capability – done in 2018;

Proposed for 2019 and 2020:

- Design of experimental specimens;
 - Material behavior curves;
 - Links experimental results – describe local behavior;
 - Frames experimental results – describe global behavior;
 - Calibrated numerical models for links;
 - Values of behavior factors for structures.
- Obtained results will be presented in project deliverables and scientific papers at international conferences/journals.

Applicability and transferability of the results

Increase the application potential of the system both at national and international levels: by improved connections (larger behavior factor obtained), improved knowledge on the effect of reinforced concrete slab and repair of the slab.

Solutions providing self-centering of the structure are technically demanded and require specialized knowledge, careful maintenance and high initial cost. Alternatively, a conventional design can be employed, but with the dissipative members realized to be removable allowing their replacement when damaged and reducing the repair costs.

Financed through/by

Executive Agency for Higher Education, Research, Development and Innovation Funding (UEFISCDI)

Research centre

Research Centre for Mechanics of Materials and Structural Safety - CEMSIG

Research team

Assist. Mirela Adriana CHESOAN, PhD (project manager)
Assoc. prof. Aurel STRATAN, PhD

Contact information

Assist. Mirela Adriana CHESOAN, PhD
Faculty of Civil Engineering
Department of Steel Structures and Structural Mechanics,
Ioan Curea Street No.1, 300224, Timișoara
Phone: +40 (0) 256 403 925
E-mail: adriana.chesoan@upt.ro
Web: https://www.ct.upt.ro/centre/cemsig/arnis_en.htm

DUAL STATOR WINDING INDUCTION GENERATOR SYSTEM FOR WIDE-VARIABLE SPEED WIND POWER APPLICATION (DSWIG)

Goal of the project:

For wind power plants, the cage-type induction generator (IG), as a competent option, has many advantages for wind power applications, such as innate brushless construction, low maintenance demand, good overload protection ability, and so on. The most significant advantages of this machine lie in its ability to output good performance electric power at variable rotor speeds. To adapt the wide variation of wind speed and capture much more wind energy, the wind power system should have the variable-speed operation ability in a wide speed range.

Short description of the project:

The subject of the bilateral project, which relates to a wind power system with a dual stator-winding induction generator.

Project implemented by

Politehnica University Timisoara (UPT) - România
Nanjing University of Aeronautics and Astronautics (NUAA) - China

Implementation period:

02.07.2018-31.12.2019

Main activities:

The basic priority of the collaboration is the development of a scientific project for participation in competitions announced by Horizon 2020 and other international programs. The work plan proposed is based on regular meetings of the members of both teams alternately in Romania and China; a) a first visit will be in China, by a team from Romania. On this occasion the Romanian members will meet all the team members from China, will visit research labs; b) the next meeting will take place in Romania, at Timișoara at the Faculty of Electrical and Power Engineering, at the Romanian Academy Branch Timișoara and at the Hunedoara Engineering Faculty. On this occasion contact will be established with all members of the project team from Romania, visits will be carried out to the research laboratories of the two faculties, and there will be group discussions between members of both teams according to scientific areas of joint research.

Results:

The results for the Year 2018 are:

Between July 2 and December 31, 2018, was carried out on the topic of DSWIG Generator Design. At this stage, the Romanian team carried out the following activities: dimensioning of the experimental model, analytical design, optimal design, finite element validation, design of the electric drive system and the experimental test bench. Between August 26 and 30, 2018, a team (Deaconu Sorin Ioan, Topor Marcel and Hulea Dan Cornel) from the Politehnica University Timisoara (UPT), made a trip to Budapest where he attended the IEEE International Conference on Power Electronics and Motion Control (PEMC), where they met a team from the Nanjing University of Aeronautics and Astronautics, China, led by BU Feifei, project director from the Chinese team.



Applicability and transferability of the results:

The results obtained through this project are of interest to the industry of the construction of electrical machinery, renewable energy converters, wind systems, hydro systems, and producers of autonomous generators for vehicles, boats, river and sea vessels, and aircrafts. Based on the project developed by the team in Romania, the Chinese team will realize the experimental model and its control system. Following experimental testing, parameters and features will be obtained, and based on them, a Chinese producer will be identified to introduce these systems into production.

Financed through/by

Executive Agency for Higher Education Research, Development and Innovation Funding (UEFISCDI)

Research Center

Intelligent Control of Energy Conversion and Storage

Research team

The research team of UPT consists in coordinator, Associate professor Sorin Ioan DEACONU, PhD teachers (PhD's):

Ion BOLDEA,
Nicolae MUNTEAN,
Lucian Nicolae TUTELEA,
Marcel TOPOR,
Ana-Adela MOLDOVAN-POPA,
and engineers and PhD students:
Liviu-Dănuț VITAN,
Adrian Daniel MARTIN and
Dan HULEA.

Contact information

Assoc. Prof. Sorin Ioan DEACONU, PhD
Faculty of Hunedoara Engineering
Department of Electrical Engineering and Industrial Informatics
Address: Revoluției Str., No.5, Postal Code 331128, Hunedoara
Phone: (+40) 254 207 529
Mobile: (+40) 744 544 846
E-mail: sorin.deaconu@fih.upt.ro
Web: <http://www.fih.upt.ro/dswig/>

THE RELATIONSHIP BETWEEN ENERGY INVESTMENTS, SHOCKS IN ENERGY PRICES AND THE MACROECONOMY IN THE EU COUNTRIES (EIP-MACRO)

Goal of the project:

Energy prices record high fluctuations increasing market uncertainty. The central role of oil prices in influencing consumption, investments and macroeconomic policies requires special attention. In this context, the main goals of the project are: (i) to analyse the investment behaviour and TFP of energy sector companies using firm-level data; (ii) to investigate the non-linear interactions between oil prices and the macroeconomy; (iii) to assess the environmental impact of energy policies, EU regulations and renewable energy consumption.

Short description of the project:

The project aims to provide a deeper understanding of the energy and environmental economics issues, analyzing the interactions between energy prices and the macroeconomy.

Project implemented by

Politehnica University Timișoara

Implementation period:

02.05.2018 – 30.04.2020

Main activities:

- a) Development of research on three directions:
 - determinants of investments and TFP of energy companies
 - macroeconomic impact of oil price shocks
 - environmental impact of energy policies.
- b) Econometric analyses and generation of results
- c) Dissemination of results in conferences and high-ranked journals.

Results:

a) 3 Research stages for young researchers

- University of Poitiers, University of Augsburg, International School for Social and Business Studies

b) 11 Conference participations

c) 1 organized research workshop

d) 10 ISI journal papers:

1. Grecu, E., Aceleanu, M.I. and Albulescu, C.T. (2018). The economic, social and environmental impact of shale gas exploitation in Romania: A cost-benefit analysis, *Renewable and Sustainable Energy Reviews*, 93, 691-700. (Q1)
2. Albulescu, C.T. and Pépin, D. (2018). Monetary integration, money demand stability and the role of monetary overhang in forecasting inflation in CEE countries, *Journal of Economic Integration*, 33(4), 841-879 (EMCI).

3. Albulescu, C.T., Kang, S.H., Tiwari, A.K. and Yoon, S-M. (2019). FDI, income, and environmental pollution in Latin America: Replication and extension using panel quantiles regression analysis, *Energy Economics*, 84, Article 104504. (Q1).

4. Kang, S.H., Tiwari, A.K., Albulescu, C.T. and Yoon, S-M. (2019). Exploring the time-frequency connectedness and network among crude oil and agriculture commodities V1, *Energy Economics*, 84, Article 104543. (Q1).

5. Albulescu, C.T., Riza, D., Raheem, I.D. and Tiwari, A.K. (2019). Does economic policy uncertainty connect financial markets? Evidence from oil and commodity currencies, *Energy Economics*, 83, 375-388. (Q1).

6. Tiwari, A.K., Adewuyi, A.O., Albulescu, C.T. and Wohar, M.E. (2020). Empirical evidence of extreme dependence and contagion risk between main cryptocurrencies, *The North American Journal of Economics and Finance*, 51, 101083. (Q3).

7. Grecu, E., Albulescu, C.T., Pârțachi, I.P., Stancu, S. and Trașcă, D.L. (2020). Output, uncertainty and fuel prices in the EU countries, *Economic Computation and Economic Cybernetics Studies and Research*, 1, 15-30. (Q3).

8. Albulescu, C.T., Artene, A.E., Luminosu, C.T. and Tamasila, M. (2019). CO2 emissions, renewable energy production and environmental regulation in the EU countries, *Environmental Science and Pollution Research*, <https://doi.org/10.1007/s11356-019-06155-1> (Q2).

9. Albulescu, C.T., Bouri, E., Roubaud, D. and Tiwari A.K. (2020). Quantile causality between banking, stock and real estate securities returns in the US, *The Quarterly Review of Economics and Finance*, <https://doi.org/10.1016/j.qref.2020.03.005> (Q3)

10. Albulescu, C.T., Tiwari, A.K., Ji, Q. (2020). Copula-based local dependence between energy, agriculture and metal commodity markets, *Energy*, <https://doi.org/10.1016/j.energy.2020.117762> (Q1).

Applicability and transferability of the results:

The results of the project have both a micro- and a macro-level applicability. In the first case, the strategic management of companies activating in the energy field will benefit from a deeper understanding of elements influencing the level of investment in the industry. In the second case, national and international regulators and policy makers receive information about the impact of shocks in energy prices on inflation and exchange rate, but also about the effectiveness of environmental regulation and the role of renewable sources in reducing CO2 emissions at EU level.

Financed through/by

Executive Unit for Financing Higher Education, Research, Development and Innovation - UEFISCDI

Research Center

Research Center in Engineering and Management

Research team

Prof. Claudiu ALBULESCU, PhD (Principal Investigator)
Assoc. Prof. Alin ARTENE, PhD
Assoc. Prof. Caius LUMINOSU, PhD
Assist. Prof. Șerban MICLEA, PhD
Maria BOATCĂ-BARABAȘ, PhD student
Roxana SÎRBU, PhD student

Contact information

Prof. Claudiu ALBULESCU, PhD
Faculty of Management in Production and Transportation,
Department of Management
Address: Remus Street, no. 14, 300191, Timișoara
Phone: (+40) 256 404 035
Mobile: (+40) 743 089 759
E-mail: claudiu.albulescu@upt.ro
Web: <https://sites.google.com/site/eipmacrote2016/home>

INCREASING THE INSTITUTIONAL PERFORMANCE OF THE POLITEHNICA UNIVERSITY TIMIȘOARA BY STRENGTHENING THE R & D AND TECHNOLOGICAL TRANSFER CAPACITY IN THE FIELD OF “ENERGY, ENVIRONMENT AND CLIMATE CHANGE”

Goal of the project

The overall objective of the PERFORM-TECH-UPT project is to increase the institutional performance of the Politehnica University Timisoara (UPT), by developing the R & D capacity of the Research Institute for Renewable Energy, a structure of UPT, by expanding and consolidating its activities in the field of intelligent specialization Energy, Environment and Climate Change, to serve the innovation requirements of economic operators from Romania West Development Region, respectively by intensifying the collaboration and visibility at national and international level.

Short description of the project

The PERFORM-TECH-UTP project is dedicated to the institutional development of UPT through targeted activities on human resources, research and development infrastructure and international visibility.

Project implemented by

Politehnica University Timișoara

Implementation period

October 16th, 2018 – December 10th, 2020 (26 months)



Main activities

- Project management and coordination
- Acquisition of significant R&D equipment and services
- Financial support for attending prestigious international conferences
- Stimulate the publication of articles in WOS indexed journal, located in the Q1
- Stimulation of the doctoral research activity of the last year of internship for the successful completion of the experimental part of the thesis
- Identifying funding opportunities for research and the development of successful applications
- Development of a portfolio of new products / technologies / methods / systems / services or significantly improved
- Selection of postdoctoral researchers in the field of the project
- Integration and testing of purchased equipment within research centers / laboratories
- Creating the site www.research.at.upt.ro

Results

- Ensuring an efficient project management
- Hiring 3 scientific researchers
- Supporting participation in over 15 international prestigious conferences
- Publication of 5 articles in ISI journals indexed in the first 2 quartiles
- Development of www.research.upt.ro web page
- Financing of 2 doctoral internships
- Ensuring access to various databases and archives (MathSciNet, WoS, Scopus etc.)
- Testing and integrating the equipment purchased in the first 2 stages
- Improving RDI infrastructure
- Acquisition of specific maintenance and repair services for equipment / devices, respectively for repairs and arrangement of university spaces

Financed through/by

Ministry of Education, "Program 1 - Development of the National Research and Development System, Subprogram 1.2 - Institutional Performance", National Plan for Research, Development and Innovation for the period 2015-2020 (PNCDI III), Institutional Development Project - CD Excellence Funding Project.

Research centre

1. Research Institute for Renewable Energy
2. Research Centre for Smart Energy Conversion and Storage
3. Research Centre for Mechanics of Materials and Structural Safety
4. Research Centre for Processing and Characterization of Advanced Materials
5. "Ștefan Nădășan" Research Laboratory for Strength, Integrity and Durability of materials, structures and conductors.

Research team

Assoc. Prof. Liviu CĂDARIU-BRĂILOIU, PhD
Prof. Eng. Viorel-Aurel ȘERBAN, PhD
Prof. Eng. Viorel UNGUREANU, PhD
Prof. Eng. Nicolae MUNTEAN, PhD
Prof. Eng. Liviu MARȘAVINA, PhD
Prof. Eng. Petru NEGREĂ, PhD
Assoc. Prof. Eng Bogdan RADU, PhD

Contact information

Assoc. Prof. Liviu CĂDARIU-BRĂILOIU, PhD
Department of Mathematics
Address: Piața Victoriei, No. 2, Postal Code 30006, Timișoara
Phone: (+40) 256 403100
Mobile: (+40) 725 890983
E-mail: liviu.cadariu-brailoiu@upt.ro
Web: <http://www.performtech.upt.ro/>

INOVATIVE METHOD FOR LANDFILLING OF MUNICIPAL SOLID WASTE INCINERATION RESIDUES BY STABILIZATION/SOLIDIFICATION INTO COAL FLY ASH ROCK MATRIX RESULTED FROM DENSE SLURRY TECHNOLOGY

Goal of the project

The project goal is treatment of MSWI residues by stabilization/solidification by means of using a binder matrix. The aim of this process is to create new compounds in a stabilized form that encompassing the harmful elements, which are non-hazardous or less hazardous than the raw (initial) material.

Project includes a series of experiments for embedding the MSWI residues into the coal fly ash rock matrix with the support of the preview research results. There will be done a small scale landfill disposal, in order to investigate the leaching behavior on environmental conditions for tracking the pollutants concentrations migration into environment.

Short description of the project

The project concept is based on using fly ash and desulphurization products related to coal incineration as a binder material to stabilize through solidification process the pollutants (heavy metals mostly) contained in MSWI residues.

Project implemented by

Politehnica University Timișoara

Implementation period

01.05.2018 - 30.04.2020

Main activities

The main activity of the project is to assess the discharge behavior of the experimental landfill disposal exposed into environmental conditions.

In this demand the following activity were foreseen:

- Construction of the experimental demonstrator.
- Evaluate the waste characteristics.
- Construction of the experimental landfill disposal according to the proposed technology.
- Leaching and percolation sampling.
- Lab analyses of experimental samples. Data recording.
- Processing and analyses of the experimental data.
- Interpretation of experimental data.
- Model the environmental behavior of the waste.
- Validate the model by calibration with the results from laboratory tests and field experiments and by comparing it to natural analogues.

Results

Stage I (2018) – Up-grading the existing lab demonstrator. Technical design. Purchasing of equipment.

- 1.1 Preparation of design documents.
- 1.2 Designing installations for upgrading the experimental demonstrator in accordance with the proposed technology.
- 1.3 Elaboration of technical datasheets for equipment purchasing.
- 1.4 Launch of the public procurement procedure in accordance with the legislation in force.
- 1.5 Reception of purchased equipment. Equipment payment.

Stage II (2019) – Construction of experimental demonstrator (upgrade). First run. Testing. Lab analyses

- 2.1 Integration on technological assembly

Applicability and transferability of the results

The solidification/stabilization method of different types of toxic residues consists of using a binder matrix, which is non-pollutant for the environment with the aim to encapsulate the harmful chemical compounds.

In this regard most of the applied technologies are using cement based binder matrix material which is an expensive material in comparison with coal fly ash and associated flue gas desulphurization (FGD) by-products related to coal power plants.

In fact the coal fly ash and FGD by-products are residues that end into open landfill disposal, which means that are costs free.

More than that is well known that cement factory worldwide are using coal fly ash as material basis for different types of cements, for their cementitious properties given by the pozzolanic compounds like silica (SiO₂), alumina (Al₂O₃), and iron oxide (Fe₂O₃) that exceeds over 80% of the fly ash composition.

The new proposed technology based on using fly ash and desulphurization by-products related to coal incineration as a binder material according to solidification/stabilization method, will eliminate the costs with the cement, which could bring considerable economical savings.

From environmental point of view the incineration residues (fly ash and FGD by-products) related to coal incineration can be used as binder material according to the proposed concept of solidification/stabilization method, with the aim to prevent ground water pollution by leaching phenomenon developed on open landfill disposals by dense slurry technology.

Financed through/by

Executive Agency for Higher Education, Research, Development and Innovation Funding – UEFISCDI /
PN-III-P1-1.1-PD-2016-1093

Research centre

Research Institute for Renewable Energies – ICER

Research team

Research contract director /Coordinator:

Eng. Mihail Reinhold WÄCHTER, PhD

Mentor:

Prof. Daniel DAN, PhD

Contact information

Eng. Mihail Reinhold WÄCHTER, PhD
Faculty of Mechanical Engineering
Address: Blvd. Mihail Viteazu, No.1, 300222, Timisoara
Mobile: (+40) 742 171 963
E-mail: wachter_reinhold@yahoo.com
Web: https://www.ct.upt.ro/centre/reco/wir-stab-01_ro.htm

RESEARCH CONCERNING CHARACTERIZATION AND IMPROVEMENT OF THE ELECTROMAGNETIC ENVIRONMENT IN MODERN CARS

Goal of the project

- Assessment of the electromagnetic environment in modern vehicles: technical and legal aspects;
- Assessment and analysis of measuring and testing methods and of equipment involved in Automotive EMC;
- Implementation of novel test and measurement methods in Automotive EMC and improvement of the testing repeatability
- Applications of metamaterials to Automotive EMC.

Short description of the project

This project is component of the complex project *Hybrid Platform for Communication in Visible Light and Augmented Reality for the Development of Intelligent Systems for Assistance and Active Security of Vehicles*, 21PCCDI / 2018.

Project implemented by

Politehnica University Timișoara,
Faculty of Electronics, Communications and Information Technology,
Department of Measurements and Optical Electronics

Implementation period

18.05.2018 - 16.11.2020

Main activities

1. Characterization of the electromagnetic environment in vehicles:
 - Near field and far field measurement;
 - Spectral occupancy measurement.
2. Improvement of repeatability of Automotive MC tests
 - Assessment of devices and equipment involved;
 - Interlaboratory testing and comparisons
 - Far-field prediction from near-field measurements data;
 - Prediction of far-field radiation from current measurement.
3. Methods of reduction of conducted and radiated emissions;
 - Resonance analysis of systems that fail EMC tests;
 - Applications of metamaterials: filtering, suppressing of cavity oscillations, screening with frequency selective surfaces.

Results

2018-2019

- Documentations and reports concerning assessment of electromagnetic field in modern cars;
- Documentations and reports concerning EMC Automotivex inter-laboratory comparisons, chamber validation and equipment assessment;
- Documentation and reports concerning applications of periodic structures in the Automotive EMC field;

21 published papers on:

- Application of Frequency Selective Surfaces (Fig. 1);
- Interlaboratory comparison of radiated emissions;
- ALSE chamber validation (Fig. 2);
- Stripline measurements in Automotive EMC;
- Near field measurements and applications to emission reduction (Fig. 3);
- Frequency selective surfaces;
- Spectrum occupancy measurement in the HF domain;
- Application of Raspberry Pi.

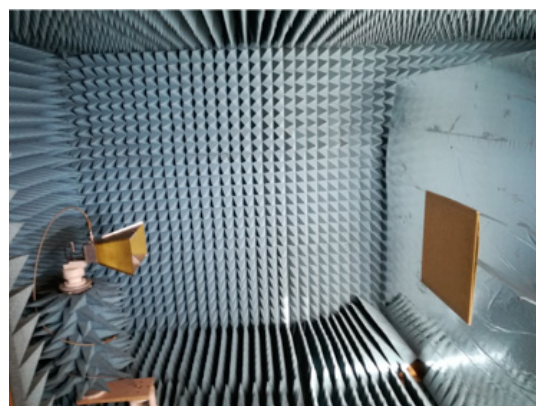

Fig. 1. Spatial filter based on a frequency selective surface tested in anechoic room



Fig. 2. Testing setup for chamber validation with biconic antenna in semi-anechoic room

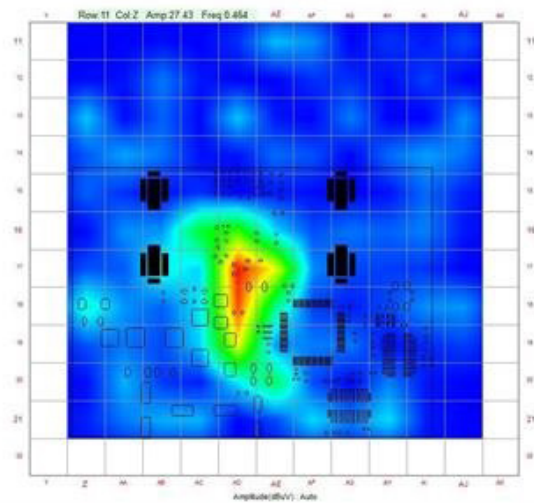

Fig. 3. Near-field scanning result

Applicability and transferability of the results

Results obtained in this research might be useful to:

- EMC laboratories, mainly related to Automotive industry;
- EMC professionals;
- EMC research community;
- EMC standards elaboration;
- Legal authorities that regulate spectrum occupancy;
- Professionals working in Automotive design.

Financed through/by

Executive Unit for Financing Higher Education, Research, Development and Innovation - UEFISCDI

Research centre

ICER - Research Institute for Renewable Energy

Research team

Aldo de SABATA
Cornel BALINT
Septimiu MISCHIE
Cora IFTODE
Andrei SILAGHI

Contact information

Prof. Aldo DE SABATA, PhD
Faculty of Electronics, Communications and Information Technology
Department of Measurements and Optical Electronics
Address: Bd. V. Pârvan, No. 2, Postal Code 300223, Timisoara
Phone: (+40) 256 403370
E-mail: aldo.de-sabata@upt.ro
Web: <http://www.meo.etc.upt.ro/>

INTELLIGENT CONTROL SYSTEM FOR CONTINUOUS CASTING BASED ON WATER FLOW CONTROL IN THE SECONDARY COOLING

Goal of the project:

This project deals with the development of metamaterial structures composed tessellations of mainly two types of open cells: truncated hexahedron tessellation (the Kelvin structure, a) and hollow sphere tessellation (b). The structures will be modelled using computer aided design software and their mechanical properties will be evaluated using finite element analysis software. When the desired geometries will be developed, the CAD file will be exported to a rapid prototyping machine for manufacturing.

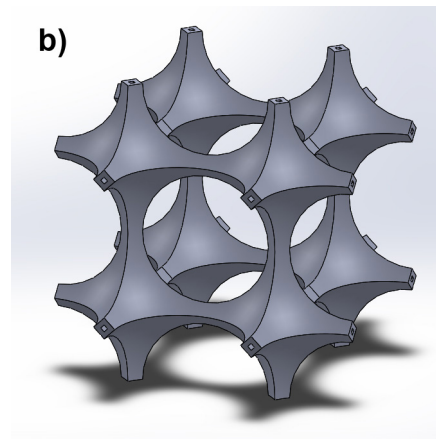
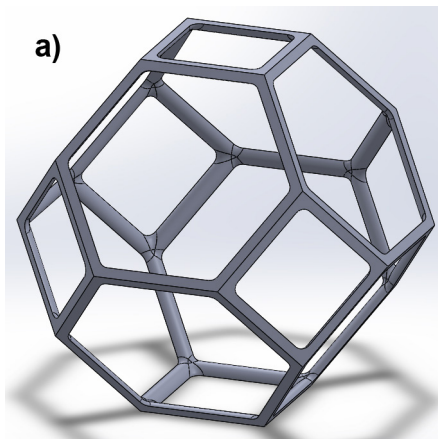

Short description of the project:

This project addresses a subject in the field of innovative materials and it deals with the design and manufacturing of structures composed of engineered materials whose properties are not found in nature (metamaterials). The metamaterials proposed for this project will consist of cellular polymeric lattices, whose properties will be controlled through geometric parameter manipulation (strut thickness, cell size and shape). The main applications of these structures will be as cushioning and protective layers meant to absorb the deformations and impact energy of personal protective equipment. The project has two main stages. The first stage consists of the design and simulation of the structures in order to determine the optimal parameters in terms of mechanical properties. The second stage of the project will deal with the manufacturing of the structures through rapid prototyping and the experimental determination of their mechanical characteristics. The comparison between the estimated and experimentally determined properties will validate the designs of the structures, allowing for complex geometry modelling for actual safety equipment applications.

Project implemented by

Politehnica University Timișoara

Implementation period:

1.5.2018 – 30.4.2020

Main activities:

01. Literature survey concerning metamaterial structures and additive rapid prototyping techniques.
 - A1.1. Literature study concerning mechanical metamaterial structures
 - A1.2. Literature study concerning rapid prototyping techniques for polymers
02. Development of parametrical metamaterial structures
 - A2.1. Design of metamaterial structures based on Kelvin cells
 - A2.2. Design of metamaterial structures with hollow sphere cells
03. Numerical evaluation of the mechanical properties of the developed metamaterial structures
 - A3.1. Determination of the mechanical properties of the polymers used in rapid prototyping
 - A3.2. Evaluation of the static mechanical properties of the developed structures
 - A3.3. Evaluation of the impact and energy absorption properties of the developed structures
 - A3.4. Optimization of metamaterial structures

- 04. Manufacturing of metamaterial structures
 - A4.1. Parameter adjustment for structure manufacturing through rapid prototyping
 - A4.2. Manufacturing of designed structures through additive rapid prototyping
- 05. Experimental determination of the mechanical characteristics of the manufactured structures
 - A5.1. Elaboration of static tests in compression on the manufactured structures
 - A5.2. Elaboration of static tests in bending on the manufactured structures
 - A5.3. Elaboration of fatigue tests in compression on the manufactured structures
 - A5.4. Elaboration of impact tests on the manufactured structures
- 06. Structure validation and product component design
 - A6.1. Comparison of results and simulation optimization
 - A6.2. Design of safety equipment components based on metamaterial structures
 - A6.3. Numerical analysis of the designed components' behavior in impact applications

Results:

After the first year of implementation, several structures were generated, and the variation of relative stiffness with the structure parameters was investigated.

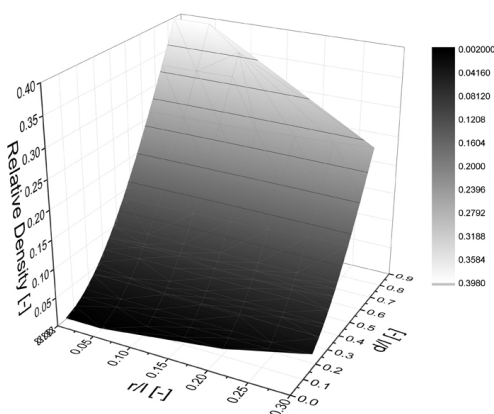

The geometries were imported into a finite element analysis software and the relative stiffness and relative strength variation with relative density was determined.

Partial results were published in an article entitled "A parametric study of the mechanical properties of open-cell Kelvin structures" and presented at the international conference AMS18

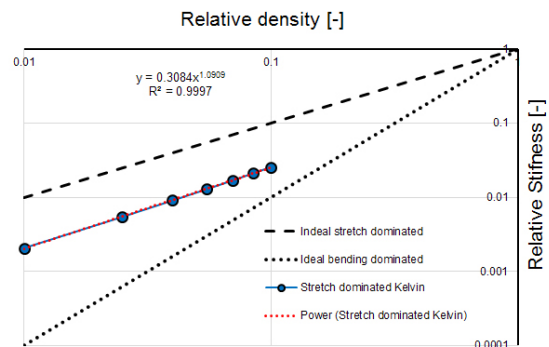

Applicability and transferability of the results:

The results obtained from this project can be implemented in safety equipment, for various types of industries, such as civil engineering (helmets), sports (protective equipment such as helmets, shin guards, padding), automotive (motorcycle suits) and defense (body and vehicle armor)

Financed through/by

UEFISCDI

Programul 1 - Dezvoltarea sistemului național de cercetare-dezvoltare

Research Center

1. Laboratorul Ștefan Nădășan, Politehnica University Timișoara
2. Medical Engineering Research Center, Politehnica University Timișoara
3. ICER - Research Institute for Renewable Energy, Politehnica University Timișoara

Research team

Eng. Dan-Andrei ȘERBAN, PhD

Prof. Eng. Nicolae FAUR, PhD

Contact information

Eng. Dan-Andrei ȘERBAN, PhD

Faculty of Mechanical Engineering

Department of Mechanics and Strength of Materials,

Address: 1 Miei Viteazu Blvd., Postal Code 300222, Timisoara

Phone: (+40) 256 403 741

Mobile: (+40) 721 866 598

E-mail: dan.serban@upt.ro

Web: <http://www.dserban.com/PD13-2018/>

SMART BUILDINGS ADAPTABLE TO THE CLIMATE CHANGE EFFECTS (CIA_CLIM)

Goal of the project

The specific objective of the project is centred on the increase of energy efficiency of buildings, by using smart facades with low-thermal transfer and smart energy efficiency through building automatization and solar energy collectors, through a modular laboratory demonstrative application. The resulted system, the smart house, is conceived thus to minimize the input energy for maintenance.

Short description of the project

The four component projects are focusing on two principal research directions:

- (i) use of smart facades with the low-thermal transfer, actively integrated for the enhancement of internal comfort and possessing a passive control of energy and
- (ii) smart energy efficiency through building automatization and solar energy collectors.



Project implemented by

Politehnica University Timișoara as coordinator (CO), in collaboration with

- Technical University of Civil Engineering of Bucharest (UTCB, P1),
- Technical University of Cluj-Napoca (UTCN, P2),
- National Institute for R & D in Electrical Engineering Bucharest (ICPE – CA, P3) and
- National Institute of R & D for Electrochemistry and Condensed Matter Timișoara (INCEMC, P4)

Implementation period

01.03.2018 - 30.06.2021

Main activities

Project 1 investigates the mechanical properties of cellular materials used as thermal insulations in smart façade systems, through mechanical compression, bending and toughness fracture testing.

Project 2 is focused on obtaining, characterizing and testing of high-property materials used for smart facades as thermal insulation materials and as support for special property layers: photo-catalytic layers and with reduced absorption/reflexion of UV-VIS-IR radiation.

Project 3 investigates the implementation of the electric power distribution in direct current for individual households or in small communities (smart-grid), with renewable energy sources integration.

Project 4 implements the knowledge and data resulted from projects no. 1-3 through a modular laboratory demonstrative application. The project will perform an integrated study on the influence of the facades and the energetic contribution to the internal comfort of the building.

Results

- Determination of mechanical properties of cellular materials used as thermal insulations in smart façade systems;
- Production, characterization and testing of high-property materials used for smart facades as thermal insulation materials and as support for special property layers;
- Implementation of the electric power distribution in direct current for individual households or in small communities (smart-grid), with renewable energy sources integration, finalizing with an experimental platform;
- Modular laboratory demonstrative application for the implementation of project results, performing a global study regarding the influence of the facades and the energetic contribution to the internal comfort of the building.



Applicability and transferability of the results

In the construction domain, the energy represents the key-point in achieving efficient buildings. All the results obtained in the frame of the project are expected to be of interest for the economic environment, from manufacturers to contractors. Design guidelines and recommendations will be provided.

Financed through/by

The project is supported by a grant of the Executive Unit for Financing Higher Education, Research, Development and Innovation (UEFISCDI), project number PN-III-P1-1.2-PCCDI-2017-0391 / grant agreement 30PCCDI/2018.

Research Centre

- ICER – The Research Institute for Renewable Energy, UPT (CO);
- “St. Nadasan” Research Laboratory for Strength, Integrity and Durability of materials, structures and conductors, UPT (CO);
- Research Center of Environmental Science and Engineering, UPT (CO);
- Intelligent Control of Energy Conversion and Storage Research Center, UPT (CO);
- ACTEX – Integrated Platform of Research and Development for the Behaviour of Structures under Extreme Actions, UPT (CO);
- CAMBI – Advanced Research Center for Ambiental Quality and Building Physics, UTCB (P1);
- EEC – Energy Efficiency in Buildings, UTCB (P1);
- RLSDEPE – Research Laboratory and Sustainable Development in Electronics and Power Electronics, UTCN (P2);
- Department for Efficiency in Conversion and Consumption of Energy, ICPE – CA (P3);
- Renewable Energies – Photovoltaics – Laboratory, INCEMC (P4);
- Chemical and Electrochemical Synthesis Department, INCEMC (P4).

Research team

The research team is composed by 90 researchers of the five institutions.

Contact information

Prof. Viorel UNGUREANU, PhD
Faculty of Civil Engineering
Department of Steel Structures and Structural Mechanics
Address: Str. Ioan Curea, No. 1, 300224, Timișoara
Phone: (+40) 256 403912
Mobile: (+40) 740 137640
E-mail: viorel.ungureanu@upt.ro
Web: <https://www.icer.ro/cercetare/proiecte-de-cercetare/cia-clim>

SINTERIZATION OF NOVEL STRUCTURES FOR ALLOYS WITH INCREASED FUNCTIONALITY (SINS), PN-III-P3-3.1-PM-RO-CN-2018-0027

Goal of the project

The SINS collaborative research project was based on the complementary experience of the two groups aims to design and manufacture sintered materials (including porous or with gradient) belonging to the intelligent materials class of materials, with the primary focus on NiTi based alloys.

Short description of the project

- The objectives of the project are related to the fabrication and characterization of complex metallic powders and to the production of sintered materials by spark plasma and by laser additive method.
- The collaboration used both the experience of the research groups in Romania and China, as well as the scientific research infrastructure in the partner's institutions for the development of new technologies in order to manufacture high-performance intelligent materials, with wide potential use, ranging from the biomedical to the automotive industry.

Project implemented by

- Politehnica University Timisoara
- University of Science and Technology Beijing

Implementation period

2018-2019

Main activities

- Preparation and characterization of complex metal powders
- Identification of the compatibility between components for porous structures
- Design of technologies for producing the sintered materials
- Fabrication and characterization of sintered materials
- Dissemination

Results

- Mechanical alloying experiments

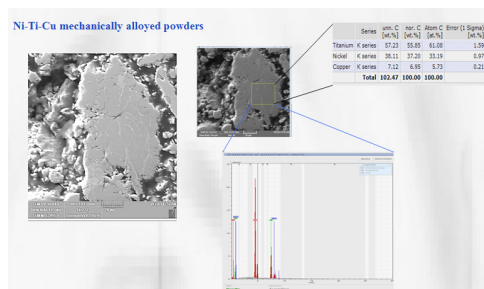

Laser sintering experiments

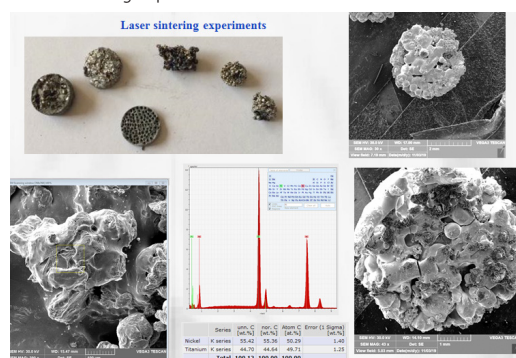

Collaborations



Applicability and transferability of the results

- The materials developed have the potential to be used in medical applications.
- A solid transfer of knowledge occurred during the collaboration between the partners involved in the research.

Financed through/by

The project is supported by a grant of the Executive Unit for Financing Higher Education, Research, Development and Innovation (UEFISCDI), project number PN-III-P3-3.1-PM-RO-CN-2018-0027

Research Centre

- Smart Materials and Structures Laboratory

Research team

Politehnica University Timisoara:

Prof. Corneliu M. CRACIUNESCU
Ph.D. student Roxana SPRINCENATU
Ph D. student Andrei NOVAC
Ph D. student Vlad BOLOCAN
Ph.D. student Vlad NICOLAESCU

University of Science and Technology Beijing:

Prof. Xingke ZHAO
Ph D. student Xuan QIN
Ph.D. student Peng ZHANG
Ph.D. student Zunyue YU

Contact information

Prof. Corneliu CRACIUNESCU, PhD, Habil.
Faculty of Mechanical Engineering Department Materials and Manufacturing Engineering
Address: Bd. Mihai Viteazu , No. 1. 300026, Timisoara
Phone: (+40) 256 403 655
Mobile: service not paid by the university !!!
E-mail: corneliu.craciunescu@upt.ro
Web: http://www.upt.ro/img/files/2018-2019/cercetare/ppr/Proiect_RO-CN-SINS.pps

NATURE-INSPIRED MODELING AND OPTIMIZATION TECHNIQUES OF FUZZY CONTROL SYSTEMS WITH MECHATRONICS APPLICATIONS

Goal of the project

The aim of this project is to demonstrate efficiency and prove the viability of an innovative tuning approach for fuzzy control systems using nature-inspired algorithms in control structures modeling and optimization stages. In this framework, combining nature-inspired optimization algorithms with fuzzy control structures, will have a significant impact on the performance of fuzzy control systems.

Short description of the project

The nature-inspired optimization algorithms will be employed in solving optimization problems that minimize discrete-time objective functions expressed as integral or sum-type quadratic performance indices.

Project implemented by

Politehnica University Timișoara

Implementation period

19.10.2018 - 18.10.2020

Main activities:

The main activities are:

1. Development of efficient control solutions for different processes by bypassing the higher derivative calculations;
2. Takagi-Sugeno fuzzy controllers' optimization through minimization of several objective functions;
3. Development of performant solutions with a reduced implementation cost;
4. Experimental validation of proposed control solutions;
5. Achievements dissemination in high visibility journals and conferences;
6. Successful project management administration.

Results

The main results are related to development of nature inspired algorithm-based solutions for solving optimization problems of fuzzy systems will be disseminated at national and international levels as: four papers published in Thomson Reuters Web of Science (formerly known as ISI Web of Knowledge) publications and four presentations at international conferences.

Applicability and transferability of the results

The results obtained during this contract belong exclusively to Politehnica University Timișoara.

Financed through/by

Executive Agency for Higher Education, Research, Development and Innovation Funding

Research Centre

Faculty of Automation and Computers

Research team

Eng. Radu-Codruț DAVID, PhD
Prof. eng. Stefan PREITL, PhD

Contact information

Eng. Radu-Codruț DAVID, PhD
Faculty of Automation and Computers
Department of Automation and Applied Informatics
Address: Bd. V. Parvan 2, 300223 Timisoara, Romania
Phone: (+40) 722 254450
E-mail: davidradu@gmail.com
Web: aut.upt.ro

DEVELOPMENT OF ECO-FRIENDLY COMPOSITE MATERIALS BASED ON GEOPOLYMER MATRIX AND REINFORCED WITH WASTE FIBRES

Goal of the project

The project is an answer for a specific challenge regarding waste management, recycling and urban mining. The goal of the project is to prepare a broad spectra of advanced and progressive new composite materials based geopolymer matrices and reinforced with natural waste fibres. The application of these new materials will be the construction industry with a high potential of commercial utilization and potential replacement of conventional materials.

Short description of the project

This project deals with the development of new composite materials for construction industry, based on waste products.

Project implemented by:

Project coordinator: Cracow University of Technology.

Partners: Nigde University Turkey, Pontificia Universidad Católica del Peru, Riga Technical University Latvia, Babeş-Bolyai University, Catholic University of Uruguay Damas Antonio Larrañaga, Politehnica University Timișoara.

Implementation period

02/01/2017 – 31/12/2019

Main activities

- WP1. The selection of waste materials for hydrothermal alkalization and therefore to be turned into new materials based on geopolymer matrix for construction applications
- WP2. The selection of waste materials (natural fibres) as a fillers and therefore turned into new composites for construction application
- WP3. Optimization of properties using computer methods for the new materials and structural elements
- WP4. The research into the application of new materials – comparison of the functional properties of the materials
- WP5. Analysis of practical applications of new materials for construction application and testing prototype components in laboratory as well as validated it in relevant environment

Results

The year 2017 had deadlines for the first two Work Packages. WP1, coordinated by Nigde University, dealt with the identification of waste materials for the composite material matrices. Each participating partner performed a survey of possible waste material candidates available in their region (recycled clay bricks and volcanic ash in Peru, fly ash in Turkey, Argentina and Romania, paper mill sludge and rice husk ash in Uruguay and granulated rubber from waste tyres in Poland).

WP2, coordinated by Babeş-Bolyai University, dealt with the identification of waste natural fibres as reinforcements for the composites. As with WP1, each participating partner proposed waste materials available in their region (mostly hemp and flax fibres).

Applicability and transferability of the results:

The new composite materials that will be developed in this project will be tested and their properties compared with conventional construction materials. If the mechanical and thermal behaviour is comparable between the two categories, the newly developed materials will be proposed for replacing traditional materials in each specific region where the waste products are available.

Financed through/by

Horizon 2020 - ERA Net Latin America and Caribbean Countries/UEFISCDI

Research Center

Ștefan Nădășan Laboratory

Research team

Eng. Dan-Andrei ȘERBAN, PhD – Project manager
Prof. Eng. Liviu MARȘAVINA, PhD
Eng. Radu NEGRU, PhD
Eng. Emanoil LINUL, PhD

Contact information

Eng. Dan-Andrei ȘERBAN, PhD
Faculty of Mechanical Engineering
Department of Mechanics and Strength of Materials,
Address: Mihai Viteazu Str., No. 1 Postal Code 300222, Timisoara
Phone: (+40) 256 403 741
E-mail: dan.serban@upt.ro

Research and Development Projects for Young Researchers

MODULAR GREEN WALLS (MODGREW)

Goal of the project

The goal of the project is based on studies of natural elements' response to external stimuli. The study of modular green/vegetated wall systems aims to determine optimal responsive surface organizations, while testing materials and geometry in various conditions. The project uses digital modelling based on algorithms for simulation and testing of prototypes.

Short description of the project

MODGREW, modular green wall, is an interactive system that reacts to external stimuli.

Implementation period

01.02.2019 – 15.06.2020

Budget

47.600 RON (10000 EUR)

Main activities

- The green installation concept is made out of interactive modular systems, creating a new, living, dynamic, interactive structure whose inspiration is taken from nature while using biomimicry as main principle for its development. This new concept responds and is influenced by external, natural stimuli or by the human factor. We added a new direction to the research in order to use simple materials (wood/ pvc) that react to external environmental stimuli (humidity, light, movement). We aim to use the minimum required sensors to supplement certain actions in a simple "natural" manner.

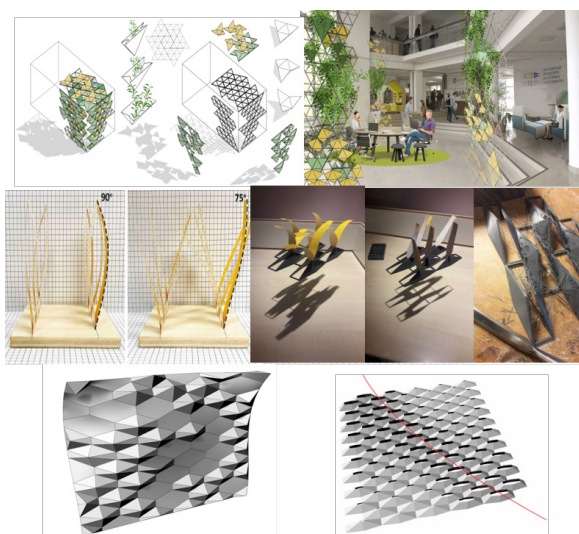

Results

- The presentation of the research results is done in specific international conferences and articles written for journals and symposiums. Their materialization involved the realization of prototypes at different scales.
- The estimated impact of the project in the scientific context can be significant in the direction of transforming a simple support for plants into an interactive mechanism that takes into account the natural growing needs of the sustained plants. Inspired by nature, and how plants and simple materials react to external light, temperature and humidity, the proposed interactive structure acquired an exterior skin to optimize environmental interaction.

Applicability and transferability of the results:

This new architectural concept inspired by kinetic and biomimetic design, represents an innovative approach to existing environmental elements, opening new directions of research.

Research team

ANGHEL Anamaria Andreea
MOHORA Irina
PREDA Alma-Dia
GIUREA Diana
FRIGURĂ-ILIASA Flaviu M
MILINCU Camil

Contact information

Assist. Prof. Anamaria Andreea ANGHEL, PhD
Faculty of Architecture and Urban Planning
Department of Architecture
Address: Str.Traian Lalescu, No.12/A Postal 300223, Timisoara
Phone: (+40) 256 404 021
Mobile: (+40) 723776997
E-mail: andreea.anghel@upt.ro
Web: <https://www.arh.upt.ro/>

PREDICTION AND MANAGEMENT OF URBAN TRAFFIC CONGESTION USING MACHINE LEARNING

Goal of the project

The project intends to develop reliable methods of predicting urban traffic congestion in Timisoara, using machine learning methods and tools with emphasis on “random faults” in transportation networks: what happens when there is a traffic accident during rush hour and how could we mitigate the impact by using adaptive traffic signaling plans.

Short description of the project

Using historic data and traffic microsimulation we train a model for predicting the impact of traffic accidents over the transportation network of Timisoara

Implementation period

01.02.2019 – 31.07.2020

Budget

47.600 RON (10000 EUR)

Main activities

1. Technical activities consist of collection and aggregation of pertinent data regarding the state and quality of traffic on all the segments of the area under study. Each set of data is manually annotated with data regarding traffic incidents and special circumstances (road closure, flow deviation etc.).
2. Next, we use the data for training a machine learning model and use the resulting model for predicting, short time horizon, of up to 30 minutes, the flow of traffic in the adjacent area of the incident.
3. Scientific activities consist of presenting the results of our work a relevant conference (2 international conferences) and publishing in relevant journals.

Results

- At the current stage of the project we have ingested full data regarding Timisoara, over the last 215 days (12 samples/hour=61920 samples) and have annotated the sets with relevant metadata: weather, holidays, public events and traffic incident data (through the partnership with the local authorities). provide us with the means for advancing towards the final goal of the project
- The main issue we found is the scarcity of the data for a thorough training of the machine learning model, consequently we developed a framework for generating large sets of data through traffic micro-simulation, using PTV Vissim, under a large variety of circumstances. The results of this stage are going to

Applicability and transferability of the results:

The results of the project have direct applicability to the improvement of the quality of transportation in Timisoara. We already have a fruitful collaboration with the city's transportation authorities and traffic management control. Available results are going to be first used for cross-validating actions during minor traffic incidents while input from the stakeholders is used in fine-tuning the algorithm

Research team

Alexandru IOVANOVICI,
Lucian PRODAN,
Dacian AVRAMONI,
Anca-Maria MOSCOVICI,
Alexandru TOPÎRCEANU

Contact information

Assist. Prof. Alexandru IOVANOVICI, PhD
Faculty of Automation and Computers: Bld. Vasile Pirvan nr.2
Phone: (+40) 256 403 278
E-mail: iovanalex@cs.upt.ro
Web: <https://cs.upt.ro/people/profile/alexandru-iovanovici>

BIOREACTOR FOR CONTROLLED/ADVANCED DEGRADATION OF POLYMERIC MATERIALS

Goal of the project

The main goal of the project is the development and implementation of an innovative technology that would reduce the impact of plastic waste onto environment. In this respect, a new technology of degradation based on a laboratory scale aerobic bioreactor will be designed. Plastic waste will be fed inside the bioreactor and would provide the carbon source necessary for the proliferation of bacteria. The polymeric material will be turned into compost after this biodegradation step, and would no longer be a threat for the environmental equilibrium.

Short description of the project

New technology of polymeric materials biodegradation inside a self-designed bioreactor fed with natural occurring bacteria or pure culture inocula. The biodegradation will take place in aerobic conditions, under continuous stirring and thermostat temperature, which allows the formation of microbial consortia.

Implementation period

01.02.2019 – 31.07.2020

Budget

47.600 RON (10000 EUR)

Main activities

- A1.1. Design and testing of laboratory scale bioreactor. Process control parameters: temperature and pH.

The Bioreactor is made up of a sealed glass tank, with continuous stirring, thermostat unit, aeration device, sampling ports and pH monitoring systems (fig. 1).



- I.2. Air pumping system calibration. CO₂ monitoring system
The air flow is provided by an air compressor and adjusted by means of a flowmeter. The air could be conducted through a HEPA filter system. The carbon dioxide is measured by an IR sensor mounted inside a separate cell.
- I.2. Air pumping system calibration. CO₂ monitoring system
The air flow is provided by an air compressor and adjusted by means of a flowmeter. The air could be conducted through a HEPA filter system. The carbon dioxide is measured by an IR sensor mounted inside a separate cell.

Results

- The tested glycopolymer displayed good biodegradation pattern inside the bioreactor. The weight loss was measured from time to time and kinetic modeling was performed in order to foresee the operating performances of the bioreactor. TG and FTIR analyses confirmed the structural modification of the glycopolymer samples during biodegradation. These findings were published as ISI articles and conferences.

Applicability and transferability of the results:

1. Pană A.M., et al., Biodegradation studies on new glycopolymers derived from oligomeric D-mannose itaconates and 2-hydroxypropyl acrylate, Polym Degrad Stabil, 2019, 167, 210-216, I.F. = 3,78
2. Pană A.M., et al. Preliminary study on polymer degradation using an aerobic reactor, J Environ Prot Ecol, 2019, 20(4), 1951-1959, IF = 0.25
3. Pană A.M., et al., Efficiency of an Aerobic Bioreactor for Glycopolymer Biodegradation, Proceedings of 9th International Conference on ENERGY and ENVIRONMENT (CIEM), IEEE Xplore, 2019, 129-132
4. Pană A.M., et al., Preliminary study on polymer degradation using an aerobic reactor, Environmental Engineering and Sustainable Development, 7th Edition, June 20-21th, Alba Iulia.
5. Roman R., Pană A.M., Dumitrel G.A., Studii preliminare a biodegradării unor polimeri zaharidici utilizând un bioreactor aerob, Simpozionul Științific Studentesc al Facultății de Chimie Industrială și Ingineria Mediului, ediția a III-a, 14 Iunie 2019.

Research team

PANĂ Ana-Maria, DUMITREL Gabriela- Alina, GHERMAN Vasile, RUSU Gerlinde, STĂNESCU Alina Stanescu

Contact information

Assist. Prof. Ana-Maria PANĂ, PhD
Faculty of Industrial Chemistry and Environmental Engineering
Address: 6 Vasile Parvan Blvd. 300223, Timișoara
Phone: (+40) 256 403067
Mobile: (+40) 727853935
E-mail: anamaria.pana@upt.ro

MODERN PHOTOGRAMMETRIC TECHNOLOGIES UTILIZED IN BITUMINOUS LAYER MONITORING

Goal of the project

The project presents solutions, sustained by case studies, regarding the geospatial data acquisition, processing and interpretation using modern photogrammetric technologies in bituminous layer monitoring.

Short description of the project

The project' two main objectives are: regular monitoring of the bituminous garment degradation status evolution and thermal regime evaluation in a bituminous garment at certain time intervals.

The project proposes the degradation status evolution monitoring and the thermic regime evaluation for a bituminous layer, during its execution, using images acquired with a UAV.

Implementation period

01.02.2019 - 31.07.2020

Budget

49.200 RON

Main activities

For the degradation status evolution assessment there are provided two flights at intervals of six months between them, in order to determine the type and extent of the defects from the surface of a bituminous layer, as well as the clogging state of the clogging devices.

The flights, aimed at determining the thermal regime, are performed on the same day on a sector on which a bituminous layer is realized.

Three values will be obtained: at the time of mixing, at the beginning of the compaction and at the end of the works. Also, based on the obtained depth results, a temperature profile on the executed layer thickness will be drafted.

Results

The geospatial and thermal data collected on the experimental sectors were analyzed, processed and georeferenced, obtaining specific photogrammetric products (i.e. DSM - Digital Surface Model), and information regarding the bituminous layer temperature when it is put into operation (squeezing, compacting, commissioning).

DSM - Digital Surface Mode - Visual Vision

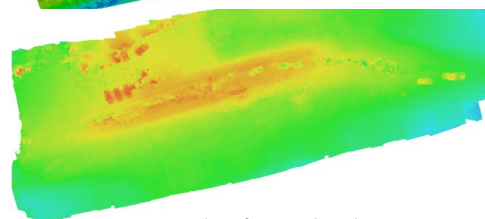
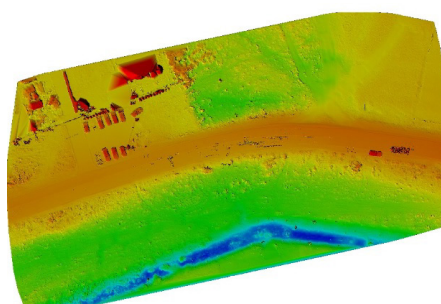

DSM - Digital Surface Mode - Thermic Vision

Applicability and transferability of the results:

Following the correlation of both the results obtained by classical methods (the temperatures determination by direct measurements made on the field and the degradation state evaluation using measurements made on the field) and the results obtained after processing, the method used in this project is more accurate and economical, representing a progress in the field of communication ways.

Research team

Lect. PhD. Eng. Viorica DAVID

Assoc. Prof. PhD. Eng. Cosmin MUȘAT

PhD. Stud. Eng. Ligia BELC

Assist. Prof. PhD. Eng. Maria – Roberta JIANU

Contact information

Assist. Prof. Viorica DAVID, PhD

Faculty of Civil Engineering

Address: Str. Traian Lalescu, No. 2A, 300223, Timisoara

Phone: (+40) 256 403983

E-mail: viorica.david@upt.ro

OBTAINING AND CHARACTERIZATION OF BULK AMORPHOUS ALLOYS WITH BIOCOMPATIBLE PROPERTIES

Goal of the project

The goal of the project is to propose new chemical composition and processing methods in order to obtain bulk amorphous alloys with biocompatible properties.

Short description of the project

The project's purpose is to develop new amorphous structured materials for biomedical devices.

Implementation period

01.02.2019 - 31.07.2020

Budget

47.600 RON (10000 EUR)

Main activities

During this project, the research team was focused on the following activities:

- Optimizing of a chemical composition that ensures high amorphization capacity;
- Processing of bulk amorphous alloys (rods and discs);
- Characterization of the obtained alloys regarding their structure and properties (DTA analysis, X-Ray diffraction, hardness testing, wear and corrosion resistance).

Results

Estimated results include:

- processing of a bulk amorphous alloy, with a chemical composition that ensures high biocompatibility and amorphization capacity;
- casting and processing technology of bulk amorphous alloys for biomedical devices (fixing plates rods);
- obtaining high quality new bulk amorphous alloys with applicability in the field of medical engineering.

Applicability and transferability of the results:

- The success of the research will open the way to obtain new materials with amorphous structure and improved properties, usable to produce different parts in the field of medical engineering.

Research team

Carmen OPRIȘ
Viorel-Aurel ȘERBAN,
Aurel RĂDUȚĂ,
Cosmin CODREAN,
Dragoș BUZDUGAN,
Dragoș UȚU,
Bogdan RADU,
Petru HIDIDIȘ

Contact information

Prof. Carmen OPRIȘ, PhD
Faculty of Mechanical Engineering
Department for Materials and Manufacturing Engineering,
Address: Bvd. Mihai Viteazu, No. 1, 300222, Timisoara
Phone: (+40) 256 403645
E-mail: carmen.opris@upt.ro

NONLINEAR CONTROLLERS WITH PARAMETERS TUNED USING EXPERIMENTS, DEDICATED TO AERODYNAMIC SYSTEMS

Goal of the project

Analysis, design and implementation of control solutions with nonlinear controllers: fuzzy control techniques mixed with other nonlinear techniques: VRFT, MFC, MFAC, ADRC and SMC in order to improve the control system (CS) performance and validate the new CSs with the proposed nonlinear controllers through experiments on laboratory equipment.

Short description of the project

Nonlinear controllers whose parameters are tuned using experiments are developed.

Implementation period

01.02.2019 - 31.07.2020

Budget

47.600 RON (10000 EUR)

Main activities

Main activities

1. Development of nonlinear controllers.
2. Combination of fuzzy logic with VRFT, MFC, MFAC, ADRC and SMC.
3. Deriving a mechanism to ensure the stability of CSs with nonlinear controllers in the frameworks of data-driven and fuzzy control.
3. Validation of the controllers on real-world processes in the labs of the research team.
4. Publication of results in visible conference and journal papers.

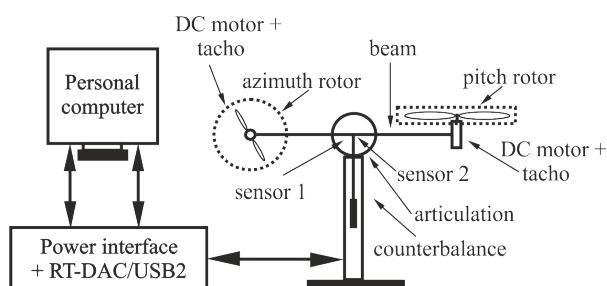

Results

The research team published one journal paper indexed in Clarivate Analytics Web of Science (WoS, with one of the previous names ISI Web of Knowledge) (link), impact factor = 2.707 according to Journal Citation Reports (JCR) published by Clarivate Analytics in 2018 in the gray zone (Q3) of the Energy & Fuels category.

Results - continuation

The research team published three conference papers currently indexed in the international data bases IEEExplore (link and link) and ScienceDirect (link). The proceedings of the previous editions of these conferences are indexed in WoS.

The last mentioned paper received Best Paper Award (link) at 7th International Conference on Information Technology and Quantitative Management ITQM 2019 (Granada, Spain).

Applicability and transferability of the results:

With the support of our partner from the University of Ottawa, the new CSs with nonlinear controllers presented in Energies journal and at 2019 IEEE International Conference on Systems, Man, and Cybernetics (SMC) are in the validation process at Ontario Centers of Excellence.

Research team

As.Dr.Ing. Raul-Cristian ROMAN
 Prof.Dr.Ing. Radu-Emil PRECUP
 Prof.Dr.Ing. Stefan PREITL
 Ș.I.Dr.Ing. Mircea-Bogdan RĂDAC
 Ș.I.Dr.Ing. Claudia-Adina BOJAN-DRAGOȘ
 Ș.I.Dr.Ing. Alexandra-Iulia SZEDLAK-STÎNEAN
 Drd.Ing Elena-Lorena HEDREA

Contact information

Assist. Raul-Cristian ROMAN, PhD
 Faculty of Automation and Computers,
 Department of Automation and Applied Informatics,
 Address Bd. V. Parvan 2
 300223, Timisoara
 Phone: +40 256403240
 Mobile: +40 728069445
 E-mail: raul-cristian.roman@upt.ro
 Web: <http://www.aut.upt.ro/~raul.roman/>

MODERN SOLUTIONS FOR STRENGTHENING FLAT SLABS, VALIDATED THROUGH NUMERICAL, PROBABILISTIC AND EXPERIMENTAL RESEARCH

Goal of the project

The goal of the project is to identify and validate modern and viable solutions for strengthening of deficient slab-column connections of reinforced concrete flat slabs. Another important objective, given the high applicability of the results, is represented by the enhancement of knowledge in the field and efficient dissemination and transfer of know-how towards third parties and industry.

Short description of the project

The study proposes solutions for enhanced punching shear capacity of reinforced concrete flat slabs.

Implementation period

01.02.2019 - 31.07.2020

Budget

47.600 RON (10000 EUR)

Main activities

- The main activity of the project resided in the experimental program that consisted of four tests performed on full-scale specimens reproducing slab-columns connections inside reinforced concrete flat slabs. The tests aimed to reveal the behavior of such specimens and to validate the proposed strengthening solutions.

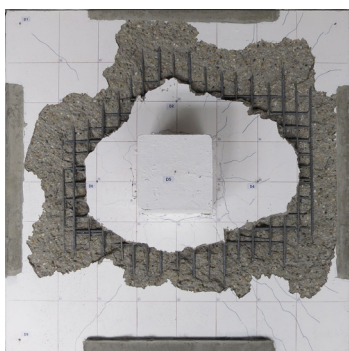

- The theoretical research approached methods used in order to numerically simulate the non-linear behavior of such slabs. Probabilistic methods were enabled in order to identify the parameters that impact the performance of the system and that of proposed strengthening solutions.

Results

- The capacity enhancement provided by the technique that uses high-performance fiber reinforced mortar is considered a very important result, as this technique is extremely technologically feasible. This facility of application is in contrast to the most existing techniques which have been proven to be applied in a cumbersome manner.
- The very good agreement between tests and numerical models proves that a stable solution for simulating the behavior of such structural elements was achieved. The numerical parametric study also gave vital information on the effectiveness of strengthening techniques.

Applicability and transferability of the results:

As flat slabs are quite in-fashion with civil engineers for newly designed multi-storey structures and the design and execution flaws are becoming relatively common, the results of the research are highly applicable for both designers and constructors worldwide. The industry will benefit by publishing of research results in highly visible scientific publications and professional meetings.

Research team

Lecturer Sorin-Codruț FLORUȚ, PhD
Lecturer Simon PESCARI, PhD
PhD Student Viorel Constantin TODEA
PhD Student Dan-Adrian POPESCU

Contact information

Assist. Prof. Sorin-Codruț FLORUȚ, PhD
Faculty of Civil Engineering
Address: 2nd T. Lalescu 300223, Timisoara
Phone: (+40) 256 403 942
Mobile: (+40) 751 158 188
E-mail: codrut.florut@upt.ro

EFFICIENT THREE-PHASE RECTIFIERS ENSURING UNITARY POWER FACTOR IN INDUSTRIAL APPLICATIONS

Goal of the project

The goal of the project is to ensure high energy efficiency, reduction of the current and voltage fluctuations from the output of the rectifier, respectively the conformity of the harmonics up to order 40 to the international standard IEC 61000-3-2.

Short description of the project

The aim of this research is to build the Vienna PFC rectifier topology.

Implementation period

01.02.2019 - 31.07.2020

Budget

47.600 RON (10000 EUR)

Main activities

- A.1. Analysis of the actual state of the art of the three-phase rectifiers able to provide unitary power factor in industrial applications.
- A.2. Theoretical study through modeling and simulation of the chosen topology.
- A.3. Dissemination of the results.
- A.4. Defining the data and the design framework of the chosen topology.
- A.5. Analytical design of the rectifier: choosing, sizing, checking components.
- A.6. Modeling/simulation/rectifier structure optimization.
- A.7. Design and purchase of PCBs.
- A.8. Purchase of components/equipment necessary for the construction/testing of the rectifier.

Results

- A comprehensive study of the PFC rectifier topologies existing in the specialized literature was carried out. From this study, 6 topologies were chosen. These were modeled and simulated. One of the 6 topologies was chosen for practical purposes. Then, rectifier design framework was defined, followed by its analytical design, namely the selection, dimensioning and verification of the components.
- The activities of optimizing the structure of the rectifier and designing the printed circuit boards (PCBs) followed.

- The latter (PCBs) and the electrical components necessary for the practical realization of the rectifier and the equipment for testing the rectifier were purchased. Then, the physical components were glued to the PCBs, resulting the physical rectifier, as shown in the below figure.

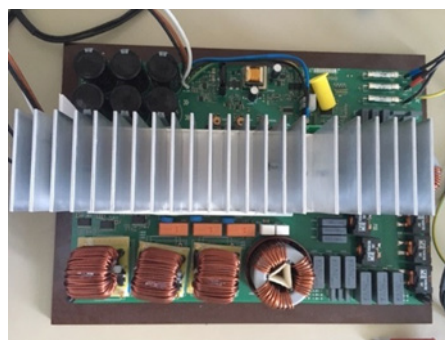

Applicability and transferability of the results:

It is typical for large industrial users to be penalized for one factor of net power less than 1, as they directly affect the distribution losses for a utility company. This can be prevented by correcting the power factor in this way so that the electricity grid works efficiently, the cost of power generation reducing, resulting in a saving of money for both the utility company and customers.

Research team

Mihaela Codruța ANCUȚI
Sorin MUȘUROI
Ciprian ȘORÂNDARU
Marcus SVOBODA
Marius Vlad VOIAN

Contact information

Asist. Prof. Mihaela Codruta ANCUȚI, PhD
Faculty of Electrical and Power Systems Engineering
Department of Electrical Engineering
Address: V. Parvan, 2, 300223, Timisoara
Mobile: (+40) 766 699 556
E-mail: codruta-m.ancuti@upt.ro

DEHAZING DATASETS AND TECHNIQUES TO EVALUATE CLASSIFICATION METHODS

Goal of the project

We aim to introduce several dehazing techniques and to build a dehazing dataset which can be used for testing and evaluation the effectiveness of existing classification techniques in the context of dehazing. The dehazing dataset will contain real reference and hazy images of the same scene recorded under the same illumination conditions. Based on these dehazing dataset, we will perform an extensive assessment of the existing dehazing methods.

Short description of the project

Development of image dehazing techniques and recording of realistic image dehazing dataset.

Implementation period

01.02.2020 - 31.07.2020

Budget

47.600 RON (10000 EUR)

Main activities

1. Developing state-of-the-art image dehazing techniques.
2. Recording of a realistic image dehazing dataset which can be used for testing and evaluation the effectiveness of existing classification techniques in the context of dehazing.
3. Evaluation of the recent image dehazing techniques.

Results

- We introduced/published a realistic image dehazing dataset:
 1. Codruta O Ancuti, Cosmin Ancuti, Radu Timofte, Luc Van Gool, Lei Zhang, Ming-Hsuan Yang, „”, Proceedings of the IEEE Conference on Computer Vision and Pattern Recognition Workshops, Long Beach, US, June 2019;
 2. Codruta O Ancuti, et al „Dense haze: A benchmark for image dehazing with dense-haze and haze-free images”, IEEE International Conference on Image Processing, Taipei, Taiwan, sept. 2019.

- We introduced several sota image dehazing/enhancement techniques:

1. Codruta O Ancuti et al., „Color Channel Transfer for Image Dehazing”, IEEE Signal Processing Letter , (Q1, impact factor 3.268).
2. Codruta O Ancuti, et al., „Color Channels Compensation (3C): A fundamental pre-processing step for image enhancement”, IEEE Transactions on Image Processing , (Q1, impact factor 6.79).

Applicability and transferability of the results:

Outdoor traffic scenes images often suffer from poor visibility introduced by haze. Haze is a common atmospheric phenomena produced by small floating particles that absorb and scatter the light from its propagation direction.

Due to attenuation and scattering, hazy scenes are characterized by poor contrast of distant objects, color shifting, and additional noise.

The outcome of this project is important for computer vision ADAS module in the automotive industry.

Research team

Codruta O. ANCUȚI
Arpad KIS
Cosmin ANCUȚI

Contact information

Assoc. Prof. Codruta O. ANCUȚI, PhD
Department of Measurements and Optical Electronics
Address: Str. Vasile Parvan, No. 2, 300023, Timisoara
Phone: (+40) 256 403363
E-mail: codruta-o.ancuti@upt.ro

EMBEDDED SOLUTIONS FOR DEEP NEURAL NETWORKS

Goal of the project

The goal of the project is to develop a technical solution that allows automatic transfer of Deep Neural Networks to dedicated embedded systems. Appropriate neural models need to be chosen in order to fit the specific requirements and limitations of an embedded system. At the same time, a suitable embedded platform needs to be chosen to accommodate all the necessary computational structures of a neural network and to satisfy the power constraints to the application.

Short description of the project

The project aims to insert Artificial Intelligence specific methods into the automotive applications.

Implementation period

01.02.2020 - 31.07.2020

Budget

47.600 RON (10000 EUR)

Main activities

1. Identifying and studying the different types of deep neural networks: CNN-Convolutional Neural Networks, RNN-Recurrent Neural Networks, DBN-Deep Belief Networks
2. Choosing an appropriate development framework: Tensorflow (Keras), Caffe, Matlab
3. Developing an automotive specific application: traffic sign detection, pedestrian detection, drowsiness detection.
4. Studying the available embedded solutions and choosing the appropriate one.
5. Studying the computational limitations introduced by the hardware constraints.
6. Developing a deployment tool.
7. Testing and validating the results.

Results

1. Convolutional Neural Networks (CNN) and PointNet have been found to best fit automotive applications. These nets are also portable and can run on embedded systems.
2. Both Tensorflow and Keras are suitable for developing network architectures, training and testing the networks. MATLAB is also useful for preprocessing data.
3. Two automotive applications have been developed: traffic sign detection using CNN; driver hand gesture recognition using a 3D ToF (time of flight) camera and a 3D PointNet;
4. The best embedded system to run the applications was Google's Coral DevBoard, with TPU accelerator to efficiently run tensor operations.

Applicability and transferability of the results:

- The results are directly applicable in the automotive industry.
- Both the traffic sign recognition and hand gesture recognition applications improve driver-car interaction and so driving safety.

Research team

MIRSU Radu,
SIMION Georgiana,
POP-CALIMANU Ioana,
EROFEI Adrian Aliosa,
DRUTA Cristian Filip

Contact information

Assit. Prof. Radu MÎRȘU, PhD
Department of Applied Electronics
Address: Str. Vasile Parvan, No.2 Postal Code, Timisoara
Mobile: 0724317813
E-mail: radu.mirsu@upt.ro

MEASUREMENT OF EXPOSURE TO LOW FREQUENCY ELECTROMAGNETIC FIELDS NEAR HIGH VOLTAGE POWER INSTALLATIONS - EXCEM

Goal of the project

The main goal of this project is to obtain information on the actual values of the intensity of the electrical component and the induction of the magnetic component, related to the low frequency electromagnetic fields (1-300Hz, including harmonics) in the vicinity of medium or high voltage installations or equipment, in order to mitigate their effects. on human personnel or environment.

Short description of the project

Measurements are made in stations, near transformers, switches or other MV/HV equipment or lines.

Implementation period

01.02.2020 - 31.07.2020

Budget

47.600 RON (10000 EUR)

Main activities

- Main research activities are:
 - Purchase of measuring equipment and software.
- 1. Establish, together with the Plant Owner, the specific measurement procedures.
- 2. Performing field measurements.
- 3. Carrying out measurements in transformer stations and stations.
- 4. Making measurements on power lines.
- 5. Statistical processing of results.
- 6. Drawing up conclusions and recommendations.
- 7. Dissemination of research results.

The measurements concern the intensity of the electric field (kV / m) as well as the magnetic induction (T), carried out in accordance with Directive 2014/30/EU and other specific regulations.

Results

- According to a partnership with the National Power Grid Operator, Transelectrica most of our measuring activities were performed at the Fantanele, Iernut and Sibiu Sud Power Stations, belonging to the Sibiu Branch, as well as at some Timisoara Branch stations, around bus-bars, transformers, autotransformers, switchers, surge arresters, circuit breakers, at temperatures between 15 and 25 degrees Celsius, both for the Electric Field Intensity and Magnetic Field Induction.

- We can consider that all the recorded values are placed under the maximum 10 kV/m (1 mT) admissible level for permanent human exposure. or smaller than the maximum 20kV/m (3 mT) short time exposure limit. By taking in consideration all these facts, a lot of additional safety measures are not required or mandatory

Applicability and transferability of the results:

- The purpose of these measurements is an informal one, giving a real and objective image (by involving impartial academic staff), about the existing values. All data resulted from this project will be communicated exclusively to the owner of the objective generating MV/HV electromagnetic fields (ex. Transelectrica), together with a set of conclusions and recommendations of an informal character.

Research team

Assist. Dr. Mihaela FRIGURA-ILIASA
Assist. Dr. Felicia Ioana BALOI
Assist. Dr. Adrian Flavius OLARIU
PhD. Stud. Razvan Claudiu PETRENCI

Contact information

Assist. Prof. Mihaela FRIGURA-ILIASA, PhD
Faculty of Electrical and Power Engineering
Power Systems Department
2, V. Parvan Bvd., Timisoara 300223
Phone: (+40) 256 403415
Mobile: (+40) 744 631989
E-mail: mihaela.frigura@upt.ro

THE INFLUENCE OF PROCESS PARAMETERS ON PROPERTIES OF SAMPLES OBTAINED BY ADDITIVE MANUFACTURING

Goal of the project

The main goal of the project was to establish analytical correlations between the input process parameters and the outcome properties of samples obtained by selective laser sintering.

Short description of the project

The project approaches an exploratory research that fit in additive manufacturing field, particularly on Selective Laser Sintering (SLS). Using SLS technology, samples were manufactured under various conditions. By inspecting and mechanical testing, important findings in process parameter-property relation were identified.

Implementation period

01.02.2020 - 15.06.2020

Budget

47.600 RON (10000 EUR)

Main activities

- Geometric model design according to ISO 527-1:2012(en) and ASTM D 5045-14 standards.
- Sample manufacturing by SLS under rational selection of process parameters.
- Inspection of dimensional accuracy of samples and microstructure investigation.
- Mechanical testing: tensile, bending and fracture mechanics.
- Data analysis by statistical tests (Pearson's correlation, Covariance, ANOVA)
- Process parameters – geometric and mechanical properties relation.

Results

- One hundred Polyamide (PA2200) samples were manufactured using two process variables: Orientation angle (OA) and Energy density (ED).

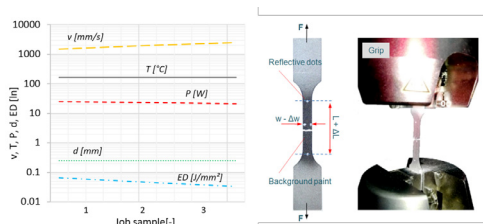

- Tensile tests on standard samples reveal the following behavior: energy density produces direct consequences on mechanical properties, an $ED < 0.06$ J/mm² leading to unacceptable strength values. The proper OA for the best tensile strength is 45° in X-Y plane.

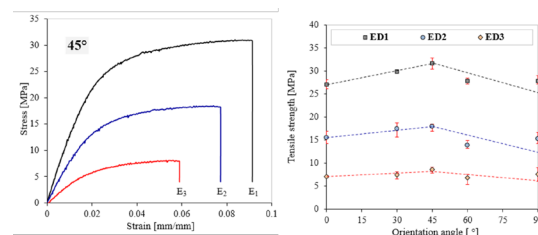

Identical process parameters were used to manufacture rectangular section samples. The 3P-bending tests were conducted on un-notch and notched samples in order to underline the bending strength and fracture toughness.

The geometrical results on these samples reveal a high dimensional error (up to 9%) on vertical direction (Z axis). Also, on this direction of growing the best density was recorded.

Pearson's correlation reveals strong positive relationship of density and KIC with ED and OA. The best fracture toughness value was determined for vertical orientation (Y-Z plane) and for highest ED, as the above diagrams indicate.

Applicability and transferability of the results:

The research results are addressed to manufacturing engineering field and they provide important information on how the process parameters are influencing the mechanical and geometrical properties of the parts. Relying on this information, the SLS process parameters can be set to obtain reliable results. Also, design restrictions for additive manufacturing process and samples virtual arrangement in the building envelope can be specified based on research data.

Research team

STOIA Dan Ioan,
MARŞAVINA Liviu,

ŞTEFAN Călin,
VIGARU Cosmina,

RUSU Lucian

Contact information

Assoc. Prof. Dan Ioan STOIA, PhD
Faculty of Mechanical Engineering
Mechanics and Strength of Materials Department
Address: Str. Mihai Viteazul, No. 1, 300222, Timisoara
Phone: (+40) 256 403633
Mobile: (+40) 722512247
E-mail: dan.stoia@upt.ro

MITIGATION OF PRESSURE PULSATIONS FROM THE CONICAL DIFFUSER USING THE PULSATING JET DEVICE

Goal of the project

The aim of this project is to focus on the influence of the pulsating jet on the dynamic and energetic performances of the conical diffuser, when the hydraulic turbines operate on a wide range of regimes. Thus the purpose of the initiative is: the safe extension of the operating regime of turbines or pump-turbines, by reducing or eliminating the self-induced non-stationarity of the flow with rotation, with the associated effects - noise, vibration, mechanical and dynamic loads. The project does not necessarily address the method itself, but rather its fundamentals, for a better understanding of the mechanism and effects of the pulsating water jet, in turbines and turbine pumps.

Short description of the project

The fundamental problem to which this project is addressed is the study at several operating regimes of a new method of controlling the decelerated swirling flow, with helical swirl. The new method consists of axial injection of a pulsating water jet along the axis of the suction tube of the hydraulic turbines, in order to reduce the pressure oscillations due to the swirling flow that appears at operating regimes far from the optimum one.

Implementation period

01.02.2020 – 15.06.2020

Budget

47.600 RON (10000 EUR)

Main activities

- O1. Experimental investigations with and without pulsating jet.
 - A.1.1. Implementation of the variable speed system, for obtaining different operating regimes of rotational flow
 - A.1.2. Testing the pulsed jet method at 5 operating modes
- O2. 3D numerical analysis of the swirling flow at different operating regimes with and without a pulsating jet
 - A.2.1. 3D numerical analysis at 5 operating modes with pulsed jet
 - A.2.2. Comparison of numerical data with experimental data.

Results

Thus, during the first phase of the project, the numerical analysis of the 3D flow at different operating points of the turbine was analyzed, with and without the technique of water injection with pulsating jet. The numerical analysis was performed using the FLEUNT expert software from ANSYS 16.2. The qualitative images of the velocity field below, obtained from the numerical simulation, show clearly that, with the introduction of the pulsating water jet along the axis of the conical diffuser, the helical vortex disappears, including the pressure pulsations associated with it, which damages the turbine.

- All the results can be found published in articles:
- C. TANASA, A. Bosioc, A. Stuparu and R. Susan-Resiga, "Numerical Analysis of Pulsating Water Jet Method in a Conical Diffuser at Different Operating Regimes", CIEM 2019, published IEEE.

- C. TANASA Adrian STUPARU, Catalin STROITA, Constantin POPESCU and Romeo SUSAN-RESIGA, (2019), 3D Numerical Analysis of Pulsating Water Jet in the Draft Tube Cone of Hydraulic Machinery, ICCMSE, Rhodes, Greece, AIP conference Proceedings, 2186.
- A. Bosioc, C. Tanasa*, 2020, Experimental study of swirling flow from conical diffusers using the water jet control method, Renewable Energy, 152, p.385-398. <https://doi.org/10.1016/j.renene.2020.01.08>
- C. Tanasa, A. Bosioc, S. Muntean, R. Susan-Resiga, 2019, A Novel Passive Method to Control the Swirling Flow with Vortex Rope from the Conical Diffuser of Hydraulic Turbines with Fixed Blades, Appl.Scienc., 9 (4910).

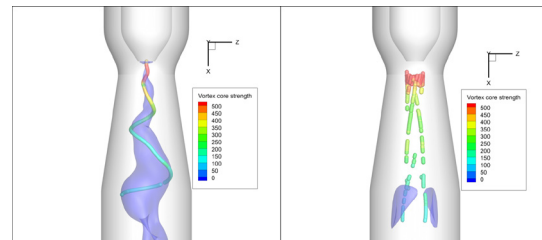

Applicability and transferability of the results:

The method to be tested on the experimental stand will be proposed for use on real hydroelectric power plants from the national electricity company SC Hidroelectrica SA Romania, which is a partner of UPT in different contracts in the field of hydraulic machines.

Research team

Constantin TANASA, Adrian STUPARU, Daniel STROITA, Constantin POPESCU

Contact information

Assist. Constantin TANASA, PhD
ICER – Research Institute for Renewable Energies
Address: Str. Piata Victoriei, No. 2 Postal Code 300006, Timisoara
E-mail: constantin.tanasa@upt.ro

ORGANIZATIONAL CAPACITY ASSESSMENT FOR SUSTAINABLE DEVELOPMENT IN THE CONTEXT OF CIRCULAR ECONOMY (ECOSEC)

Goal of the project

The project aims to develop a web platform that integrates a tool for organizational evaluation and to provide a laboratory with evaluation equipment. The tool contributes to diagnosing the capacity of organizations for sustainable development, elaborates a personalized strategic plan of action to respect the principles of the circular economy and develops a manual for self-training that contributes to the improvement of the current situation.

Short description of the project

The project integrates sustainability and circular economy in order to develop an evaluation tool.

Implementation period

01.02.2020 - 31.07.2020

Budget

47.600 RON (10000 EUR)

Main activities

The main activities are:

- Organizing knowledge for sustainability and circular economy
- Development of the tool for organizational evaluation
- Equipping a laboratory called EcosEc
- Dissemination of results in prestigious journals and scientific events.
- The elements of originality that the project brings are:
 - the diagnosis made in an integrated way by considering GRI indicators and standards
 - generates for each organization a strategic action plan to correct the deficient activities
 - a manual for self-training, personalized, according to the degree of maturity
 - creates a laboratory for organizational evaluation on sustainable development, provided with equipment and 5 trained evaluators.

Results

The results of the project are:

- Project identification through promotional materials
- Development and equipment of the laboratory called EcosEc (1 projector, 10 tablets, 2 laptops, 1 mini-library, teaching materials from recycled paper)
- Meetings with companies to identify indicators for evaluation
- Development knowledge maps to identify the organizational profile
- Publication of a manual for organizational self-training after evaluation

- Identifying the profiles and needs of businesses and economic opportunities
- Promotion of the evaluation tool in the business environment (over 9 appearances)
- Publication of 18 articles:
 - 3 articles in journals with quartile Q2, Q3 and WOS
 - 9 articles at WOS indexed conferences
 - 6 articles in BDI indexed journals
- Training of 5 trainers
- Training of more than 20 masters



Applicability and transferability of the results:

The project is based on the development of a tool for assessing the sustainability and deficiencies that can be applied in different companies.

- The developed tool can be used on companies from different fields of activity. It can be customized for other areas of activity.
- The instrument is used in laboratories of the faculty. It can be used by other fields of study.

Research team

IVAȘCU Victoria-Larisa

ARTENE Alin-Emanuel

TURI Attila

GĂUREANU Alin

DUFOUR Corina Monica

Contact information

Assoc. Prof. Larisa IVAȘCU, Ph.D.

Faculty of Management in Production and Transportation

Department of Management

14 Remus Street, 300191, Timișoara

Phone: (+40) 256 404307

E-mail: larisa.ivascu@upt.ro

Web: http://www.mpt.upt.ro/eng/research/pdf/CCIM/CV_lvascu%20Larisa_eng.pdf

QUALITATIVE STUDY OF EVOLUTION EQUATIONS AND APPLICATIONS TO DYNAMICAL SYSTEMS

Goal of the project

The main goal of the project is to characterize the nonuniform behavior for evolution equations in infinite-dimensional spaces and to apply the theoretical results in the study of a class of Euler equations.

Short description of the project

We characterize nonuniform (exponential) stability and nonuniform dichotomy in terms of evolution semigroup and admissibility method.

Implementation period

01.02.2020 - 15.06.2020

Budget

47.600 RON (10000 EUR)

Main activities

The research team was focus on the following activities:

- Definition of the evolution semigroup in the context of nonuniform behavior and characterization of nonuniform exponential stability in terms of invertibility of the corresponding infinitesimal generator.
- For an arbitrary noninvertible evolution family and for a large class of rate functions, we characterize to notion of general dichotomy in terms of two admissibility conditions. As a nontrivial application of our work, we establish the robustness of general dichotomies.
- Study of the local well-posedness in the smooth category for a class of Euler–Arnold equations.

Results

The main results of the project were published in:

- N. Lupa, L.H. Popescu, Admissible Banach function spaces and nonuniform stabilities, accepted in Mediterranean Journal of Mathematics (ISI journal, IF 1.181)
- E.C. Cismas, N. Lupa, A Nash–Moser approach for the Euler–Arnold equations, Monatshefte für Mathematik, DOI 10.1007/s00605-019-01344-z, 2019 (ISI journal, IF 0.807)
- D. Dragičević, N. Jurčević Peček, N. Lupa, Admissibility and general dichotomies for evolution families, submitted to Asymptotic Analysis (ISI journal, IF 0.808)

Applicability and transferability of the results:

By allowing growth rates that are not exponential, we are considered situations where the Lyapunov exponents can be zero, and since we do not need to assume the invertibility of the evolution families on the whole Banach space, our results can be applied to a large class of dynamical systems, in particular to equations defined by compact operators on infinite-dimensional spaces.

Research team

Nicolae LUPA
Emanuel Ciprian CISMAȘ
Alexandra Raluca PEPELAN

Contact information

Assoc. Prof. Nicolae LUPA, PhD
Department of Mathematics
Politehnica University of Timișoara
Address: Piața Victoriei 2, 300006 Timișoara
Phone: (+40) 256 403 098
E-mail: nicolae.lupa@upt.ro

DESIGN OF A MODULAR MECHATRONIC DEMONSTRATOR WITH VIDEO FEEDBACK FOR CONTROL ALGORITHMS OPTIMIZATION

Goal of the project

The starting point of this research project is the insight that a human does not have a kinematic model of his arms, but still executes manipulation tasks efficiently in unstructured spaces, compared to the classic approach on robotic manipulation where a model of the arm must exist. The goal of our project is to explore the human-like manipulation, where the control system does not have a model of the arm, but relies on vision and machine learning.

Short description of the project

The project aims at using video feedback and machine learning for robotic manipulation

Implementation period

01.02.2020 - 31.07.2020

Budget

47.600 RON (10000 EUR)

Main activities

The main activities in the project are:

- Development of the Mechatronic structures to be controlled
- Development of the control algorithms
- Testing
- Publishing of results in Proceedings and Journals
- Participation at Conferences
- Participation at Workshops
- Construct the project website:
- <https://arut-mecatronic.weebly.com>
- Project Management

Results

- To achieve our goal, we designed a modular structure to accommodate various types of manipulators (serial, parallel), and with the help of an overlooking video camera, to control the system.

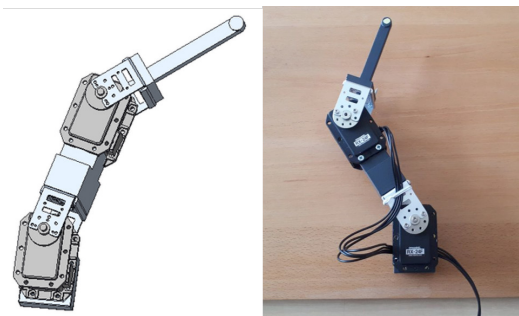

In the above figure is presented an example of a mechatronic structure to be controlled.

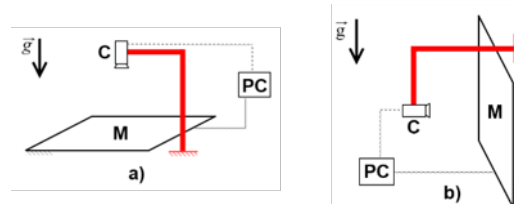

Figure a) and b) show the general system setup which incorporates the Mechatronic system, video camera and controller PC.

Along the constructed system, experimental results were published in ISI Web of Science.

The main result of the project is the construction of a test-bed for various mechatronic structures and control algorithms that is available in the Mechatronics Department to any researcher interested in this type of research.

The research areas of the project are: robotics, mechatronic design, algorithm design and development, machine vision, machine learning and artificial intelligence.

Applicability and transferability of the results:

The research is still in its infancy, there are only a few papers globally that tackle this approach. The proposed strategies apply especially in unstructured environments where manipulation is required.

Research team

Cristian MOLDOVAN
Valentin CIUPE
Nicolae TODEA

Contact information

Assist. Prof. Cristian Moldovan, PhD
Mechanical Engineering Faculty, Mechatronics Department
Address: Bv. Mihai Viteazu, No.1
Postal Code 300006, Timisoara
Phone: (+40) 256 403 554
Mobile: 0040 744 575 840
E-mail: cristian.moldovan@upt.ro
Web: <https://mctr.mec.upt.ro/personal/cristi-moldovan/>

DESIGN OF MULTIFUNCTIONAL PLATFORM BASED ON NANOCOMPOSITES FOR ENVIRONMENTAL AND SENSING APPLICATIONS (NANOPLAT-SENV)

Goal of the project

The NANOPLAT-SENV project scope is to develop new bifunctional composite materials characterized through perovskite structure for the sensing applications and advanced water treatment technologies. These materials will enable to detect electrochemically the cytostatics in water and also, to develop photocatalytic treatment processes for emerging pollutants-containing water treatment.

Short description of the project

A new and economic method for in situ obtaining of multifunctional nanocomposites was developed.

Implementation period

01.02.2020 - 15.06.2020

Budget

47.600 RON (10000 EUR)

Main activities

The main work packages and tasks are:

1. Project management;
2. Obtaining of new composites based on perovskite-type oxides;
3. Characterization of nanomaterials with perovskite structure on carbon support;
4. Evaluation of adsorption and photocatalysis capacity of the composite materials selected for cytostatics removal/degradation and correlation with the physico-chemical characterization;
5. Evaluation of electroanalytical activity of the selected composite materials for the elaboration of a method for electrochemical detection of the cytostatics from water;
6. Dissemination of the results.

Results

Lots of nanomaterials: LaFeO₃, LaCoO₃, CuCo₂O₄, CdCr₂O₄, CuBi₂O₄
Detection of CCB using LaFeO₃/BDD electrode

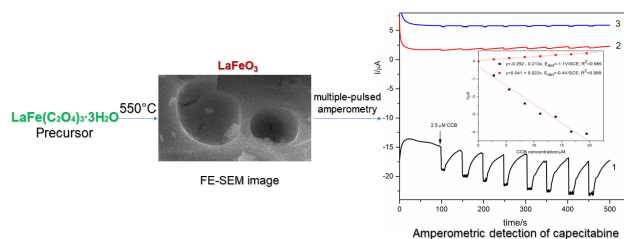

Applicability and transferability of the results:

The obtained nanocomposites were used for:

- development of sensors characterized by enhanced electroanalytical performance for cytostatics detection (e.g., doxorubicin, capcitabine, etc.);
- integration of VIS-based photocatalysis as advanced water treatment process related to the removal of cytostatics from water.

Research team

Raluca VODĂ
Florica MANEA
Aniela POP
Alin GOLBAN

Contact information

Assist. Raluca VODĂ, PhD
Faculty of Industrial Chemistry and Environmental Engineering
Department of Applied Chemistry and Engineering of Inorganic Compounds and Environment
Address: V. Parvan Sq. no. 6, 300223, Timisoara
Phone: (+40) 256 404 188
Mobile: +40740785104
E-mail: raluca.voda@upt.ro

CULTURAL AND PROFESSIONAL VALUES OF STUDENTS IN ROMANIAN TECHNICAL UNIVERSITIES

Goal of the project

The research aims to outline the iGeneration (iGen) profile – namely the profile of student population of Romanian technical universities – from the perspective of their values, of the way they perceive, learn, validate and use the media culture, as well as of their personal and professional expectations under the influence of the media culture

Short description of the project

Identifying the values and expectations of the young generation aspiring to an engineering career in the digital society.

Implementation period

01.02.2020 – 31.07.2020

Budget

47.600 RON (10000 EUR)

Main activities

- Theoretical and empirical objectives:
 1. Identification of consumption routines of students at technical universities regarding the media culture (practices and platforms) from the point of view of the shared cultural, citizen and professional values
 2. Determining students' expectations regarding the labour market and their own vocational training
 3. Defining strategies for negotiating the meaning of media messages
 4. Outlining the socio-professional value profile of the (I-Gen) student at a Romanian technical university

Activities:

1. Designing the survey tools and applying them online
2. Visiting university centres for data collection
3. Creating a database
4. Disseminating the results by publishing articles and participating in national and international conferences

Results

- 2 questionnaires were created and applied online
- over 3600 questionnaires were completed in 5 technical universities
- a database with representative samples for each university was created
- the 6 scientific articles were published:

- 3 articles are included in the ISI database:
 - 2 in VIRTUAL LEARNING – VIRTUAL REALITY, ICVL 2019, Bucharest University Press, ISSN: 1844-8933, WOS: 000506084800053
 - 1 in the BRAIN-LUMEN JOURNAL, Broad Research in Artificial Intelligence and Neuroscience – vol.no.10 / issue no. 4/December 2019
- the team members participated in 5 international conferences:
 1. Professional Communication and Translation Studies Conference, 4-5 April 2019 Timișoara
 2. Scientific Methods in Academic Research and Teaching, 7th Edition, Bușteni & Sinaia, Romania, 3-5 May 2019
 3. The International Conference PR-Trend Cluj-Napoca, 19.09-21.09.2019
 4. The 14th International Conference on Virtual Learning, ICVL 2019, 25 -26.10.2019, Bucharest
 5. 6th SWS International Scientific Conference Social Sciences 2019 24.08 - 2.09.2019, Albena, Bulgaria

Applicability and transferability of the results:

The obtained results helped to establish connections between domains, so that they allow the Romanian technical universities to issue forecasts regarding the graduates' behaviour in relation to the media consumption and the labour market.

The publication of the research results will take into account ARUT's specificity in the Romanian educational landscape, paving the way for extensive research on the relationship among technical universities, labour market and digital revolution.

Research team

Liliana CISMARIU, Daniel-Liviu CIUREL, Mariana CERNICOVA-BUCĂ, Mugurel – Gabriel Dragomir, Vasile GHERHEȘ, Simona ȘIMON

Contact information

Assist. Prof. Liliana CISMARIU, PhD
Faculty of Communication Sciences
Department of Communication and Foreign Languages
Address: Str. Traian Lalescu 2a, 300223 Timișoara, România
Tel. 0040-256-404011
0040-256-404013
E-mail: liliana.cismariu@upt.ro

International Research Projects

PROJECTS SUPPORTED BY INTERNATIONAL PUBLIC FUNDS IMPLEMENTED BY UPT 2019

Field	Total number of projects	Number of projects presented
Earth science	2	-
Engineering science	10	6
Materials science	1	1
Mathematics	1	1
Social science	4	1
Total	18	9

EVOLUTION OF PROJECTS SUPPORTED BY INTERNATIONAL PUBLIC FUNDS IMPLEMENTED BY UPT 2015 - 2019

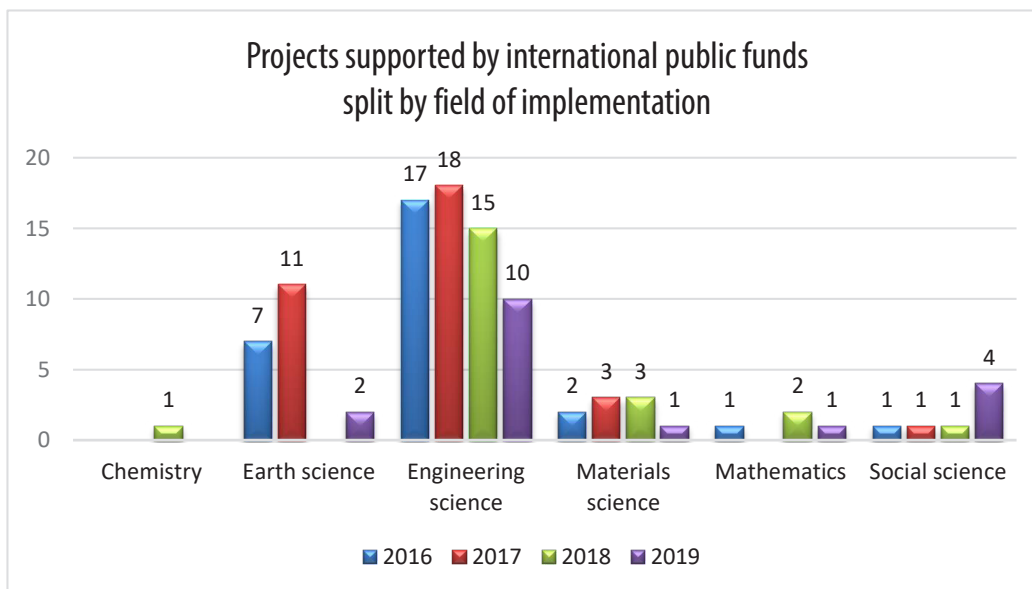
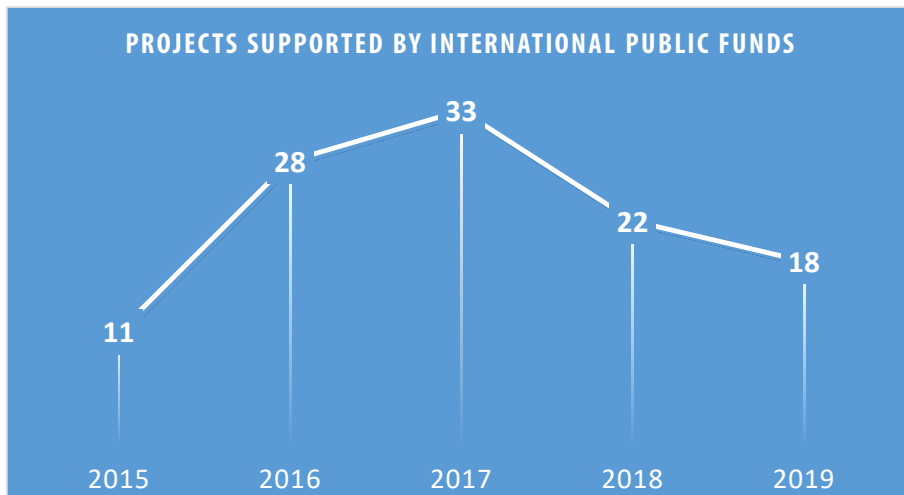

VALORISATION OF KNOWLEDGE FOR EUROPEAN PRE-QUALIFIED STEEL JOINTS

Goal of the project

The project aimed at valorization and extension of the seismic prequalification criteria of a set of steel beam-to-column joints by dissemination to a wide of academic institutions, engineers and architects, construction companies, and steel producers by producing informative documents, design guidelines and organizing seminars and workshops.

Short description of the project

The project developed design guidelines for seismically prequalified steel moment resisting beam-to-column.

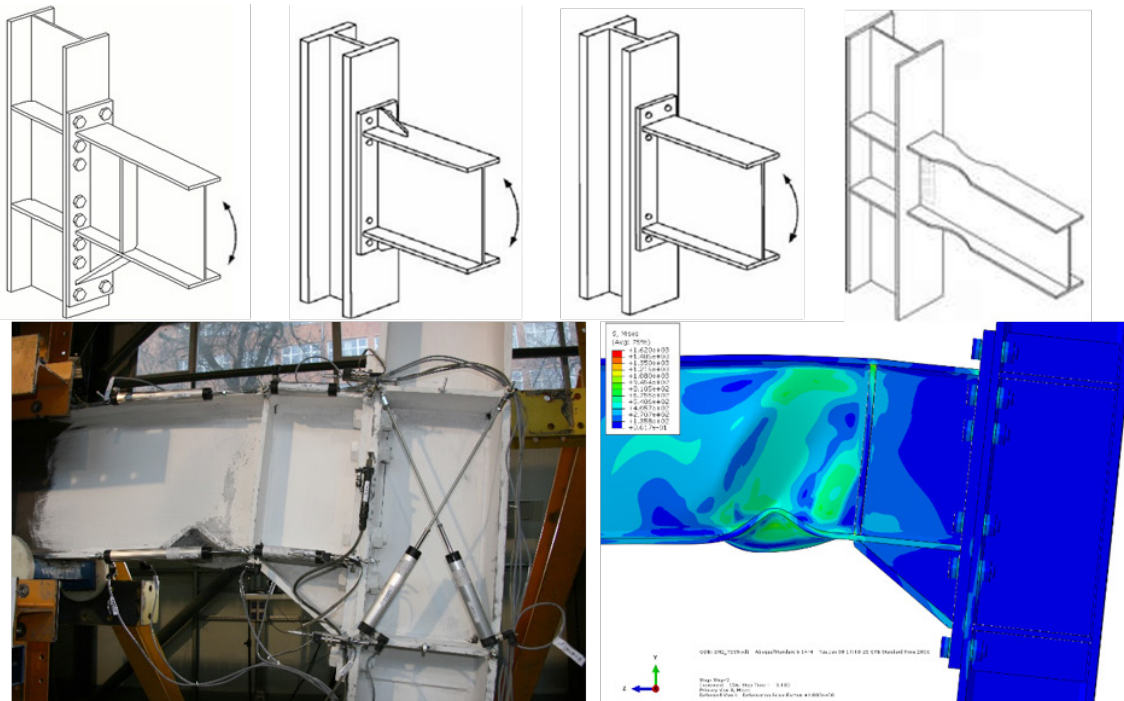

Implementation period

01.07.2017 – 30.06.2019

Project implemented by

UNIVERSITÀ DEGLI STUDI DI NAPOLI FEDERICO II (UNINA)
- coordinator
ARCELORMITTAL BELVAL & DIFFERDANGE SA (AMBD)
UNIVERSITÉ DE LIEGE (ULG)
POLITEHNICA UNIVERSITY TIMIȘOARA (UPT)
UNIVERSIDADE DE COIMBRA (UC)
EUROPEAN CONVENTION FOR CONSTRUCTIONAL STEELWORK (ECCS)
UNIVERSITÀ DEGLI STUDI DI SALERNO (UNISA)
IMPERIAL COLLEGE OF SCIENCE TECHNOLOGY AND MEDICINE (Imperial)

Centre Technique Industriel de la Construction Metallique (CTICM)
NATIONAL TECHNICAL UNIVERSITY OF ATHENS (NTUA)
CESKE VYSOKÉ UCENI TECHNICE V PRAZE (CVUT)
TECHNISCHE UNIVERSITEIT DELFT (TU Delft)
UNIVERZA V LJUBLJANI (UL)
UNIVERSITET PO ARCHITEKTURA STROITELSTVO I GEODEZIJA (UASG)
UNIVERSITAT POLITECNICA DE CATALUNYA (UPC)
RHEINISCH-WESTFAELISCHE TECHNISCHE HOCHSCHULE AACHEN (RWTH AACHEN)

Main activities

- Development of informative documents for the 4 beam-to-column joints qualified within the EQUALJOINTS project and translation of these documents from English to 11 additional languages
- Development of recommendations and criteria to be used in setting up limits of applicability between EN 1993:1-8 and EN 1998-1. A set of requirements within EN 1090-2 were defined. The documents were drafted as pre-normative design recommendation in English which were translated 11 additional languages
- Development of guidelines for design and analysis of seismic resistant steel structures accounting for the behaviour of beam-to-column joints. In addition, examples for different structural systems were presented which show the influence of different joint typologies.
- Enhancement of the EQUALJOINTS Matlab software for analytical prediction of the cyclic response of joints, allowing an easy application by users in practice. Moreover, an EQUALJOINTS-app for mobile phone was developed.
- Preparation of the material that was disseminated in English and translation in the mother tongue of the places where seminars/workshop were taken.
- Organization of 14 workshops and seminars where the pre-normative design guidelines were disseminated. In addition, the materials are available in printed forms and downloadable from the project website.

Results

The prequalification criteria for the 4 typologies of steel moment resisting beam-to-column joints from the EQUALJOINTS project (3 bolted connections and 1 reduced beam section – dog-bone) are being considered for the implementation in the next version of the European seismic design code. Informative documents and pre-normative design recommendations were developed, published and distributed during the project workshops, and downloadable from the project website (<https://www.steelconstruct.com/eu-projects/equaljoints/>).

Financed through/by

Research Fund for Coal and Steel, grant agreement RFCS 12/04/2017 – number 754048

Research Centre

The Research Centre for Mechanics of Materials and Structural Safety – CEMSIG



Applicability and transferability of the results

- Use of the new versions of design codes with simplified procedures for designing steel moment resisting beam-to-column joints.
- The rotational capacity and ductility demand of the joints required by the current codes are assured using the prequalification seismic design criteria.
- Increased structural safety against the seismic hazard in large parts of Europe.
- Improvement in life cycle costs and sustainability due to the reduction of losses caused by seismic hazards.

Research Team

- Acad. Dan DUBINA, PhD
- Assoc.prof. Aurel STRATAN, PhD
- Eng. Dominiq JAKAB
- Assist. Adriana CHESOAN, PhD

Contact information

Acad. Dan DUBINA
 Faculty of Civil Engineering
 Department of Steel Structures and Structural Mechanics,
 Ioan Curea Street No.1, 300224, Timișoara
 Phone: +40 (0) 256 403 911
 Mobile: +40 (0) 740 137 610
 E-mail: dan.dubina@upt.ro

PROVISIONS FOR GREATER REUSE OF STEEL STRUCTURES - PROGRESS

Goal of the project

The PROGRESS project will provide methodologies, tools and recommendations on reusing steel-based components from existing and planned buildings. The project particularly targets the design for deconstruction and reuse of envelopes, load-bearing frames, trusses and secondary elements of single-storey buildings framed in steel. This building type has broad applicability as industrial, commercial, sports, exhibition, warehouse facilities, and shows most potential in suitability for reuse and viability for circular economy business models. The whole life benefits of reusable single-storey steel buildings will be quantified from environmental and economic viewpoints. The outcomes will be extensively disseminated in particular among manufacturers, designers, contractors and researchers.



Short description of the project

The main objective of the proposal is to develop products, systems, methods and protocols that facilitate reuse of various components of steel-framed single-storey buildings. The proposed project addresses both deconstruction and reuse of existing buildings and how new buildings can be designed, constructed and documented to facilitate future reuse. Its scope includes: (a) primary structures (frames), (b) secondary structures, (c) envelope components and hybrid multi-material systems.

Project implemented by

VTT Technical Research Centre of Finland Ltd., (VTT, Finland)

Implementation period

01.07.2017-30.06.2020

Main activities

- review of the experiences from the successful reuse and deconstruction projects collected by the project partners and from the practitioners in the building industry;

Table 1. Reuse scenarios

	In-situ	Same site		Different site	
		Same configuration	Different configuration	Same configuration	Different configuration
Entire primary structure	A	B	C	D	E
Elements of the primary structure	N/A	N/A	F	N/A	G
Individual elements	N/A	N/A	H	N/A	I

- propose methods for the assessment of suitability of materials and elements for the reuse, including recommendations for their modification/adaptation to fit in the new design;
- propose technical recommendations for the increase of reusability of the components to be provided on component and building design levels.
- propose novel hybrid solutions for envelopes of single-storey buildings, either new buildings or renovation projects, that improves the thermal performance of the entire building, service life of envelopes and reusability of solutions themselves;
- propose a methodology to quantify and declare the environmental benefits of reused elements, resulting in recommendations on the circularity and LCA methodology;
- provide benchmark for demolition, classification and testing/verification protocols developed on a real deconstructed building including the laboratory tests to identify mechanical and chemical properties of the materials;
- design case studies to cover the most common reuse situations.

Results

- The outcomes of the project will include recommendations to:
- Reduce the technical barriers to reuse through establishing the quality verification procedures for the structural elements and envelopes of deconstructed low-rise buildings to be reused;
- Simplify the implementation of reusable components through recommendations for design for deconstruction and reuse, and for design using reclaimed elements as well as for safe and efficient deconstruction activities;
- Support the product manufacturers', facility owners' and designers' decision making by recommended methodology to calculate the environmental impact and cost of steel components reusing;
- Develop an online reused steel trading portal to co-ordinate the supply and demand for reused steel-based components;
- Develop novel types of hybrid solutions for envelopes in order to improve the thermal performance of a building, extend the service life of an envelope and maximize the reuse potential of components.

Applicability and transferability of the results

The majority of existing steel low-rise buildings can be deconstructed into elements such as cold-formed or hot-rolled sections, sheets, panels, frames or truss girders. These components have very high reuse potential, but require verification of the material quality, dimensions and tolerances in order to be included in new building projects. The future reuse of modern buildings, however, may be different, because those structures are increasingly designed as systems and their design information can be easily maintained for instance as a building information model (BIM).

Financed through/by

Research Fund for Coal and Steel, EU, grant agreement No 747847.

Research Centre

Research Center for Mechanics of Materials and Structural Safety (CEMSIG), Politehnica University Timișoara

Contact information

Acad. Dan DUBINA, PhD
 Faculty of Civil Engineering
 Department of Steel Structures and Structural Mechanics
 Phone: (+40) 256 403920
 Mobile: (+40) 740 137610
 E-mail: dan.dubina@upt.ro
 Web: www.ct.upt.ro

Prof. Viorel UNGUREANU, PhD
 Faculty of Civil Engineering
 Department of Steel Structures and Structural Mechanics
 Research Institute for Renewable Energy (ICER-TM)
 Address: Str. Ioan Curea, No. 1, 300224, Timișoara
 Phone: (+40) 256 403912
 Mobile: (+40) 740 137640
 E-mail: viorel.ungureanu@upt.ro
 Web: www.ct.upt.ro

NOVEL MODULAR STACK DESIGN FOR HIGH PRESSURE PEM WATER ELECTROLYZER TECHNOLOGY WITH WIDE OPERATION RANGE AND REDUCED COST (PRETZEL)

Goal of the project

Green hydrogen produced by electrolysis might become a key energy carrier for the implementation of renewable energy as a cross-sectional connection between the energy sector, industry and mobility. Proton exchange membrane electrolyzer (PEMEL) is the preferred technology for this purpose, still costs, efficiency, lifetime and operability need to be optimized. The aim of PRETZEL project is to develop a new PEMEL that provides significant improvements in efficiency and operability to satisfy emerging market requirements.

Short description of the project

The central objective of PRETZEL is to develop a new PEMEL for hydrogen production, upscaling a patented design approach based on hydraulic cell compression.

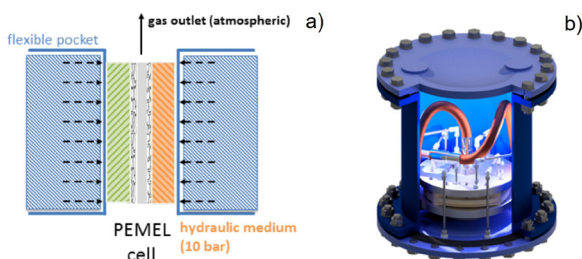

Principle of homogeneous hydraulic cell compression (a) and stack design for hydraulic compression (b).

The system will operate with a maximum energy consumption of 25 kWh, with a production capacity of 4.5 m³ H₂ / h at rated power, at a pressure of 100 bar and water temperature of 90°C. All subsystems needed to properly operate a PEMEL stack will be integrated in a housing, equipped with a hydrogen detection and ventilation system.

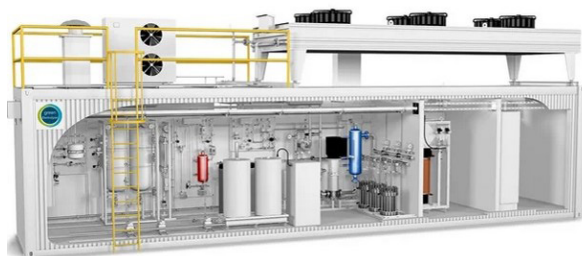

Schematic drawing of a PEMEL system as container solution by iGas energy.

Project implemented by:

Project Coordinator:

German Aerospace Center, Stuttgart, Germany (DLR)

EU Partners:

- Westphalian University of Applied Sciences, Germany (WHS)
- Association for Research and Development of Industrial Methods and Processes, France (ARMINES)
- Politehnica University Timișoara, Romania (UPT)
- Adamant Composites Ltd., Greece
- GKN Sinter Metals Engineering GmbH, Germany (GKN)
- Centre for Research and Technology Hellas, Greece (CERTH)
- Soluciones Catalíticas IBERCAT, Spain
- iGas energy GmbH, Germany

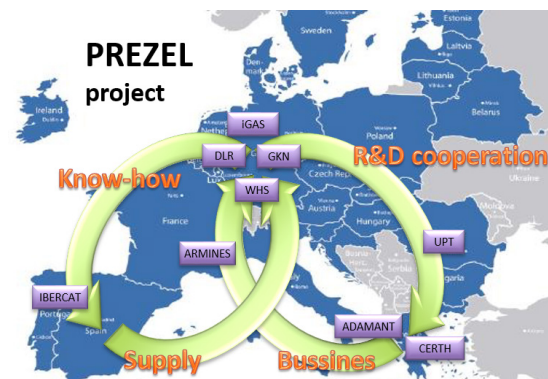

"PRETZEL"-like shape passing over the geographical location of all PRETZEL partners representing the long-term collaboration in know-how, supply chain, business partnership and R&D.

Implementation period

01.01.2018 – 31.12.2020

Main activities

UPT's main activities in PRETZEL are the investigation of newly developed bipolar plates (BPP), as cost-efficient alternative for the classical titanium BPP, consisting of highly corrosion resistant Nb-coatings deposited by vacuum plasma spraying (VPS) on copper pole plates in regard of:

- **Corrosion resistance** evaluation in simulated PEMEL environment, at 90°C and O₂ saturated solution, including accelerated stress tests at constant potential of 2 V applied for 6 hours
- **Interfacial contact resistance (ICR)** versus compaction force measurement
- **Structure and morphology** of BPP before and after accelerated stress tests

Results

- A 30 µm thick Nb coating fully protects the copper substrate against corrosion in simulated PEMEL environment, showing excellent corrosion resistance properties, with i_{corr} lower than 0.1 µA cm⁻².
- Cross-section images show no signs of corrosion, nor the formation of pinholes beneath the coating.

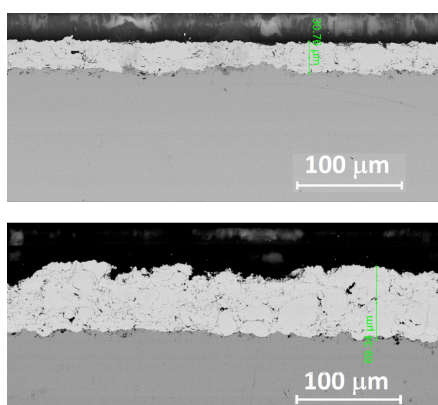

Cross section FE-SEM images of Nb-coatings after accelerated stress test.

- ICR decreases with compaction force up to 45 mΩ cm². In the range of 120 to 200 N cm⁻², which is the common pressure applied for assembling commercial PEM electrolyzer stacks, ICR decreases from 130 to 90 mΩ cm².

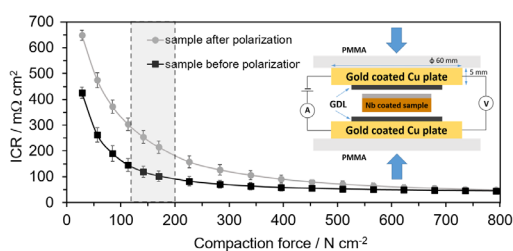

Interfacial contact resistance at different compaction forces.

Applicability and transferability of the results:

- **System:** Development and validation of a 25 kW PEM electrolyzer system with hydrogen output pressure of 100 bars or higher.
- **Cell components:** Reduction of Ir catalyst loading compared to the state-of-the-art, by the use of new aerogel supports.
- **Protocols:** development of complete protocols for BPP testing, including stress test, corrosion resistance and ICR.

Financed through/by

Fuel Cell and Hydrogen 2 Joint Undertaking under the European Union's Horizon 2020 research and innovation programme under grant agreement No 779478.

Research Centre

Research Institute for Renewable Energy (ICER-TM), UPT

Research team

Assoc. Prof. Andrea KELLENBERGER, PhD
 Prof. Nicolae VASZILCSIN, PhD
 Assoc. Prof. Narcis DUTEANU, PhD
 Assist. Prof. Mircea Laurentiu DAN, PhD
 Prof. Adina NEGREA, PhD
 M.Sc.Eng. Delia DUCA,
 Eng. Anuta SERAC

Contact information

Prof. Andrea KELLENBERGER, PhD
 Faculty of Industrial Chemistry and Environmental Engineering
 Department of Applied Chemistry and Engineering of Inorganic Compounds and Environment
 Bd. V. Parvan, No. 6, 300223, Timisoara
 Phone: (+40) 256 404 178
 Mobile: (+40) 726 448 966
 E-mail: andrea.kellenberger@upt.ro
 Web: <http://pretzel-electrolyzer.eu/>

REDOUBT - RELIABLE FPGA DATAPATH DESIGN USING CONTROL TECHNIQUES, CONTRACT ESA - 4000123993/18/NL/CRS

Goal of the project

This project proposes a novel control theory inspired fault tolerant methodology for FPGA implementations of processing data-paths working in harsh radiation space environments. The proposed methodology will rely on adding control loops, which will detect and correct the radiation induced faults. We will consider the data-path processing component as a process, for which control components will be added in order to increase the fault tolerance.

The main objectives of this project are:

1. Development of the theoretical background for the control engineering inspired fault tolerant mechanism
2. FPGA implementation for the fault tolerant data-path with control feedback loops
3. Analysis of the proposed methodology in terms of cost and fault tolerance, and comparison with other approaches, such as triple modular redundancy (TMR), reduced precision replicas (RPR), or redundant residue number systems (RRNS).

The proposed technique will target arithmetic dominant applications, which include digital signal processing, robotic arm control, or graphic processing.

Short description of the project

We aim at providing a novel fault tolerant technique for FPGA based digital electronics used in space applications.

Project implemented by

Politehnica University Timișoara (UPT) -lead,
Universitatea Tehnică din Cluj-Napoca (UTCN)- project partner.

Implementation period

July 2018 - June 2019

Main activities

We will investigate the cost and fault tolerance characteristics of the proposed technique, determining the advantages and the pitfalls. Thus, we will provide the theoretical foundation, a proof-of-concept implementation, as well as guidelines and characteristics for the control based reliability enhancement technique.

The project requires the following four steps:

1. SFI for the target datapath circuit in order to characterize the fault behaviour - This step will require RTL model of the targeted arithmetic intensive circuit, as well as performing the SFI at RTL for the implemented circuit.
2. Analytical modelling for the faulty datapath circuits - This step involves determining the high level modelling of faults, and developing the model associated to the process with perturbations. This step will consist of Matlab simulations.
3. Theoretical controller design used for error correction - In this step, the feedback controller will be designed in order to attenuate and mitigate the perturbations within the process associated to the faulty arithmetic datapath. The controller will be developed in Matlab
4. FPGA implementation and SFI based validation - This step will comprise of the RTL model of the control enhanced fault tolerant circuit, and its evaluation in terms of cost (FPGA implementation cost) and fault tolerance (using SFI). Comparisons with TMR, RRNS and RPR will be performed.

Results

- We have developed a fault tolerant digital circuit methodology that uses correction feedback loops in order to mitigate the magnitude of errors in data processing circuits.
- The feedback loops implement a linear controller, while the correction process is performed during several iterations.
- The obtained results have indicated that significant cost savings with respect to conventional fault tolerant methodologies, such as TMR, can be obtained.

Applicability and transferability of the results

- The REDOUBT project has been finalized, with a novel methodology for fault tolerant circuit design, based on control engineering, being developed.

Financed through/by

Agenția Spațială Europeană (European Space Agency – ESA)

Research centre

Research Centre for Computers and Information Technology

Research team

Oana BONCALO (PI)

Alexandru AMARICAL

Zsofia LENDEK (PI)

Contact information

Assoc Prof. Oana BONCALO, PhD
Faculty of Automation and Computers
Department of Computer Science
Address: Vasile Pravan Blvd, No. 2, Room B522.
Phone: (+40) 256 403 264
E-mail: oana.boncalo@cs.upt.ro,
oana.boncalo@gmail.com

COMBINATORIAL DESIGN OF NOVEL BIPOLAR PLATE COATINGS FOR PROTON EXCHANGE MEMBRANE ELECTROLYZERS (CODE-PEM)- EEA-RO-NO-2018-0502

Goal of the project

The CoDe-PEM project aims to contribute towards the development of affordable PEM electrolysis systems with the development of lower cost coating materials for bipolar plates and sinters. In order to lower the costs, a reduction in use of expensive materials and the introduction of new low(er) cost materials are key elements. In addition, new materials should allow for fast and low-cost manufacturing processes, such as stamping of BPP flow structures.

Short description of the project

Via an interdisciplinary partnership, the project aims to integrate research groups with complementary experience in materials development and hydrogen technologies of groups from the Institute of Renewable Energy from Politehnica University Timisoara (UPT) with the research groups New Energy Solutions and Corrosion and tribology, both within the institute of industry in SINTEF, see below.

In order to reach the goals of the project, the challenges related to the plate cost, corrosion, interfacial contact resistance (ICR) of the MEA/sinter/BPP stack and the materials durability will be addressed. This will be achieved by identifying optimal material compositions that avoids rapid performance degradation due to the formation of electrically resistive surface oxides, and that prevents contamination by potential dissolved ions from corrosion of the substrate (metal) plates.

Project implemented by

Politehnica University Timisoara, Romania
SINTEF Trondheim, Norway

Implementation period

2019–2023

Main activities

- Preparation of a database with potential materials systems for substrate-coating couples to be used for the fabrication BPP.
- Installation and upgrade of the combinatorial exploration system in UPT. A state of the art system is planned to be developed in UPT to allow the manufacture of compositional spreads out of several targets and with the possibility to grade libraries thickness.

- Preparation of the ex- and in-situ experimental set-up at SINTEF, including the test cell with online ICR monitoring.
- Ex situ- characterized libraries that will provide the information needed to tune up the combinatorial system and to adjust the composition range for the experiments.
- Optimized coating will results following the combinatorial - exploration – tests - manufacture - test iterative sequence.
- Ex situ and in situ characterized BPP that will provide further functional information for the optimization process

Results

Finished design of electrolyzer test cell (left) Stainless steel BPP (right)

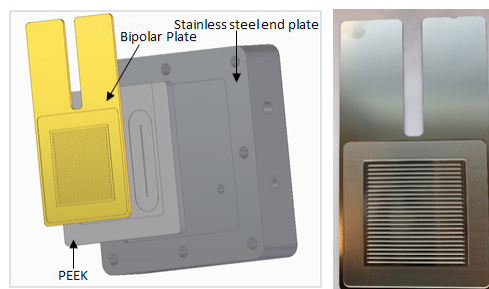

Different substrates with NiTiCu films deposited by magnetron sputtering (left) and the measurement of the film thickness (right)

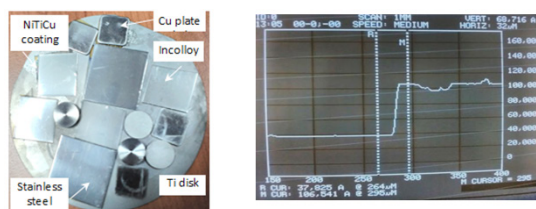

Linear polarization curves (Tafel plots) on (Ni-Ti)/Cu electrode in H₂SO₄ 10⁻³ M + 0.1 ppm F-1 at room temperature recorded at 1mV/s scan rate.

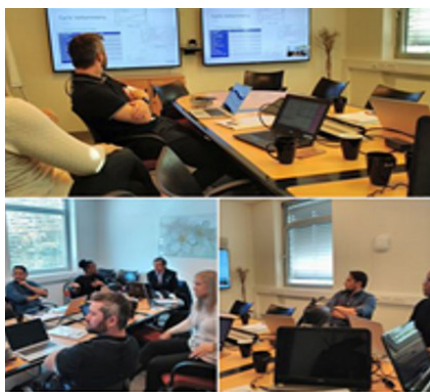
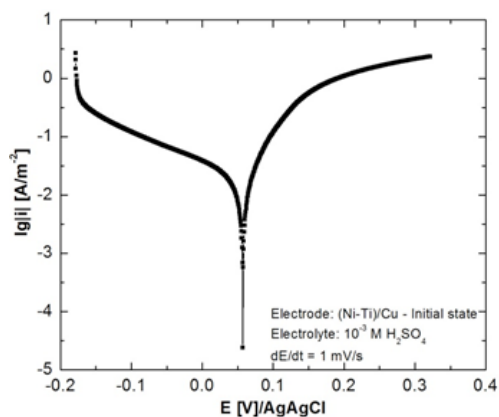

Partner's meeting in SINTEF

Applicability and transferability of the results

- The CoDe-PEM project will contribute to the Energy efficiency by focusing on identifying lower cost materials for electrolysers so that the cost of electrolyser systems can significantly be reduced.

Financed through/by

SEE Financial Mechanism (EEA Grants), 2014-2021

Research centre

Politehnica University Timisoara:
Combinatorial exploration group
Fuel cells group
SINTEF:
New energy solutions group
Corrosion and tribology group

Research team

Politehnica University Timisoara:
Prof. Corneliu M. Craciunescu
Prof. Nicolae Vaszilcsin
Prof. Mircea Dan
Prof. Ion Mitelea
Prof. Aurel Ercuta
Ph D. student Roxana Sprancenatu
Ph D. student Vlad Bolocan
Ph D. student Andrei Novac
Ph D. student Delia Duca
Ph D. student Mihaela Labosel

SINTEF Industry:
Senior Researcher Ødegård
Senior Researcher Dr. Sigrid Lædre
Senior Researcher Alejandro Oyarce
Senior Researcher Ole E. Kongstein
Engineer Ann-Karin Kvernbråten
Ph D. student Thulile Khoza

Contact information

Prof. Corneliu CRACIUNESCU, PhD
Faculty of Mechanical Engineering
Department of Materials and Manufacturing Engineering
Address: Bd. Mihai Viteazu , No. 1. 300026, Timisoara
Phone: (+40) 256 403 655
E-mail: corneliu.craciunescu@upt.ro
Web: <https://www.sintef.no/projectweb/codepem/>

EASTERN EUROPEAN TWINNING ON STRUCTURAL INTEGRITY AND RELIABILITY OF ADVANCED MATERIALS OBTAINED THROUGH ADDITIVE MANUFACTURING (SIRAMM)

Goal of the project

The overall objective of the SIRAMM project is to significantly strengthen research in the Additive Manufacturing (AM) field at the University Politehnica Timisoara. To achieve this aim, SIRAMM will build upon the existing science and innovation base of UPT, creating a network with two internationally-leading counterparts at EU level: Norwegian University of Science and Technology (Norway) and the University of Parma (Italy).

In the long term, the project aims at laying the foundations for creating a pole of excellence on AM in Eastern Europe. For this reason, other two partners from low R&I performing countries, the University of Belgrade (Serbia) and the Institute of Physics of Materials, Academy of Sciences (Czech Republic) also take part in this Twinning project.

Short description of the project

The project will be focused on the implementation of knowledge transfer activities such as workshops and staff exchange, training events (i.e. summer schools, seminars) for early stage researchers, and dissemination and communication actions (i.e. web site, videos, open access publications, public engagement activities) for different audiences.

To keep maintaining the knowledge transfer well beyond the duration of this project, a regular master course on AM technology will be also implemented in the coordinating institution.

Project implemented by

The project work plan has been structured into 5 Work Packages, which address all the key approaches and activities required for the successful achievement of SIRAMM's specific objective.

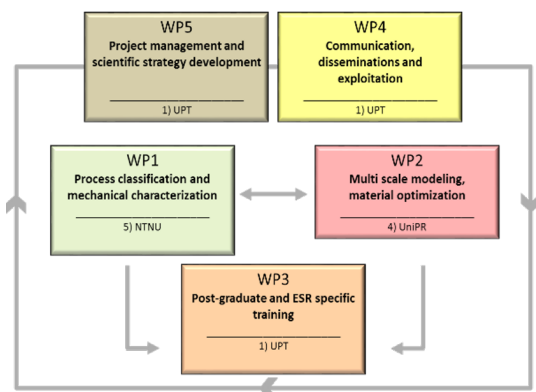

Implementation period

01.10.2019 – 30.09.2022

Main activities

- Staff exchange between partners
- PhD students exchange
- Seminars for students
- Seminars for companies
- Summer Schools
- Workshops
- International conferences

Results

- Increased research excellence of the coordinating institution and the other widening partners,
- Enhanced reputation, attractiveness and networking channels of the partners,
- Training and professional development of a new generation of scholars,
- Growth of industrial sector,
- Increasing awareness in the general public.

Applicability and transferability of the results

- The proposed novel methodology for integrity and durability will increase the quality assessment methodology of AM components used in automotive, aerospace, and biomedical sectors, due to the higher safety level obtainable and reduced production costs. In particular for the automotive industry, these advances in AM knowledge will create new opportunities in terms of innovative design, resulting in lighter and safer products, with estimated production costs 10-30% lower than the traditional methods.

The project received evidence of interest from Beam-IT, an additive manufacturing company having the biggest machine park in Europe and the corporate Continental, world leader in the mobility sector.



Kick-off meeting, Timișoara, 7-8.11.2019

Financed through/by

European Commission, H2020-WIDESPREAD-2018-03 (action: CSA) under the grant agreement No. 857124



Research team

1. Coordinator: University Politehnica Timisoara (UPT), Romania
2. Faculty of Mechanical Engineering, University of Belgrade (UBG), Serbia
3. Institute of Physics of Materials, Academy of Sciences of the Czech Republic (IPM), Czech Republic
4. University of Parma (UniPR), Italy
5. Norwegian Univ. of Science and Technology (NTNU), Norway



Research centre

"St. Nadasan" Research Laboratory for Strength, Integrity and Durability of materials, structures and conductors.

Contact information

Prof. Liviu MARSAVINA, PhD
Department Mechanics and Strength of Materials
Address: Blvd. M. Viteazu, No.1, 300222, Timisoara, Romania
Phone: (+40) 256 403577
Mobile: (+40) 726 397635
E-mail: liviu.marsavina@upt.ro
Web: <http://www.siramm.unipr.it/>

LINKING TRANSNATIONAL, MULTIMODAL TRAVELLER INFORMATION AND JOURNEY PLANNERS FOR ENVIRONMENTALLY-FRIENDLY MOBILITY IN THE DANUBE REGION

Goal of the project

There is a huge cross-border travel demand within the EU leading to hundred millions of cross-border trips every year by EU residents and further several hundred million trips by international tourists. More than 100 providers of traveller information services exist in Europe covering different levels, from local to regional, national and pan-European. The goal is to work on the inter-linking of existing services in order to enable transnational journey planning that goes beyond the territory covered by the single systems and offers travellers one seamless journey planning result.

Short description of the project

The objective is to develop a decentralised system architecture that enables distributed journey planning.

Project implemented by

An international consortium of journey planner- and transport operators in the frame of the INTERREG project "LinkingDanube" from Austria, Czech Republic, Hungary, Slovakia, Slovenia and Romania (with two partners, UPT and Electronic Solutions Ltd.)

Implementation period

01.01.2017 – 30.06.2019

Main activities

In particular the main objective is to develop a decentralised system architecture that enables distributed journey planning. By developing and establishing a common interface at each of the involved systems, the exchange of requests and results (not data) will be facilitated. The multiple responses of the involved systems have to be merged by means of an intelligent journey planner algorithm. The involved systems will engineer an application programming interface (open API) that allows bi-directional communication of the enquirer system (the system requesting information from other systems) and the responding systems. A common exchange specification will be developed that all participating systems will implement. Besides the method of implementing common gazetteers and exchange points within the distributed system will be one of the crucial points.

Results

The actual development work of LinkingDanube will be done both on national level in a decentralised adaption of the national journey planners as well as on central level in setting up a central entity. In the end this means that national services will be able to "plug into" a common interface and provide seamless information from multiple

systems to cross-border travellers. After implementation and testing, the technical feasibility will be demonstrated for the respective regions in relevant use cases.

The pilot action will demonstrate, test and validate the developed concept and demonstrate how integrated journey planning helps to connect citizens and commuters across borders and rural regions to major hubs. In this way the demonstrations will be the basis for further large-scale implementation.

Applicability and transferability of the results:

A central focus of LinkingDanube is the development of a concept for transnational multimodal journey planners in order to integrate the advantages of hub-to-hub-routing with local routing for cross-border regions and the elaboration of technical specifications for interface and data exchange. This concept shall build on existing structures in the partner countries, enhancing existing journey planners instead of creating a completely new structure and is completely transferable.

Financed through/by

Co-funded by the European Union through the Joint Secretariat of the Danube Transnational Programme

Research team

Assoc. Prof. Dumitru IANCULUI, PhD
Assist. Prof. Attila GÖNCZI, PhD
Assist. Prof. Sorin NANU, PhD
Assist. Prof. Octavian STEFAN, PhD.

Contact information

Assoc. Prof. Dumitru IANCULUI, PhD
Faculty of Mechanical Engineering
Department of Mechanical Machines, Equipment and Transportation
Address: Bv. Mihai Viteazu No.1, 300222, Timisoara
Phone: (+40) 256 404 294
Mobile: 0744 780 588
E-mail: dumitru.iancului@upt.ro
Web: <http://www.mec.upt.ro>

CONTRIBUTIONS TO CODIMENSION k BIFURCATIONS IN DYNAMICAL SYSTEMS THEORY

Goal of the project

The overall project objectives are to produce new knowledge in the area of codim k bifurcations for continuous and discrete (smooth and non-smooth) dynamical systems and provide training in this area of research to early stage researchers.

Short description of the project

The project achieves its objectives during secondments.

Project implemented by

1. Politehnica University Timișoara (Coordinator)
2. Autònoma University of Barcelona
3. Obuda University
4. West University of Timișoara
5. University of Craiova
6. Acmit GmbH, Austria
7. University North Caroline at Charlotte
8. Shanghai Jiao Tong University, China
9. University of Sao Paulo, Brazil

Implementation period

1 April 2018 – 31 March 2022

Main activities

1. Study degenerate Bautin bifurcations;
2. Study degenerate Hopf–Hopf bifurcations;
3. Study other codimension k bifurcations in continuous (smooth) systems;
4. Study other codimension k bifurcations in discrete (smooth) systems;
5. Study codim k bifurcations in non-smooth systems;
6. Study bifurcations in non-smooth systems with impacts.

Results

Published articles:

1. L. Barreira, J. Llibre, C. Valls. Bounded polynomial vector fields in \mathbb{R}^2 and \mathbb{R}^n . *J. Diff Equations*, 268, 4416–4422, 2020.
2. J. Llibre, R. Oliveira, C. Rodrigues. Limit cycles for two classes of control piecewise linear differential systems. *Sao Paulo J. Math. Sci.*, 1–17, 2020.
3. C. Rocsoreanu, M. Sterpu, Approximations of the heteroclinic orbits near a double-zero bifurcation, (*IJBC*), Vol. 29, No. 6 (2019) 1950074.

Financed through/by

Horizon2020–2017–RISE–777911, “Dynamics”

Research team

J. Llibre,
J. Torregrosa,
G. Tigan,
L. Kovacs,
T. Haidegger,
S. Mihalas,
D. Constantinescu,
S. Douglas,
R. Oliveira,
X. Zhang

Contact information

Assoc. Prof. Gheorghe TIGAN, PhD
Department of Mathematics,
Address: Pta Victoriei, No.2, 300006, Timișoara
Phone: (+40) 256 403098
E-mail: gheorghe.tigan@upt.ro
<http://www.gsd.uab.cat/dynamicsh2020>

ARCHITECTURAL STRATEGIES FOR ROMANIAN CHILDREN FROM ABROAD

Goal of the project

A special perspective is needed when we speak of this special category, of children at risk, where the architecture and programs created for them will have to go beyond their usual limits, being necessary to fulfill and the curative aspect, beneficial for the manifestation of their resilience.

This research aimed to study the main factors involved in trying to find the ideal formula that connects them with the Romanian culture, art and architecture, thus facilitating their reintegration in the case of returning to the country and at the same time to be able to create a spatial identity in a foreign country with which does not identify.

Short description of the project

Realizing a research on the Romanian children who live abroad in Veneto Region in order to discover their relationship with the Romanian architecture.

Project implemented by

- Faculty of Architecture and Urbanism, Politehnica Timisoara University
- „Istituto Romeno di Cultura e Ricerca Umanistica di Venezia”, obtained with the support of the Romanian state through the national scholarship program „Nicolae Iorga”.

Implementation period

13 January 2019- 13 October 2019

Main activities

This research focused on collecting data and information about the current situation of Romanian children living abroad, on how they perceive art, architecture and traditional architecture and were realized creative workshops that wanted to bring them closer to Romanian traditional art and architecture:

- 4 April 2019- «Micii Arhitecți» organized in partnership with the Faculty of Architecture and Urbanism, Politehnica Timișoara and the non-governmental association AlternativEd Lugoj.
- 24 June 2019- «Portul tradițional românesc » organized in partnership with the Faculty of Architecture and Urbanism, Politehnica Timișoara and the non-governmental association AlternativEd Lugoj.

It was also organized a masterclass-

- „L’eternità architettonica di una città storica e la modernità” - for the students from Politehnica University, Faculty of Architecture and Urbanism, organized by „Istituto Romeno di Cultura e Ricerca Umanistica di Venezia” in partnership with the Faculty of Architecture and Urbanism on the 19 September 2019.



Results

- Finding solutions and proposing new strategies for rehabilitation and reintegration of all these categories of children in risk situations requires an interdisciplinary analysis, not being able to talk about the elaboration of new architectural programs for these children without taking into account the psychological, social, economic and political. A solution with a particular problem requires a separate approach that is not one-way.
- This paper presents only the start of the final research. Further researches are needed in order to compare the results with the Romanian children raised in the country and also with the Romanian children raised in other European countries. After that the research results will be more strongly supported and will give a better perspective of what architectural strategies can be implemented in order to achieve the purpose goal.



L'ABITO TRADIZIONALE ROMENO
celebrato
all'Istituto Romeno di Cultura e Ricerca Umanistica di Venezia

Atelier educazionale coordinato dalla dott. Camelia Popescu (Associazione AlternativED) e dall'arch. Cristina-Maria Povian (UPT – Facoltà d'Architettura e Urbanismo dell'Università Politecnica di Timișoara)

L'evento si svolgerà nella Sala di Conferenze dell'Istituto Romeno di Cultura e Ricerca Umanistica di Venezia,
Lunedì, 24 giugno 2019, alle ore 15:00

Ingresso su invito.
Istituto Romeno di Cultura e Ricerca Umanistica
Palazzo Corner – Cannaregio 2214 – 30121 Venezia (VE)
Tel.: +39 041 52 42 309; Fax: +39 041 71 53 31;
E-mail: istorgia@tin.it
<http://www.icrro/venetia/>





"L'eternità" architettonica di una città storica e la modernità

MASTER CLASS
moderatore
Grigore Arbore Popescu
intervengono
Prof. Arch. Michele Amendolagine
Arch. Roberto D'Agostino

19 settembre 2019, alle ore 17:00
L'evento si svolgerà nella Sala di Conferenze dell'Istituto Romeno di Cultura e Ricerca Umanistica di Venezia

Ingresso su invito.
Istituto Romeno di Cultura e Ricerca Umanistica
Palazzo Corner – Cannaregio 2214 – 30121 Venezia (VE)
Tel.: +39 041 52 42 309; Fax: +39 041 71 53 31;
E-mail: istorgia@tin.it
<http://www.icrro/venetia/>

Applicability and transferability of the results

- These architectural strategies are trying to facilitate the reintegration of Romanian children already living in a foreign country in the case of returning home and at the same time to be able to create a spatial identity in a foreign country with which does not identify when they move there with their families.

Financed through/by

Ministry of National Education and Scientific Research
"Nicolae Iorga" postdoctoral research and training scholarships at the Romanian Institute of Humanistic Culture and Research in Venice.

Research centre

„Istituto Romeno di Cultura e Ricerca Umanistica di Venezia”.

Research team

- PhD Arch. Cristina Maria POVIAN

Contact information

Associate Prof. Cristina-Maria POVIAN, PhD Arch.
Faculty of Architecture and Urbanism
Address: Str.Traian Lalescu, No.2A Postal Code 300223, Timisoara
Mobile: 0040767795
E-mail: cristina.povian@upt.ro

PROJECTS SUPPORTED BY PRIVATE FUNDS

PROJECTS SUPPORTED BY PRIVATE FUNDS IMPLEMENTED BY UPT 2019

Field	Total number of projects	Number of projects presented
Environment	40	3
Exploration and exploitation of the earth	1	-
Transport, telecommunications and other infrastructures	28	1
Education	4	-
Energy	2	-
Industrial production and technology	55*	7**
Social and economic sciences	1	-
Technological and engineering sciences	3	-
Total	134	11

* *National Private Funds: 54 projects;*
International Private Funds: 1 project.

** *National Private Funds: 6 projects;*
International Private Funds: 1 project.

EVOLUTION OF PROJECTS SUPPORTED BY PRIVATE FUNDS CONTRACTED BY UPT 2015 - 2019

A series of inter-institutional collaborations have crucially influenced UPT's ranking classification exercise between 2015 and 2019.

Two main categories of institutional collaborations are to be noted: inter-university collaborations and collaborations with enterprises. Each of them has clearly established, mutually-shared objectives: mutual support, know-how transfer, and cooperation objectives for a common output.

UPT has always maintained a close relationship with the community, with the external environment, this relationship being its own reason to exist. Beyond the actual research and formal education, the research accomplished through technological transfer has been a constant concern for the University departments, faculties and management structures, which is reflected in the number of contracts with private companies.

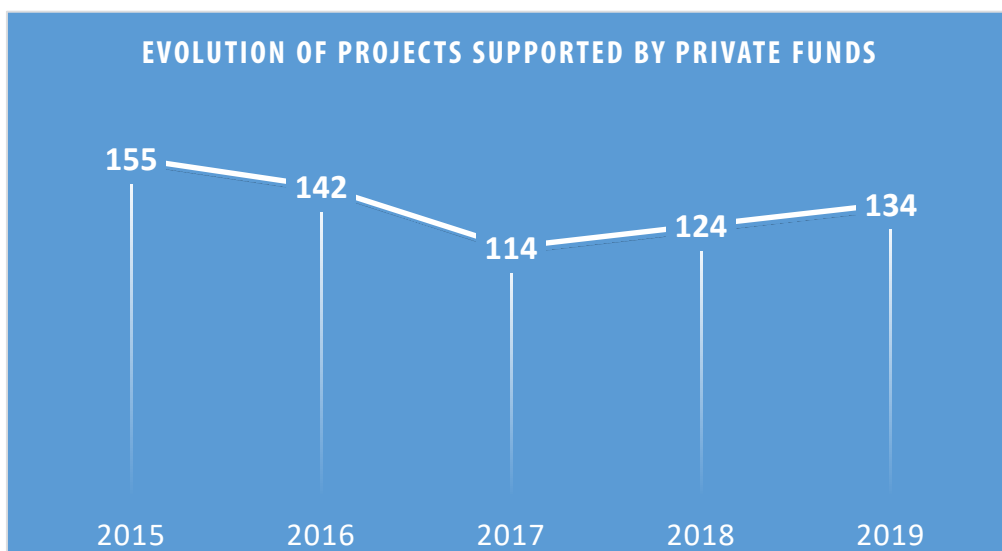

This chapter presents a selection of the research contracts with third parties.

RESEARCH IN THE DEVELOPMENT AND IMPROVEMENT OF AUTOMATED TESTING SYSTEMS USING LABVIEW, LABWINDOWS/CVI AND TESTSTAND

Goal of the project

Carrying out project execution services entitled "Research in the Development and Improvement of Automated Testing Systems using LabVIEW, LabWindows/CVI and TestStand". Technical consultancy activity in the field of automated testing systems.

Short description of the project

Design, development of automated testing systems.

Implementation period

15.03.2019 – 15.07.2019

Main activities

The following were achieved:

- automatic testing programs;
- programs, which were based on event scheduling;
- handling program errors;
- graphical interfaces for automatic testing programs of electronic circuits;
- programming of DAQmx type acquisition boards;
- programming of test equipment on different communication interfaces;
- distribution of the application by generating installation packages.

Results

- New programming techniques have been implemented for testing electronic circuits and programmable measurement and control equipment has been interfaced with computer systems.
- Threads have been implemented for automated testing programs and multi-core programming for testing systems has also been achieved.
- New automated testing techniques were used, such as: boundary scan, ICT and functional testing.

Applicability and transferability of the results

The results are used in the Honeywell Life Safety Romania S.R.L. plant from Lugoj, Timis country, Romania.

All the test systems and test programs are implemented and used for testing many electric circuits fabricated in the plant.

Research Centre

Programmable Logic Systems Research Laboratory supported by National Instruments & Honeywell Life Safety Romania S.R.L.

Financed through/by

Honeywell Life Safety Romania S.R.L.

Research team

Roland SZABO, PhD
Prof. Mihaela LASCU, PhD

Contact information

Roland SZABO, PhD
Faculty of Electronics Telecommunications and Information Technologies/Applied Electronics Department & Measurements and Optical Electronics Department, Address: Vasile Parvan Av., No. 2, Postal Code 300223, Timisoara
Phone: (+40) 256 403 351
E-mail: roland.szabo@upt.ro
Web: <https://sites.google.com/view/rolandszabo>

EXTENDING THE FLYING PROBE MEASUREMENT CAPABILITIES BY EXTERNAL LCR METER INTEGRATION

Goal of the project

The goal of this project was to implement a flexible solution to integrate, at software and hardware, level the Takaya Flying Probe (FP) type equipment and the LCR meter. By this solution, we aimed at extending the measurement range and improving the accuracy of the FP, in the process of evaluating circuit-mounted inductive and capacitive components.

Short description of the project

The goal of this application is to avoid the apparition of FP erroneous measurement results, for circuit-mounted L and C components, by integration of an LCR meter with the FP. This application was implemented with the help of a partner company which provided the required equipment: the Takaya APT 1400F FP and the BK Precision 891 LCR meter.

Implementation period

01.04.2019–31.12.2019

Main activities

- A study on the communication possibilities between the Takaya APT, LCR meter and external applications using Dynamic Data Exchange (DDE) technology;
- Automatic determination of the best conditions for measuring L-C components, by automatic analysis of the frequency response;
- Development of the integrated software for repetitive measurements;
- Testing experimental models in the industrial area to evaluate the repeatability and measurement accuracy of the proposed solution.

Results

- The integration of the LCR meter device can be performed transparently, without complex user intervention;
- A collection of VI functions, based on DDE, that provide communication between APT and an external device;
- Software for the automatic determination of the best measurement conditions by analyzing the response in the frequency range 1 kHz – 300 kHz;
- Software for automatic measurement of inductive and capacitive parameters;
- Part of the experimental results have been published in an ISI indexed Journal: R. Ionel, S. Mischie, D. Belega, L. Mătiu-Iovan, C. Dughir, I&M Applications for Educational Purposes, IEEE Instrumentation & Measurement Magazine, April, 2020.

Applicability and transferability of the results

With the redevelopment of the urban section of the watercourse, it is possible to exploit this non-polluting energy resource in order to satisfy a part of the public consumption. For the moment, the technical part of the study was disseminated through a scientific paper published in the specialized journal Hidraulica Bucharest (ISSN 1453–7303).

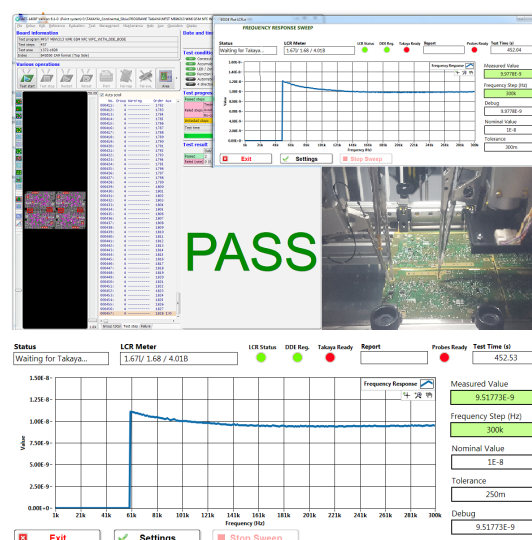

Financed through/by

S.C. Alfa Test S.R.L., Timișoara

Research team

Lecturer Liliana MĂȚIU-IOVA, PhD
Lecturer Raul Ciprian IONEL, PhD
Adina Elena IVONICIU

Contact information

Lecturer Eng. Liliana MĂȚIU-IOVAN, PhD
Faculty of Electronics, Telecommunications and Informational Technologies, Department of Measurements and Optical Electronics
Address: Room B329, 3rd Floor, Bd. Vasile Parvan, nr. 2, 300223 Timisoara, Romania
Phone: (+40) 256 403367 Mobile: (+40) 722307996
E-mail: liliana.matiu-iovan@upt.ro Web: meo.etc.upt.ro

RESEARCH ON ADVANCED INTEGRATION BETWEEN THE TERADYNE TSA N129 TEST STATION AND THE VECTOR CANCase XL DEVICE

Goal of the project

The goal of this project was to implement a functional technical approach related to an integration between the Vector CAN Case XL (CCXL) module and the Teradyne In Circuit Tester (ICT). The proposed application is the achievement of a collaboration between two industrial partners: Continental Automotive Romania (Timișoara Plant) and Alfa Test S.R.L. The need for such an integration has originated in the context of permanent focus on innovative production solutions.

Short description of the project

The capabilities offered by this solution include: communication protocol administration, automated formatting of CAN messages, CAN segmentation, selection information embedded in exchanged frames or the combination of ICT based measurements interposed between CAN dialogs.

Implementation period

01.04.2018 - 31.03.2019

Main activities

- Activity 1: A study on the communication possibilities between the Teradyne In Circuit Tester equipment and external hardware tools, using dedicated DLL files.
- Activity 2: Preliminary communication implementations between the Teradyne In Circuit Tester equipment and external hardware tools, using dedicated DLL files.
- Activity 3: Testing the communication library and extending the available commands set. The results should be a 90% minimal success rate for transferring the CAN frames between the Vector tools and the ICT software.

- The Teradyne Test Station Multi Site (1)
- Two CCXL network interfaces have been placed inside the back chassis; Test Fixture (2);
- DUTs (3);
- ICT monitors (4).



Financed through/by

S.C. Alfa Test S.R.L., Timișoara

Results

- over 130 CAN telegrams/responses and can be used for testing other products;
- average response time of 0.56s/CAN command (TS send cmd, TS receive rsp);
- Automated repetition in case of FAIL responses (3 times);
- First Pass Yield (FPY) = 98%, 51 consecutive runs, average test time is 97 s, over 320 CAN command/response exchanges for each test, experimental context;
- approximately 25000 DUTs/month tested with this solution;
- best FPY average over 2 months 96%, worst case FPY average over 2 months 79%. These results are a combined result, with pure ICT test;
- average test time/DUT is 107s.

Applicability and transferability of the results

The solution is running in production, it includes over 100 CAN telegrams/responses and can be used for testing other products. An average response time for a single CAN telegram, from the moment it is issued by the Teradyne Test Station until the user receives the result on the Test Station interface is approximately 0.56 s. A 2.22 s execution time has been obtained for a frequency measurement test which includes 3 type of CAN telegrams.

The proposed application has been developed in the context of creating innovative test solutions which correspond to the requirements of one of the most important automotive companies worldwide.

Research team

Assist. Prof. Raul Ciprian IONEL, PhD
Assist. Prof. Liliana MĂȚIU-IOVA, PhD

Contact information

Assist. Prof. Raul Ciprian IONEL, PhD
Faculty of Electronics, Telecommunications and Informational Technologies, Department of Measurements and Optical Electronics
Address: Room B326, 3rd Floor, Bd. Vasile Parvan, nr. 2, 300223 Timișoara, Romania
Phone: (+40) 256403366, Mobile: (+40) 723619912
E-mail: raul.ionel@upt.ro
Web: <https://ieeexplore.ieee.org/document/8583920>

TECHNICAL-SCIENTIFIC ANALYSIS REGARDING THE POSSIBILITY OF FUEL AND NOXES REDUCTION OF DIESEL ENGINES THAT EQUIPP S.C. SANGO WATER CO S.A. PERSONS TRANSPORT VEHICLES

Goal of the project

The aim of the project is to identify the technical solutions that can be implemented on a target group of vehicles in order to reduce the fuel consumption as well as the emissions exhausted during their operating regimes.

Short description of the project

Within the project, the fuel consumption of a group of vehicles was analyzed based on pollution standards and real operating conditions.

Implementation period

01.10.2019–24.05.2020

Project implemented by

The project will be implemented by S.C. Sango Water Co S.A.

Main activities

- Identification of real test conditions.
- Determining the fuel consumption for the buses in the target group.
- Measurement and verification of results.

Results

- The factors that lead to a reduction in fuel consumption at a target group of buses were identified
- Technical solutions for optimizing fuel consumption have been proposed.

Applicability and transferability of the results

- The obtained results led to the identification of technical solutions to reduce fuel consumption, and implicitly, the pollution degree, so that the emission values to fall within the limits imposed by pollution standards.

Financed through/by

S.C. SANGO WATER Co S.A.

Research Centre

Research Centre for Thermal Machines and Equipments, Transportation and Environmental Pollution Control,

Research team

- Daniel OSTOIA,
- Arina Negoitescu,
- Adriana Tokar,
- Dan Negoitescu,
- Ion Silviu Borozan,
- Dan Tokar

Contact information

Prof. Daniel OSTOIA, PhD
Faculty for Mechanical Engineering
Research Centre for Thermal Machines and Equipments,
Transportation and Environmental Pollution Control,
Address: Mihai Viteazu No. 1, Postal Code 30222, Timisoara, Romania
Phone: (+40) 256 403672
Mobile: (+40) 722827957
E-mail: daniel.ostoia@upt.ro

POLLUTANT EMISSION MONITORING OF DIFFERENT INDUSTRIAL EQUIPMENTS & TECHNOLOGICAL UNITS, ACCORDING CONTRACTS WITH DIVERSE ECONOMIC AGENTS, BASED ON THE RENAR ACREDITATION OF THE LACIEDIN LAB OF UPT

Goal of the project

- Goal of all cooperation contracts is to identify the ecological performances of different technological processes and units, based on emission monitoring of species such as: NO_x, CO, SO₂, particles, VOC, CO₂, in addition O₂ and physical parameters control.
- The LACIEDIN laboratory, as unique university laboratory for air quality monitoring in the region, offers support to detect potential polluting sources and elaborates diverse technical bulletins, according the measurements.
- Main clients of our lab are indicated in the followings: SC CENTRALA ELECTRICA DE TERMOFICARE HIDROCARBURI S.A. ARAD; COMBINATUL AGROINDUSTRIAL OLARI; SPUMOTIM S.A. TIMISOARA; FRIGOGLASS SRL PARTA, SC ELBA SA TIMISOARA, SC PORKPROD IRATOSU, CASADEVALL ROMANIA SRL, VOESTALPINE ROTEC COATING SRL, UTTIMISOARA, PLASESS ROMANIA SRL CHISODA, KIMBALL ELECTRONICS ROMANIA SRL REMETEA MARE, SMART WOOD ROMANIA SRL TIMISOARA, and others.
- One expresses respect & appreciation for all industrial partners, and thank for the opportunity to serve their interest.

Short description of the project

TESTS: 1. Specific tests for identification of the concentration of specific gaseous and solid pollutants, according legislation and standard methods,

2. Physical tests.

SCOPE: 1. Determination of the potential polluting effect of specific technologies and industrial units

2. Development of the laboratory

Implementation period

The periods are indicated in the different contracts signed by UPT. They cover long term cooperation.

Project implemented by

LACIEDIN of UPT (Laboratory for Fuel Analysis, Ecological Investigation and pollutants' Dispersion of the Politehnica University of Timisoara) www.mediu.ro is fully implementing standard 17025/2018.

Main activities

- Preparation of the measuring points (measuring plan) and identification of representative technological regimes
- Calibration of the instruments
- Measurements and verification of the results
- Calculations & Conceiving the report (Technical Bulletin) in accordance with the RENAR specifications

Results

- Technical Bulletins elaborated are attesting the level of pollution of different sources



Applicability and transferability of the results

- Development of a strategy of monitoring, according to the specific needs of the client and support for future developments.
- Raising the visibility of UPT on the free market concerning the collaboration with industrial units.
- Offering to our students of a possibility to be part of the research activity of the teachers.
- Offering to the members of the team a modality to perform, also in industrial cooperation, in addition to the main duties as researcher or university teacher.
- Maintaining the standards & quality for RENAR accreditation.
- Developing skills and knowhow for all personnel involved, including students.



Financed through/by

- diverse frame contracts: BC16/ 25.02.2019; BC36/09.04.2019; BC 78/26.07.2019; BC 79/29.07.2019; BC 82/31.07.2019; BC 101/04.10.2019; BC62/10.06.2019; BC65/18.06.2019, BC 125/09.12.2019; BC120/05.12.2019; BC 121/05.12.2019, BC 33/20.03.2015, and few more.

Research Centre

Research Centre for Thermal Machines and Equipments, Transportation and Environmental Pollution Control, http://www.upt.ro/Informatii_-research-centre-for-thermal-machines-and-equipments-transpo_109_en.html

Through the RENAR accredited laboratory LACIEDIN www.mediu.ro



Research team

Ioana IONEL
Ramon Mihai Balogh
Delia Gabriela TRIF TORDAI
Daniel BISORCA
Virgil STOICA
Gabriela NAGY
Gavril BRATEANU

Contact information

Prof. Ioana IONEL, PhD
Faculty for Mechanical Engineering/ LACIEDIN in the Research Centre for Thermal Machines and Equipments, Transportation and Environmental Pollution Control,
Mihai Viteazu No. 1, Postal Code 30222, Timisoara, Romania
Phone: (+40) 256 403670
Mobile: (+40) 723349337
E-mail: ioana.ionel@upt.ro
Web: www.mediu.ro

AIR QUALITY MONITORING IN DIFFERENT LOCATIONS, ACCORDING CONTRACTS WITH DIVERSE ECONOMIC UNITS, BASED ON THE RENAR ACREDITATION OF THE LACIEDIN LAB

Goal of the project

- Goal of all cooperation contracts is to focus on the potential pollution episodes. The air quality has a huge importance for the health of the population, as well the environment, in general, and assures the quality of life as well.
- The LACIEDIN laboratory, as unique university laboratory for air quality monitoring in the region, offers, long term measurements' campaigns, that are absolute necessary to attest the quality of air in the region. It measures: CO, NOx, VOC's, particles, O3, benzene, etc. The goal of the projects is to offer a data base concerning air quality and specific other information, attested by a RENAR qualified laboratory.
- main clients of our lab are indicated in the followings: SC CENTRALA ELECTRICA DE TERMOFICARE HIDROCARBURI S.A. ARAD; INSTITUTUL NATIONAL DE CERCETARE DEZVOLTARE PENTRU ENERGIE - ICEMENERG BUCURESTI (as subcontractor for RETEAUA ELECTRICA DE TRANSPORT LEA - ST TIMISOARA); COMBINATUL AGROINDUSTRIAL OLARI; COMSA SA BARCELONA - SUCURSALA BUCURESTI; SPUMOTIM S.A. TIMISOARA; FRIGOGLOSS SRL PARTA, SC PORKPROD IRATOSU, STERICYCLE ROMANIA SRL, and others.
- One expresses respect & appreciation for all industrial partners, and thank for the opportunity to serve their interest.

Short description of the project

TESTS according legislation and standard methods:

1. Gravimetric tests (dust) affecting air quality,
2. Specific tests for specific gaseous pollutants in air,
3. Physical tests.

- SCOPE:
1. Determination of air quality in different regions –rural or urban & industrial sites
 2. Identification of potential impact of several pollutants upon the air quality and future strategies

Implementation period

The periods are indicated in the different contracts signed by UPT. They cover long term cooperation.

Project implemented by

LACIEDIN of UPT (Laboratory for Fuel Analysis, Ecological Investigation and pollutants' Dispersion of the Politehnica University of Timisoara) www.mediu.ro is fully implementing standard 17025/2018.

Main activities

- Identification of the most representative regimes for measuring
- Identification of the safety conditions for the workers
- Preparation of the measuring points (measuring plan)
- Calibration of the instruments
- Measurements and verification of the results
- Calculations
- Conceiving the report (Technical Bulletin) in accordance with the RENAR specifications.

Results

- Technical Bulletins elaborated are attesting the level of pollution in the areas, and generally can be used to inform the population as well, if the client is giving its approval..



Applicability and transferability of the results

- Development of a strategy of monitoring, according to the specific needs of the client.
- Raising the visibility of UPT on the free market concerning the collaboration with industrial units.
- Offering to our students of a possibility to analyse real pollution episodes and develop information based on own experience.
- Offering to the members of the team a modality to perform, also in industrial cooperation, in addition to the main duties as researcher or university teacher.
- Maintaining the quality for next RENAR accreditation.
- Developing skills and knowhow for all personnel involved, including students.



Financed through/by

- Diverse frame contracts such as: BC16/ 25.02.2019; BC36/09.04.2019; BC 78/26.07.2019; BC 79/29.07.2019; BC 82/31.07.2019; BC 101/04.10.2019, BC 26/ 21.03.2019 and few more.

Research Centre

Research Centre for Thermal Machines and Equipments, Transportation and Environmental Pollution Control, http://www.upt.ro/Informatii_-research-centre-for-thermal-machines-and-equipments-transpo_109_en.html

Through the RENAR accredited laboratory LACIEDIN www.mediu.ro

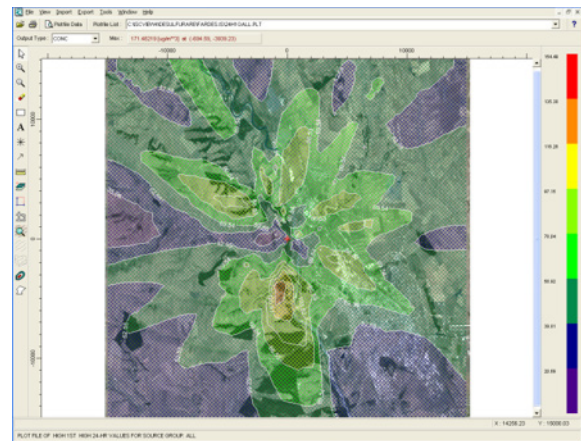

Research team

Ioana IONEL
Ramon Mihai Balogh
Delia Gabriela TRIF TORDAI
Daniel BISORCA
Virgil STOICA
Gabriela NAGY
Gavril BRATEANU

Contact information

Prof. Ioana IONEL, PhD
Faculty for Mechanical Engineering/ LACIEDIN in the Research Centre for Thermal Machines and Equipments, Transportation and Environmental Pollution Control,
Mihai Viteazu No. 1, Postal Code 30222, Timisoara, Romania
Phone: (+40) 256 403670
Mobile: (+40) 723349337
E-mail: ioana.ionel@upt.ro
Web: www.mediu.ro

COMPLEX MEASUREMENTS FOR THE DETERMINATION OF POLLUTANT EMISSIONS AT THE TIMISOARA (16 MĂCIN STR.), ORAVIȚA, LUPENI AND MARGHITA UNITS OF THE COMPANY TRW AUTOMOTIVE SAFETY SYSTEMS

Goal of the project

Identifying the level of pollution generated by specific units in the company. Thus, by analyzing the results, the specialists from TRW Automotive Safety Systems can adapt and reconsider their technologies, in order to optimize/ reduce the emissions' levels/concentrations, if they are not appropriate and in correlation with the emission control legislation.

Thus the company can maintain its leading position in the frame of all Romanian production companies, knowing that TRW Automotive Safety Systems gained by 2018 the third place for cooperation in Romania (diploma offered by ListaFirme.ro, 2018).

Short description of the project

TESTS:

- 1.Gravimetric tests (dust) (emissions);
- 2.Electrochemical tests;
- 3.Flame ionization tests;
- 4.Physical tests.

SCOPE:

1. Determination of total dusts (emissions).
2. Determination of combustion gas concentrations (O₂, CO, CO₂, H₂S, SO₂ and CH₄)
3. Determination with flame ionization detector of COV / COT.
4. Determination of physical parameters (pressure, speed and flow).

FEEDBACK:

The client is offering a feedback by filling in a specific file, that enables us to improve the offer and cooperation activity for the future.

Implementation period

Starting 15.04.2019, up to 24 months, with potential prolonging of the cooperation availability of the contract, at request

Project implemented by

- LACIEDIN of UPT (Laboratory for Fuel Analysis, Ecological Investigation and pollutants' Dispersion of the Politehnica University of Timisoara) www.mediu.ro
- The LAB is profound anchored in the reality of the present society and devoted to the protection of the environment. Through the product offered it assists and helps all the clients greatly to prevent and combat the specific pollution level resulted from their production. LACIEDIN is fully implementing standard 17025/2018.

Main activities

- Identification of the most representative regimes for measuring
- Identification of the safety conditions for the workers
- Preparation of the measuring points (measuring plan)
- Calibration of the instruments
- Measurements and verification of the results
- Calculations
- Conceiving the report (Technical Bulletin) in accordance with the RENAR specifications

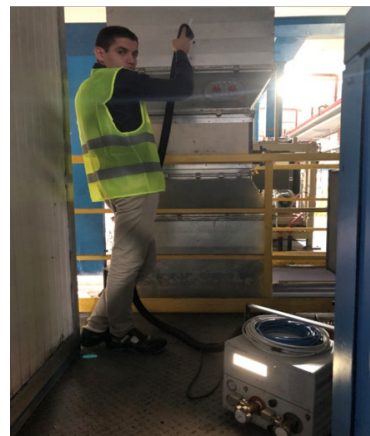

Results

Technical Bulletins attesting the level of pollution exhausted by diverse facilities, as identified by the Agency of Environmental protection as to be monitored on specific intervals, during representative technological episodes.

Applicability and transferability of the results

- Development of a strategy of monitoring, according to the specific needs of the client.
- Raising the visibility of UPT on the free market concerning the collaboration with industrial units.
- Offering to the members of the team a modality to perform, also in industrial cooperation, in addition to the main duties as researcher or university teacher.
- Maintaining the quality according to existing RENAR accreditation.
- Developing skills and knowhow for all personnel involved.
- Supporting practical development for the students and correlation of research with theory.



Research Centre

Research Centre for Thermal Machines and Equipments, Transportation and Environmental Pollution Control, http://www.upt.ro/Informatii_research-centre-for-thermal-machines-and-equipments-transpo_109_en.html
Through the RENAR accredited laboratory LACIEDIN www.mediu.ro

Financed through/by

- Contract BC 40/12.04.2019 signed by UPT with TRW Automotive Safety Systems

Research team

Ioana IONEL
Ramon Mihai Balogh
Delia Gabriela TRIF TORDAI
Daniel BISORCA
Virgil STOICA
Gabriela NAGY
Gavril BRATEANU

Contact information

Prof. Ioana IONEL, PhD
Faculty for Mechanical Engineering/ LACIEDIN in the Research Centre for Thermal Machines and Equipments, Transportation and Environmental Pollution Control,
Mihai Viteazu No. 1, Postal Code 30222, Timisoara, Romania
Phone: (+40) 256 403670
Mobile: (+40) 723349337
E-mail: ioana.ionel@upt.ro
Web: www.mediu.ro

STUDY FOR SMALL HYDROPOWER PLANTS ON BÂRZAVA RIVER, AS LOCALLY ADAPTED SOLUTION FOR INVESTMENT IN RENEWABLE ENERGY AND PUBLIC UTILITIES INFRASTRUCTURE

Goal of the project

The study is mainly concerned by the implementation of extension of the water supply and the domestic sewerage network for the area of tourist resorts of local interest Secu, Reșița municipality, construction of non-motorized pedestrian and bicycle track to the Secu resort area and providing a protective tube for the electrical cables, lighting, internet, telephony, etc., for the Secu station area.

Short description of the project

Following analysis, the project identifies two accomplishment scenarios from which the technical-economical optimum solution for the extension of the water supply and the domestic sewerage network and the construction of non-motorized track for the Secu tourist resort area.

Implementation period

2019–2020 (19 months)

Financed through/by

Resita Municipality

Main activities



The extension of the drinking water supply network of the objective will be made of PE-HD, PE100, PN16, with De 180 mm, on a length of approximately $L = 7,469$ m. 2 tanks with the volume of $V = 200$ m³ each will be provided, a pumping station for the tank R1 and a pumping station for the tank R2.

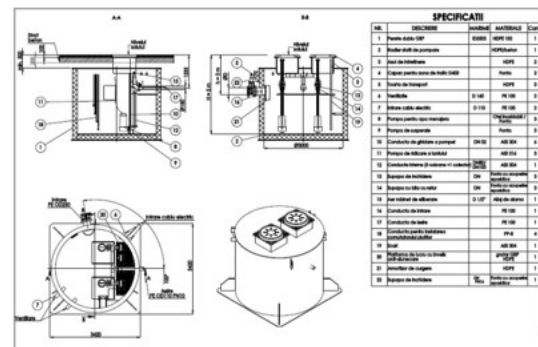

The extension of the sewerage network of the objective implies:

- wastewater discharge pipe from PE-HD, PE100, PN10, with De 200 x 11.9 mm in length of 3,903 m from the wastewater pumping station at the highest point on the route;

- wastewater discharge pipe from PE-HD, PE100, PN16, with 180 x 16.4 mm in length of 4,170 m from the highest point on the route to the existing manhole on Rozelor Street.

On the location of the track bikes, according to the situation plan and the transversal profile, a corrugated protection tube made of PE-HD with De 110 mm is positioned for the protection of the existing or future cables of telephony, electrical, internet, lighting, etc. The total length of the protection tube is 7,394 m.

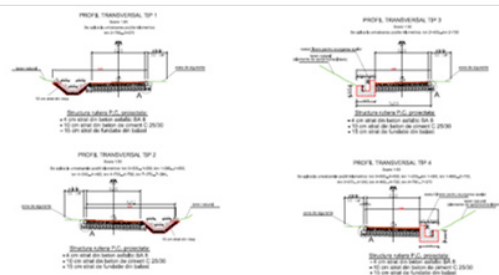
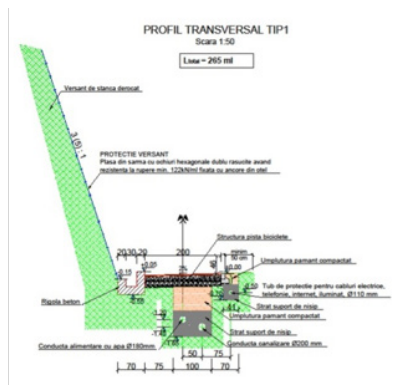

- The projected route of the runway runs over a length of 7,394 m, on the administrative territory of Reșița municipality, Caraș-Severin county.
- It serves the inhabitants of the area as well as the tourists who generate the bicycle traffic in the area.

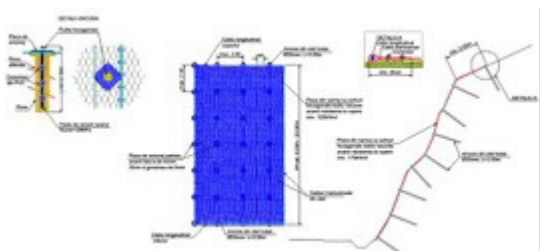

On the projected water–canal route, respectively the bicycle track, in the areas where the existing road is close to the slope, given the width of the bicycle track, respectively of the imposed safety zones, including gutters, demolition works are required in the slope, the total length (cumulated by sectors) being about 1,625 m.

Results

Ensuring the traffic of tourists by bicycle and the degree of comfort in the tourist resort Secu through the water and sewerage system.

Applicability and transferability of the results

Providing a water supply and sewerage system for the Secu tourist resort and the bicycle track for tourists.

Research team

Albert Titus CONSTANTIN,
Constantin FLORESCU,
Ion MIREL,
Marin MARIN,
Ioan ȘUMĂLAN,
Ciprian COSTESCU,
Cristian STĂNILOIU,
Serban –Vlad NICOARA,
Alina POPESCU – BUSAN,
Mircea VIȘESCU, Marius ADAM,
Dan PÎRVULESCU,
Ioana-Alina CREȚAN,
Liliana COTOARBĂ

Contact information

Assist. Prof. Albert Titus CONSTANTIN, PhD
Faculty of Civil Engineering
Department of Hydrotechnical Engineering
Address: 1A George Enescu Street, 300022, Timișoara, Romania
Phone: (+40) 256 404091
Mobile: +40 720 059 371
E-mail: albert.constantin@upt.ro
<https://www.ct.upt.ro/en/hidro/index.htm>

CONSULTING FOR THE USAGE OF MACHINE LEARNING FOR MACHINE VISION APPLICATIONS

Goal of the project

Machine learning consists of scientific study of algorithms and statistical models that computer systems use to effectively perform a specific task. Machine learning algorithms are used in a wide variety of applications (as computer vision is) where it is infeasible to develop an algorithm of specific instructions. Data mining is a field within machine learning, and focuses on exploratory data analysis through unsupervised learning. In its application across business problems, machine learning is also referred to as predictive analytics.

EVT has developed machine vision products, which not only allow precise and error-free image processing, but also products, which are one step ahead of the market. The machine vision software EyeVision by EVT is a product, which due to easy-handling is able to adopt to various applications. The research trends for it follow to enhance easy programming, easy-handling, versatility, extensibility and to get fast solutions.

Short description of the project

EyeVision is a complete image processing package for every possible field of application. EyeVision is connecting a powerful, hardware platform independent software for Windows and Linux with a wide range of hardware for image capture and digital I/O.

All industrial inspection tasks are done fast and effectively by the all-in-one image processing software EyeVision.

Implementation period

01.04.2018 - 01.04.2020

Main activities

- Image Processing largely involves several processes to gain information from source data, such as for example image recognition and pattern matching. With the usual methods for image processing one can for example count objects, measure, inspect or read coded information. Image processing nowadays is used in nearly every science and engineering disciplines. One domain for image processing is the quality control at production processes such as automotive engineering, electrical and semiconductor industries, food industry and pharmaceutical industry.
- We focused on research and development of the hardware platform independent software for Windows and Linux - technical. We offer consultancy in the field of all-in-one image processing software.
- Consulting services for using applications at Machine Learning for Machine Vision.

Results

- Machine Vision Software for VisionSensors, SmartCameras and PC Systems - EyeVision the one software for all Hardware Platforms.
- For programmers a PlugIn Interface was made, which supports easy to integrate software modules.
- The software supports all major interfaces for cameras e.g. USB, FireWire, GigE, CL, CoaXPress and analog.

Applicability and transferability of the results

- A build in WebServer for easy remote control as well as interfaces to SAP Oracle and SQL.
- EyeVision Software is available.

Financed through/by

EVT Eye Vision Technology GmbH, Karlsruhe Germany

Research team

Prof. Ivan BOGDANOV, PhD

Contact information

Prof. Ivan BOGDANOV, PhD
Faculty of Electronics, Telecommunications and Information Technology
Department of Applied Electronics
Address: Bvd. Vasile Parvan, No.2, 300223, Timisoara
Phone: (+40) 256 403 338
E-mail: ivan.bogdanov@upt.ro

SOFTWARE MODULE FOR THE ENERGETIC ASSESSMENT OF HYDRAULIC GENERATORS OPERATION IN AQUATIM'S DRINKING WATER SYSTEM

Goal of the project

The goal of the project was to create a simple to use software system validated by experimental results for the quick assessment and monitoring of the efficiency of hydraulic generators deployed in Aquatim's Drinking Water System.

Short description of the project

The project contained three phases:

Phase 1 27.03.2018 – 30.06.2018, for the development of the algorithms for constant-speed pump efficiency assessment and variable-speed pump efficiency assessment.

Phase 2 01.07.2018 – 30.09.2018, for the validation and testing of the software module against laboratory experimental data from a variable-speed pump.

Phase 3 01.10.2018 – 27.12.2018, for the development of the graphical user interface for the central desktop system and for the mobile, smartphone application.

Main activities

- The development of a software module for the energetic assessment of hydraulic generators operation in Aquatim's Drinking Water System in two parts: the desktop application and the smartphone application.
- All software results have been validated with in situ and laboratory experiments for constant-speed pumps and for variable-speed pumps.



Results

An interdisciplinary expert software solution for the energetic assessment of hydraulic generators operation in Aquatim's Drinking Water System in two parts: two desktop applications and the smartphone application.

The desktop applications generate QR code stickers for each hydraulic generator configuration for constant-speed pumps and for variable-speed pumps.

The QR codes are scanned by the mobile application which works both for constant-speed pumps and variable-speed pumps. The hydraulic route is encoded in the QR codes in addition to polynomial curve fitting coefficients, in order to allow the correct assessment of the efficiency for each pump configuration.

Applicability and transferability of the results

- The results are tailored for the energetic assessment of hydraulic generators operation in Aquatim's drinking water system.



Implementation period

23.02.2018-22.02.2019

Financed through/by

AQUATIM S.A.

Research Centre

Research Center in Computer and Information Technology (CCCTI)

Research team

Assist. Prof. Alin-Adrian ANTON, PhD
Eng. Daniel Calin MOS, PhD Student
CS1 Sebastian MUNTEAN, PhD

Contact information

Assistant Prof. Alin-Adrian ANTON, PhD
Faculty of Automation and Computers
Department of Computer and Information Technology
Address: BvdI. Vasile Parvan no.2. 300223, Timisoara
Phone: (+40) 256 403 281
Mobile: (+40) 745 001010
E-mail: alin.anton@cs.upt.ro
Web: <http://staff.cs.upt.ro/~alin.anton>

PROTOTYPE RESEARCH AND DEVELOPMENT FOR IMAGE PROCESSING SOLUTION FOR BOARDS TESTING IN THE AUTOMOTIVE INDUSTRY

Goal of the project

The main goal of the project is to obtain a prototype, able to execute boards inspection, based on image processing, functioning in accordance with the company requirements for the production line.

Short description of the project

The starting point of the project was represented by an experimental model. The activities were to adapt, to improve, to test and to validate the software from the experimental model within a new mechanical-hardware structure in order to obtain a prototype that is able to perform ECU tests based on image processing functioning in accordance to the Hella company requirements in the production line.

Implementation period

22/11/2018-22/03/2019

Main activities

The prototype was conceived and implemented, and the solution was integrated, tested and validated in the production line.

Results

Some results are detailed below:

- 1) Starting from the experimental model (consisting of 4 compact modules, each containing a Raspberry Pi and a camera), the solution was modified within the prototype in order to fit the high number of different ECUs from the production line and to reach the test indicators. A prototype solution was conceived and implemented, based on 6 Raspberry Pis and 6 cameras, this time physically separated, and improving the quality of the inspection for the connectors with perspective issues. Having separated cameras, the prototype allows besides higher possibilities to eliminate the perspective, a higher luminosity on the ECUs analyzed surface.
- 2) The capability to vehiculate data between 1 master and 5 slaves, including from request/response transmissions toward data aggregation, concluding procedures and reporting.
- 3) A generic platform was created for n processing modules. Therefore now, the prototype contains only two branches: 1 master branch and 1 slave branch, and the software from the slaves is generic for any Raspberry Pi slave in the scheme.
- 4) The prototype solution is extended to function for the 4 main classes of ECUs from the production line. The extension required a whole new concept for the software module.
- 5) Modules were conceived and developed to include layouts from all main classes of boards and all the particular sets of boards inside the main classes.

- 6) The pin search module was optimized to reduce the search area and the processing times.
- 7) New detection modules were researched and implemented based on islands identification, separation and grouping, for more accurate conclusions.
- 8) A new method was researched and developed to establish a dynamic illumination threshold associated to each pin.
- 9) The layout saving, storing and loading was optimized due to the high number of layouts in the production line.
- 10) Detection task request optimizing was researched and implemented mainly in a sense that the master equipment extracts and sends a list of the connectors to analyze for each slave equipment. This procedure eliminates the fix slaves, each being able to be replaced without application issues.
- 11) The processing time was significantly reduced by eliminating the necessity of connector rotation for the slave's software.
- 12) A new module was implemented for new layout learning, placed only on the master equipment. This way no ssh/vnc connection is necessary for each slave.
- 13) A new offset (search area) separation was researched and implemented so that each pin has now its own offset. Also, a new module was created that establishes the filling factor for the offset for each pin.
- 15) The prototype is able to apply all the changes in configuration from the graphical user interface.
- 16) The prototype functions in complete correlation with the traceability software within the company.

Financed through/by

HELLA ROMANIA S.R.L.

Research team

Adrian Stefan KORODI, Ioan SILEA, Alexandru Brian BOITOR
Denis Florin ANITEI, Mariana Daniela GIUCHICI

Contact information

Assistant Prof. Adrian KORODI, PhD
Faculty of Automation and Computers Science
Department of Automation and Applied Informatics
Address: Bd. Vasile Parvan, No. 2, 300223, Timisoara
E-mail: adrian.korodi@upt.ro

PATENTS

EVOLUTION OF PATENTS UNDER AFFILIATIONS OF UPT 2015 - 2019

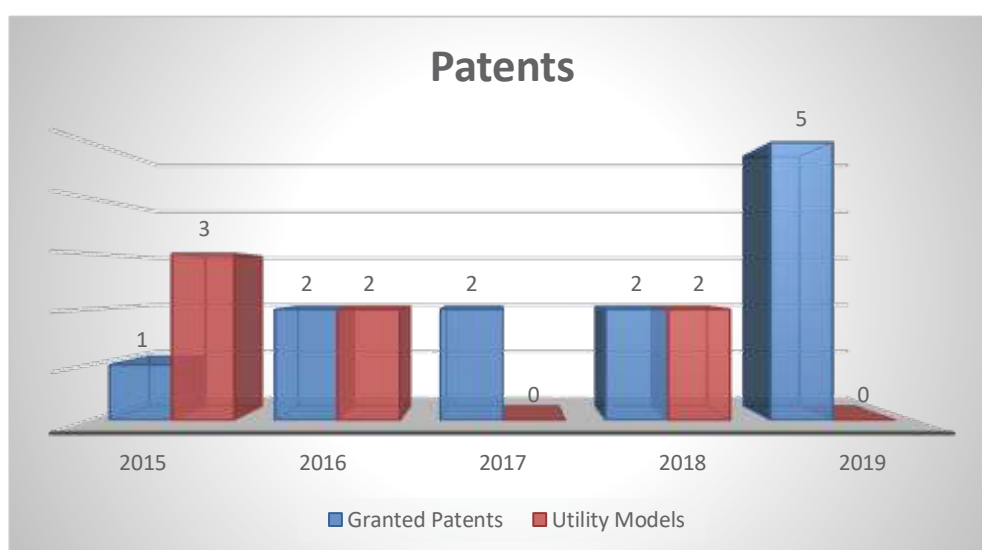

The innovative capacity of the Politehnica University Timisoara is supported by teachers and scientific researchers through patents and utility models invented, presented in this section.

Granted Patents

INVENTORS: MUNTEAN SEBASTIAN, SUSAN-RESIGA ROMEO-FLORIN, BOSIOC ILIE ALIN, CONSTANTIN SORIN RĂZVAN, MAXIM DANIEL IOSIF, TANASA CONSTANTIN, VEKAS LADISLAU-NICOLAE, BORBATH ISTVAN, ANTON LIVIU-EUGEN.

PATENT NO. 131578 / 2019

EQUIPMENT FOR REDUCING CAVITATIONAL EFFECTS AND LEVELING FLOW AT TURBO PUMPS INLET



The invention relates to an equipment for reducing cavitation effects and for leveling the flow at the inlet of turbo-pumps operating at flows different from the flow they were designed for, turbo-pumps which may be used for irrigations, water supply of towns and industrial objectives and for heating systems.

According to the invention, the equipment consists of a pipe (1) which takes over the water from a downstream lake or a well through a suction pipe elbow (3) to a rotor of turbo-pump (5) driven by an electric motor (6) using a shaft (9) and leads it to an accumulator (10) and a discharge pipe (11) for controlling the cavitation and levelling the flow.

It is used the controlled variable speed of an impeller (4) in relation to the constant speed of the shaft (9) of the rotor of the turbo-pump (5) by mounting the impeller (4) coaxial onto a shaft (8) and the shaft (9), the shaft (8) of the impeller (4) and the shaft (9) of the turbo-pump being driven by means of a control device (7) which comprises a magneto-rheological clutch which, by the control of an automation device or an operator, allows the differentiation between the speeds of the impeller (4) and the shaft (9) of the rotor of the turbo-pump (5), the control device (7) consisting of a cylindrical flange (13) fixed onto the output shaft of a driving motor (6), the flange (13) being connected through an elastic coupling (15) to

another semi-cylindrical flange (14), which is fixed onto an iron piece (17) integral with the shaft (9) of the turbo-pump, the shaft (8) of the impeller (4) being in rotary motion on ball bearings inside the borehole thereof, while, between the shafts (8 and 9) a mechanical coupling is provided by means of a magneto-rheological fluid (16) the viscosity of which may be controlled and adjusted by the size of the magnetic field directed by a mechanism or an operator, which is transmitted to an electromagnet (18) by means of a slip ring (19).

INVENTORS: ICLANZAN TUDOR ALEXANDRU, STAN DANIEL VOICU, TULCAN AUREL, COSMA CRISTIAN, DUME ADRIAN ILIE, TULCAN LILIANA GEORGETA

PATENT NO. 129443 / 2019

MOLD AND METHOD FOR THE INJECTION OF MINIATURE PARTS



The claimed method propose a new non-conventional approach for forming small plastic parts from thermoplastic material detached from a plastic strip as raw material.

As method, the shaping of the small/miniature parts as described below, is done by copying the geometry of a nest by the molten plastic material brought into this and melted here as a result of the thermal conversion of the mechanical energy provided by an ultrasonic activation system attached to the molding device and not by using of a conventional, regular, injection machine which melts the raw material.

The claimed equipment for carrying out the method looks like a regular mold, Figure 1, which carries in the movable half an attached ultrasonic system US1, (4), whose concentrator (6) participates himself with its front side at the nest configuration (case 1) or it will work as a plunger in the injection antechamber as shown in Figure 2 and 3 (case 2). For better results, a second ultrasonic system US2 could be attached at the counter plate (8).

In the raised position, the concentrator (6) exits the forming subassembly (A), and the thermoplastic material strip (7) is brought under the front of the concentrator.

Until this moment, this equipment is working is a punching device, having a side piercer for assuring step-by-step advance of the strip.

When the concentrator (6) goes down, it detaches by cutting (punching, through contour) material from the strip, as sufficient amount to form the product to be manufactured.

Next, the concentrator (6) continues the descending race and this detached material is pushed into the forming subassembly (A), in the nest (case 1) or into the injection antechamber (Figure 2 and 3, case 2), it is pressed, at which point the ultrasonic activation system is put into operation. The mechanical energy of the ultrasonic vibration is converted into thermal energy and the pressed material passes into a molten state, it fills the entire cavity copying the shape of this (the basic principle of injection as a forming process). The exceeding material will be evacuated through leakage channels located peripheral on the nest (case 1) or will remain in the injection antechamber as shown in Figure 2 and 3 (case 2).

After forming, the compression of the material in the nest is maintained until the passage in solid state of this, technological step that can be rushed by passing cooling water through the channels of the counter plate (8).

Advantages for using the technology as described above:

- does not require conventional, regular, injection machine;
- the forming of the part to be manufactured is obtained by pressing the melt in the nest and not by flowing, the shrinkage of the material will be uniform in the volume of the part and the dimensional accuracy of this will be better than in the case of conventional injection molding.
- the proposed technology can be applied for the shaping of small products from thermoplastic material with high viscosity that, in the case of the classic microinjection, raises problems of filling the nest. Can be also be applied for nonsuitable material for injection such as fluoropolymers.

Limitations:

The limitation in size and weight of the product that can be modeled may arise from the need to ensure a certain value of the power density on the front, active surface, of the concentrator (6) that needs to be between 15 and 100 W / cm², depending on the nature of the thermoplastic material to be processed. The ultrasonic system used to activate the nest uses frequencies between 20 and 60 KHz, with the nominal power of the ultrasonic generator between 50 and 1000 W.

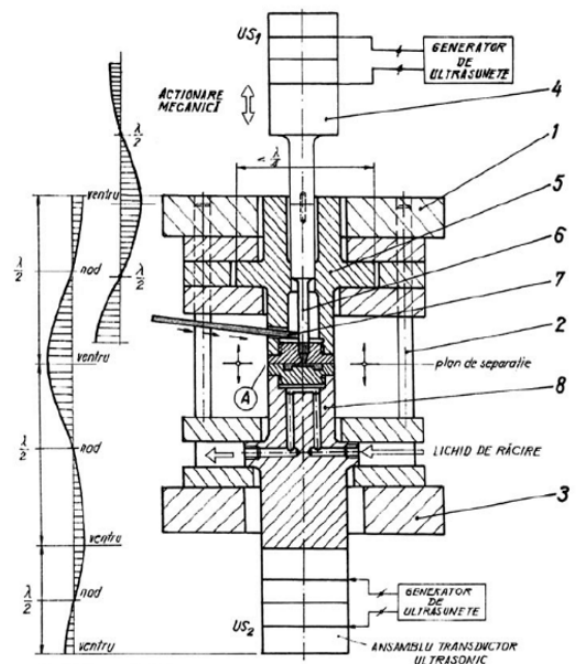

Fig. 1

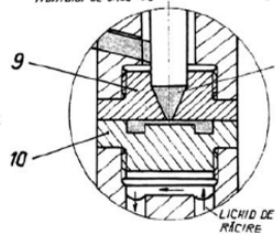

Fig. 2

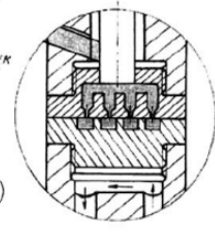

Fig. 3

INVENTORS: GONTEAN AUREL ȘTEFAN, CERNAIANU MIHAIL OCTAVIAN

PATENT NO. 129477 / 2019

HYBRID THERMOELECTRIC SOLAR SYSTEM



The invention relates to a solar thermal system - electric, hybrid, which produces domestic hot water and electricity using thermoelectric modules.

The solar thermo-electric hybrid (figure 1) is composed of a concentrator, 1, with paraboloid cavity covered with reflecting mirrors, 2 (figure 3), arranged in a mosaic, over the interior surface, to ensure the capture and reflecting the sun light in a concentrated way towards the upper end of a collector 3, containing the TEGs, which provides the conversion of solar energy collected into electrical energy by means of a support 4, placed on a frame 5, shaped "L", which supports both the concentrator, 1 and the collector, 3 in various positions.

To ensure the maximum efficiency the solar tracking is possible using a tilt mechanism, 6, and pan mechanism, 7, 8. The baseplate, 9 has enough sturdiness to permit the attachment of the system and offer stability against wind.

The parabolic collector/concentrator 1, contains even shaped hexagonal mirrors, 10 and PV cells, 2 (figure 2). The electrical efficiency of the system and the hot water produced can be optimized by modifying the amount of photovoltaic cells used on the surface of collector. The energy of sunlight which enters the mirrors parallel to their plane is focused along the focal point, where the TEG 3, is placed.

Figure 1 represents the proposal for the solar collector, 3, built around the TEGs to produce the hot water and electricity. The TEG is placed in a cylindrical glass-like shaped duralumin with a lateral connection 12, connected to a vacuum pump. In the opposite side there is a hole filled with a rubber stopper 13, which ensure a good isolation and where wires attached to 4 connected serially TEGs, 14, exit from the module. The connection is made using low thermal conductivity fiber screws, 15. A black body metal plate, 16, ensure a good light absorption and a good thermal connection between the TEGs and the rest of the module. In the upper side of the module, a circular window is covered with a convex heat-resistant glass, 17, with good optical properties. The glass window is glued with a sealant ring, 18, to ensure a hermetic tightness. To obtain a good thermal isolation between the hot and cold junction of the TEG, the air is removed from the cylindrical cavity using a vacuum pump obtaining a low pressure of $\sim 10^{-2}$ mbar. The bottom of the cylindrical shape, 11, is fixed with screws, 19, to a metal plate, 20, which contains high thermal conductivity aluminum silver anodized tubes, 21. The inside of the tubes are filled with an adequate liquid to ensure the heat transfer from the TEG module to the storage boiler. The module is connected to the "L" shaped bar, 4 and the support, 5 of the solar thermo-electric system with two isolation rings which ensure good thermal isolation from the system chassis.

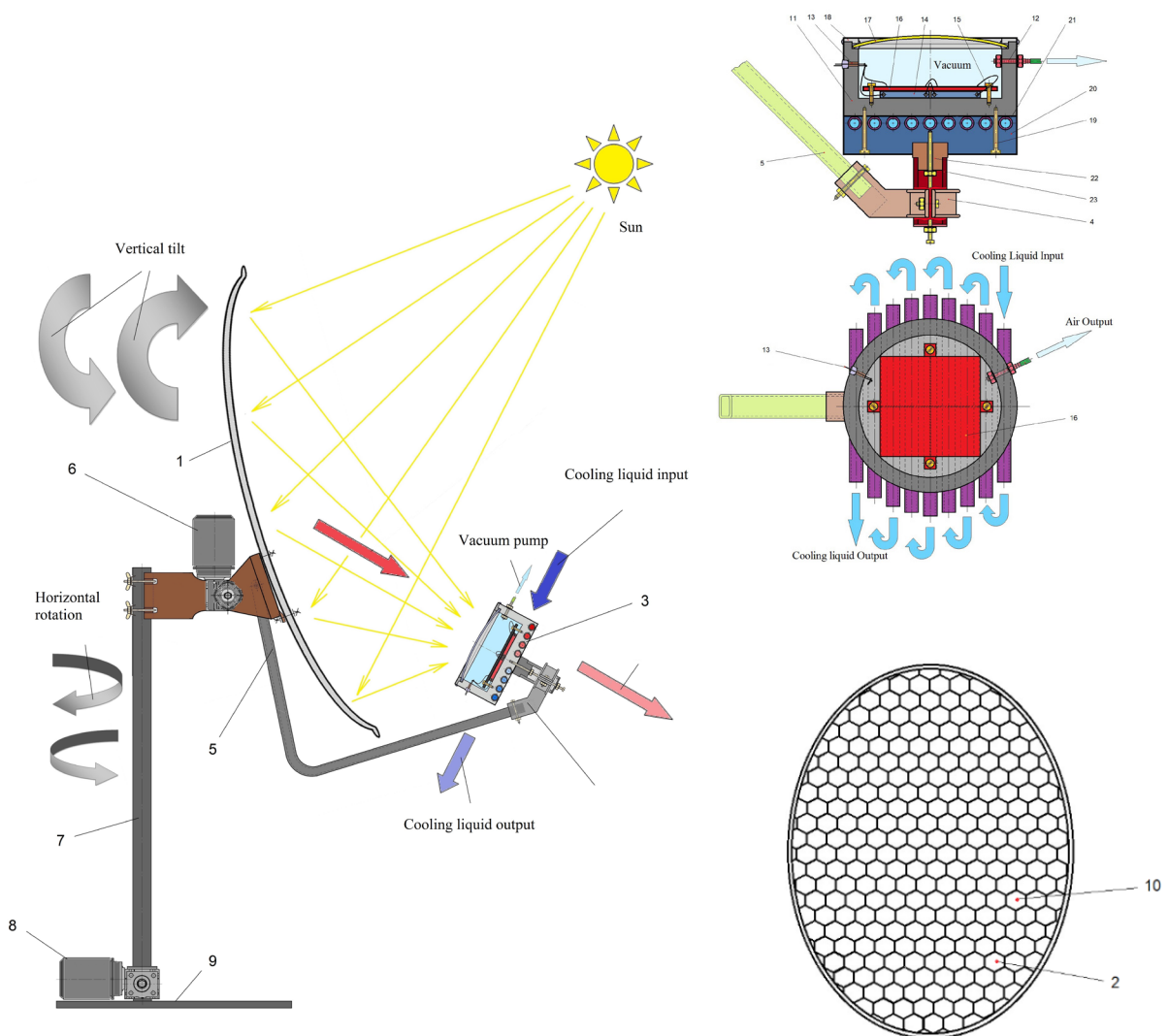

INVENTORS: HEPUȚ TEODOR, CRIȘAN EUGEN, ARDELEAN ERIKA, SOCALICI ANA, ARDELEAN MARIUS

PATENT NO. 127756 / 2019

CYLINDRICAL MULTI-HOLLOW BRIQUETTE PRODUCED OF FERROUS PULVEROUS WASTE



The invention relates to a cylindrical multi-hollow briquette obtained from ferrous pulverous and small waste with a grain size of less than 2 mm, said briquette being used in ferrous metallurgy in the wind furnaces producing the refining iron or in the installations for direct reduction of iron in order to produce iron sponge.

The multi-hollow cylindrical shape of the lighter ensures the growth of the reaction surfaces, respectively of the speed of reduction of iron oxides, compared to conventional lighters, with positive effects on productivity, energy consumption and on the degree of usage of the reductant. Also, using them in reducing ovens ensures a good permeability to gases of the material column.

Ferrous waste in the composition: steel plant dust, furnace dust, furnace agglomeration sludge and iron scale sludge.

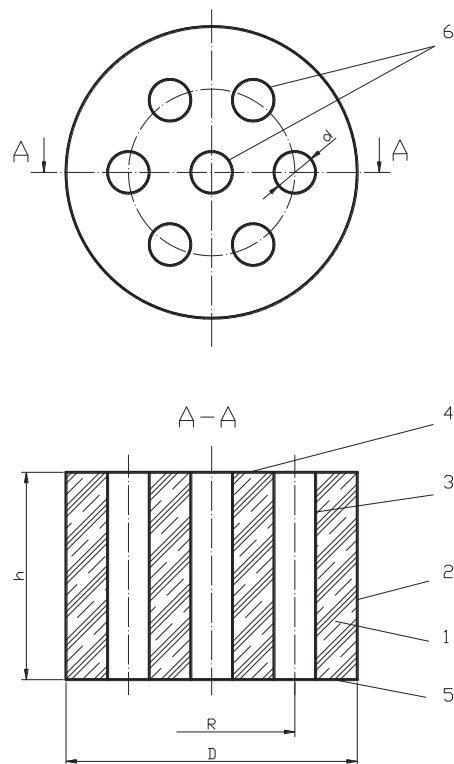

INVENTORS: SUSAN-RESIGA ROMEO-FLORIN, MUNTEAN SEBASTIAN, TĂNASĂ CONSTANTIN, BOSIIOC ILIE ALIN, CIOCAN TIBERIU, POPESCU CONSTANTIN

PATENT NO. 131408 / 2019

EQUIPMENT FOR CONTROLLING INSTABILITIES OF SWIRL FLOW FROM THE CONICAL DIFFUSER OF HYDRAULIC TURBINES



The invention relates to an equipment for controlling the instabilities of the swirl flow from the conical diffuser of hydraulic turbines which run at partial flow rate.

According to the invention, the equipment comprises a bypass pipe (11), a regulating gate (VR), a rotary valve (VO), a calming basin (R) and water injection pipe (12) which, connected in series, link an upstream reservoir (1) and a rotor of the turbine (7), the bypass pipe (11) is connected to a pipe (2) for the delivery of water from the upstream reservoir (1), and the bypass pipe (11) is continued by the regulating gate (VR) which controls the flow rate of the pulsatile jet.

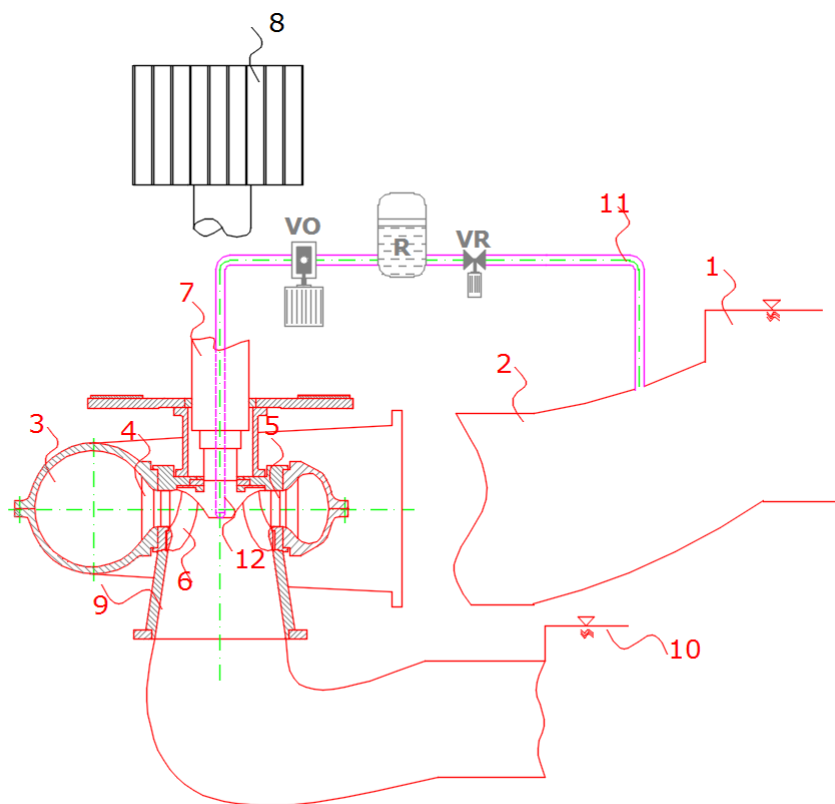

HONORARY MEMBERS

EVOLUTION OF HONORARY MEMBERS OF UPT 2015 - 2019

The conferring of honorary degrees is one way in which the University recognizes individuals distinguished by accomplishments consonant with the overarching mission of the University.

Nominees may be eminent scholars, scientists, artists, or professionals who have advanced their disciplines in important ways, or they may be individuals outside of the academic world who have made particularly distinguished contributions to society.

Politehnica University Timisoara recognizes scientific excellence by conferring the honorary degree of Doctor Honoris Causa and Honorary Professor to distinguished Researchers for their contribution to the development of UPT and continuous support.

The University strives for a robust pool of honorary degree recipients enriched by individuals from all backgrounds of engineering.

We also find it rewarding to honor individuals who have not already been publicly recognized by a number of other institutions.

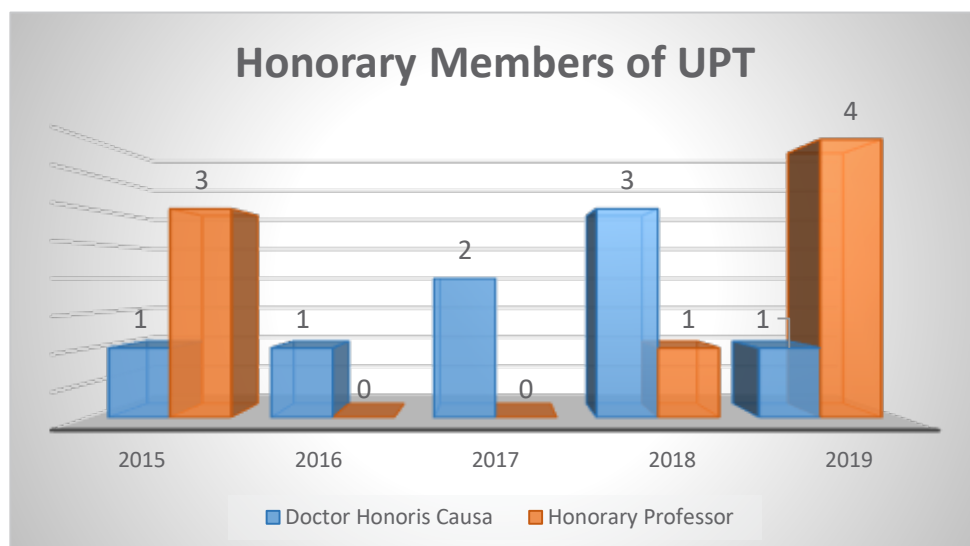

DOCTOR HONORIS CAUSA Professor Eng. Ewald A. WERNER, PhD

Ewald A. Werner was born in Austria in 1956. After prolonged military service and officer training Mr. Werner entered the University of Leoben (Montanuniversität), Austria in 1975 where he majored in Materials Science and Metal Physics. He obtained the degree Dipl. Eng. in 1980 and graduated summa cum laude. He then studied Pure Mathematics at the University of Graz, Austria (1981-1982).

Starting with April 2007 he has fulfilled an academic position as professor and Department Leader for Integrated Systems at Ruhr-University-Bochum for a period of 3 years.

Prof. Werner started his educational career in 1977, currently he presents courses in Mechanical Engineering and Materials Science for Bachelor, Technology, Mechanics of materials, Theory of Dislocations, Numerical modeling, Quantitative metallography, Non-destructive and destructive materials testing for Master programs in Mechanics and Chemical Engineering and Engineering studies. On the same time he supervised 40 PhD students.

In 1997 Werner was appointed a scientific member of the Max-Planck Society and was offered the position of a Director at the Max-Planck Institute for Steel Research at Düsseldorf, Germany. He instead accepted the offer to join the Faculty of Mechanical Engineering at the Technische Universität München, Germany, as a full professor. From 1997 to 2001 he was head of the Chair of Mechanical Sciences, which is famous for its contributions to mechanics of materials, dynamics, fracture mechanics and plasticity (predecessors were: Bauschinger, Föppl (father and son), Neuber and Lippmann). He also serves as head of the State Laboratory for Material Testing in Mechanical Engineering, being the oldest material testing laboratory on the European mainland (founded by Bauschinger in 1871) and which is a highly recognized partner for industry in the fields of material and component testing, microstructure analysis, fracture mechanics and calibration and development of testing equipment. Prof. Werner headed the Christian-Doppler Laboratory for Modern Multiphase Alloys (1998-2005) conducting application driven basic research on a great variety of steels. Since 2002 he is full professor for Materials Science and Mechanics of Materials.

Throughout his career the researches were focused on the development, processing and testing of new materials such as low alloyed TRIP-, interstitial free-, bake hardening-, ferritic-martensitic-, ferritic-bainitic- and ferritic-austenitic-duplex-steels, metal matrix composites, aluminum, nickel, titanium and high-entropy alloys for automotive, aeronautical, electronic and biomedical applications. Between Politehnica University Timisoara and TU München exists a long term cooperation in the framework of educational domain through programs like Erasmus – Socrates, and in the research field. Particularly between Department of Mechanical Engineering from TU Munich and Departments of Mechanics and Strength of



materials, and Materials Engineering and Fabrication from University Politehnica Timisoara, exists a close collaboration relationship materialized on: mutual support of scientific events (at AMS 2018 Conference organized by UP Timisoara a delegation from TU München participated, led by Prof. Werner), exchange of experienced researchers (4 researchers from UP Timisoara visited TU München in November 2017), exchange of experience of the management of UP Timisoara and TU München for identification of future collaboration directions, students exchange in the framework of Erasmus +: a PhD student from UP Timisoara will carry on a research stage at TU München, two final year bachelor students (from Mechanical Engineering and Medical Engineering) performed a practical training in order to finalize their licenses.

Also, Prof. Dr.-Eng. Ewald Werner will donate to the Library of UPT the collection of international journal Materials Science and Engineering: A Structural Materials: Properties, Microstructure and Processing, whose publisher he is.

For the entire scientific, didactic and managerial activity, for the sustained collaboration with our university, and for the outstanding results reflecting this activity, the conclusion unequivocally and unanimously reached by all members of the committee that analysed this activity, to confer the title of Doctor Honoris Causa of the University Politehnica Timisoara to Prof. Dr. Eng. Ewald Werner from Technical University of München, Germany.

HONORARY PROFESSOR

Professor Eng. Vladimir KATIĆ, PhD University of Novi Sad, Serbia

Professor Vladimir KATIĆ is born in 1954 and graduated at the Faculty of Electrical Engineering, part of the University of Belgrade, Serbia, in 1981. In the year 1991 he obtained the PhD degree in the field of Electrical Engineering at the University of Belgrade. transportation and standardization in electrical engineering.

The university career he started as member of the teaching and research staff of the University of Novi Sad, Serbia, at the Department of Power, Electronics and Telecommunication Engineering of the Faculty of Technical Sciences.

All along his university career Professor Eng. Vladimir KATIĆ contributed with passion and Excellency, teaching in the domain of electrical engineering many courses, and he passed, step by step, all qualification degrees as member of teaching staff, as a result of his activity in the home university, but also by performing in cooperation with several European universities.

During the professional career Professor Vladimir KATIĆ has a strong collaboration with de UPT, mainly with the Faculty of Electrical and Power Engineering.

The main fields of scientific and research interest of Prof. Katić are power quality, renewable energy sources, power electronics, electric vehicles and transportation and standardization in electrical engineering.

Taking into account the entire activity, in teaching, scientific research and international cooperation, the Senate of Politehnica University Timisoara has decided to confer the academic title Honorary Professor of Politehnica University Timișoara to Professor Eng. Vladimir KATIĆ, PhD from University of Novi Sad, Serbia.



HONORARY PROFESSOR

Prof. Eng. Aurel CÂMPEANU, PhD
University of Craiova, România

Professor Aurel Câmpeanu is born in 1935 at Calafat, Romania and graduate of the Faculty of Electrotechnics of Craiova in 1958.

After his graduation, he worked for a short time at the Electroputere plant, after which, from 1961 to 1972, he started his teaching career at the Polytechnic Institute of Timisoara (today -Politehnica University Timisoara), where he obtained the title of engineer in 1969, under the leadership of the Academician Toma Dordea, with the thesis "The study of two mechanically coupled synchronous machines, connected to the common network"

Professor Aurel Câmpeanu returned to the University of Craiova, the Faculty of Electrical Engineering, becoming a doctoral supervisor in 1988 (he coordinated 25 doctoral theses), he was dean of the faculty and rector of the university, member of the Academy of Technical Sciences, Doctor Honoris Causa of many universities.

Professor Câmpeanu is an internationally renowned specialist in the field of electric cars, he has taught at the national premiere the course on Dynamics of electric cars, he coordinated several international grants and has three patents.

Professor Aurel Câmpeanu has always been linked to Timisoara, "the city of his youth", as he calls it, with nostalgia. The collaboration with the Politehnica University Timisoara continued after leaving for Craiova.

In order to reward the efforts, achievements and the entire activity the Senate of the Politehnica University Timisoara has decided to grant the distinguished professor the academic title of Honorary Professor of Politehnica University Timișoara to Prof. Eng. Aurel CÂMPEANU, PhD from University of Craiova, România.



HONORARY PROFESSOR Prof. Eng. Christoph GEHLEN, PhD Technical University of München

Professor Eng. Christoph GEHLEN is born in 1966, he graduated Bonn University, Faculty of Physics, Chemistry and Mineralogy (1989) and RWTH Aachen University (1995). He went on to complete his doctorate at RWTH Aachen in 2000. After that, he founded an international engineering firm in München along with two partners.

After accepting a Chair at the University of Stuttgart (2006), he joined at Technical University of München in 2008. In 2011 was elected member of the Department Council of Civil, Geo and Environmental Engineering, and in 2016 was elected Dean of Study Department Council of Civil, Geo and Environmental Engineering.

Professor Gehlen is a member of several panels and committees in Germany and around the world. His researches are in the field of construction materials. The objective of his work is to find ways to describe and predict the lifespan of mineral and metallic building materials taking exposure into consideration.

Professor Gehlen has received many recognitions: Prize for Excellence in Teaching, Bavarian State Ministry of Science and the Arts (2018); Fellowship for Innovation in Academic Instruction, Stifterverband für die Deutsche Wissenschaft, Joachim Herz Stiftung (2012/2013); Rüscher Research Prize, awarded by Deutscher Beton- und Bautechnik-Verein e.V. (2001); Readymix Promotional Prize, awarded by Readymix Deutschland AG (2000); Thyssen-Hünnebeck Award, Thyssen Hünnebeck Foundation (1995).

In order to reward the efforts, achievements and the entire activity of Professor Gehlen, the Senate of the Politehnica University Timisoara has decided to grant the distinguished professor the academic title of Honorary Professor of Politehnica University Timișoara to Prof. Eng. Christoph GEHLEN, PhD from Technical University of München.



HONORARY PROFESSOR Prof. Eng. Zoltán RAJNAI, PhD Óbuda University, Hungary

Professor Zoltán RAJNAI is born in 1962. Dr. Rajnai received education from the High School at the Hungarian Defense Forces (1981-1985), the Military Academy (1990-1993), the Doctoral School on Military Sciences (1997-2000), and the Joint Security College- Paris, France (2003-2004).

Dr. Zoltán Rajnai is currently the National Cyber Coordinator of Hungary, Hungary's Representative to ENISA and professor at the Óbuda University. Previously Dr. Rajnai served as Colonel in Hungarian Defense Forces (1981-2013) and was professor at the National Defense University in the field of Information, info-communication, and telecommunication systems (1993-2013). Since 2013, Dr. Rajnai also is the Dean of faculty of Mechanical and Safety Engineering, Head of Doctoral School on Safety and Security Sciences with main responsibilities in the field of Cyber Security, Information Security, info-communication, and telecommunication systems.

Professor Rajnai has received many recognitions: Zrínyi Ring - for her excellent teaching work, French "Gold Medal of Merit for National Defense" (2005) for his work in Franco-Hungarian military higher education cooperation, Minister of Defense of the French Republic; and Knight of the French National Order of Merit (2011) for his international work in higher education and scientific research, President of the French Republic.

Between 2007 and 2011, he was Program Director for the Hungarian-French International-Scientific Project COMMIT, and at the same time was a guest lecturer at the Military Technical College in Rennes, France.

Since 2012 he has been the president of Tivadar Puskás News Companion Society.

In order to reward the efforts, achievements and the entire activity of Professor Rajnai, the Senate of the Politehnica University Timisoara has decided to grant the distinguished professor the academic title of Honorary Professor.



HABILITATION THESIS

EVOLUTION OF HABILITATION THESIS IN UPT 2015 - 2019

Habilitation (from Latin *habilis* "fit, proper, skillful") is the highest academic qualification a scholar can achieve by his or her own pursuit.

In this chapter we present the habilitation thesis supported by teachers from Politehnica University Timisoara, both at UPT and, also, at other universities.

The habilitation thesis are presented in chronological order, according to institution where they were sustained.

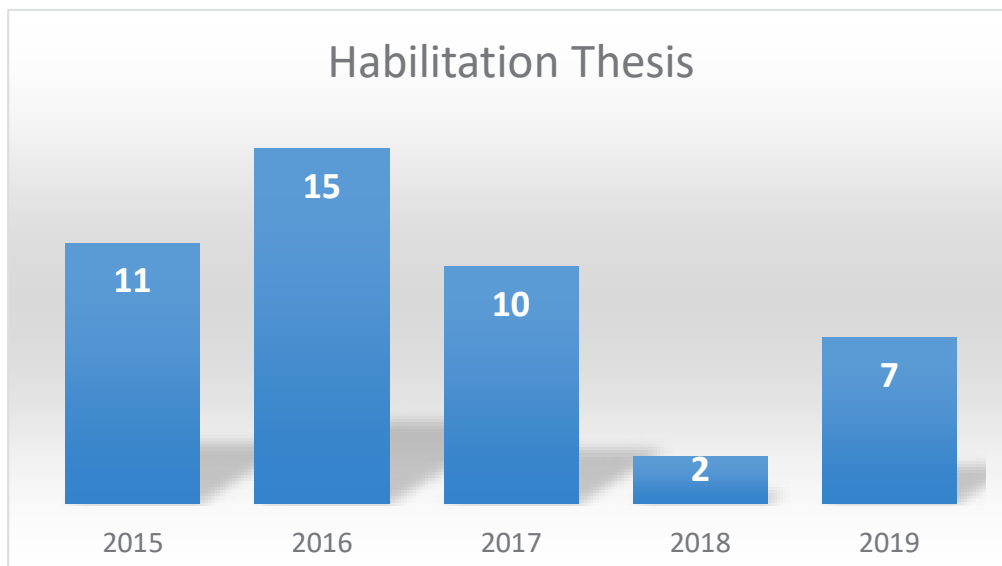

THE STAGING BUILT PROPERTY

Author: Ileana Maria KISILEWICZ

Abstract

The habilitation thesis reflects the topics and research areas covered after completing PhD studies, refined in terms of teaching experience and practical professional experience in the conservation of buildings field. Research, design and implementation of theories and conclusions both in professional practice and in the teaching activity took place mainly by overlapping several levels in an interdisciplinary approach.

The thesis topic is a favorite topic of those architects, planners and even restaurateurs which was constantly proposed by Charters of 20th and 21st century. For over 50 years in Europe discussion regarding The staging built property, represents a concept that translates a renewed vision on cultural property, it considered the heritage not only as preserved and contemplated but a dynamic reality, capable of carrying an active role in the contemporary world. This new approach on the past involved the sphere of artistic creation, reshaping the relationship between old and new: from a predetermined unique reality and sometimes from untouchable and unexpected side. Enabling us to discover that heritage building representing the past as a living material which became a creative stimulus of fruitful dialogue. Contemporary intervention being in direct contact with a historical context is daily practice in urban areas, rural areas and remote human settlements and therefore the intervention is practiced using the instruments of both fields: architecture and the visual arts.

The first chapter covers the most important scientific results obtained in the three main activities: research, design, practical and teaching – from the first books, chapters in edited volumes, visibility and academic impact achievement, outstanding results obtained as a result of large-scale projects of restoration as well as the results of comparative research on the work of Romanian and Italian architects in both countries, to the considerations on analytical research on restoring surfaces of architecture and efficiency of applying the provisions of urban characteristics of interventions in protected construction areas of Bucharest in the first decade of the 21st century.



The second chapter summarizes a selection of restoration projects, experiences of direct restoration of stone as reference material concerns-improvement of about 21 years, and the successful design project for exhibition in 2014 at the Venice Architecture Biennale.

Chapter three covers academic and teaching achievements justifying academic experience gained, the ability to lead research, ability to work in extensive interdisciplinary teams, experience of teaching in different faculties, the ability to guide students and young researchers.

The full thesis at:

http://www.upt.ro/Informatii_teze-de-abilitare-sustinite_285_ro.html

Habilitation Commission

Prof.univ.dr.arh. - Cristian DUMITRESCU

Politehnica University Timișoara

Prof.univ.dr.arh. – Augustin IOAN

University of Architecture and Urbanism “Ion Mincu” București

Prof.univ.dr.arh. – Virgil POP

Politehnica University Cluj Napoca

RESEARCH AND CONTRIBUTIONS IN THE FIELD OF USING AND PRODUCTION OF ELECTRICITY

Author: Sorin Ioan DEACONU

Abstract

The habilitation thesis contains the following chapters: motivation, research directions, achievements, the scientific, professional and academic development plan, and finally the bibliography chapter. The first chapter, motivation, summarizes the didactic and research activity, the results obtained the cooperation with other universities and the expressed desire to continue the research in the field of electrical engineering at a higher level by obtaining the certificate of habilitation. In the second chapter the main directions of research are presented: industrial applications of AC electric drives, compensation of reactive energy and superior harmonics to strongly deforming electric consumers, axial electric drive systems for hybrid and electric vehicles, and energy conversion for adjustable wind or hydro applications. For each of the research directions listed, the main achievements are presented. The chapter of scientific, professional and academic achievements presents the activities carried out within each research direction and the main results obtained in a more detailed fashion.

The Research Direction on Industrial Applications of Variable Speed AC Drives is divided into four subchapters which present concerns regarding the reduction of the active electric energy consumption by using the variable speed, the controlled start of the electric drive systems, the production of electric power with variable asynchronous generators and the artificial load testing of the rotating electric machines. Among the great energy consumers we find the pumping and ventilation systems. Automating these systems and increasing their energy efficiency can be done with PLCs, static frequency converters, communication and data transmission systems. Applying different solutions in practice is a challenge for an engineer but also for a researcher in the field of machine systems and electric drives. Proposed and practiced applications are presented, but some of them are applied even after a long time because of the important investment effort required.

Another direction of research, detailed in six subchapters, is represented by axial synchronous machines (with an stator, two permanent magnets rotors and a single inverter for vector control of the both rotors speed) intended for electric hybrids or pure electric



vehicle applications. Constructive topology, circuit model, optimal design, control methods, and quasi 3D-FEM analysis were presented for validation of analytical data on machine torque developed. A new family of electric machines is proposed to improve the radial and axial dimensions, with high torque density and high efficiency. The torque capability of the machine with concentrated fractional stator windings and surface permanent magnets has been demonstrated. The last research direction approached in the habilitation thesis has as theme the theoretical and experimental study of the adjustable electric generators for wind or hydro applications.

Fifteen subchapters were presented for the homopolar and homo-heteropolar reactive synchronous generators with stator excitation and for the dual stator windings induction generator with the cage rotor.

The full thesis at:

http://www.upt.ro/img/files/2018-2019/doctorat/abilitare/Deaconu-Sorin/Rezumat_abilitare_Sorin_Deaconu_en.pdf

Habilitation Commission

Prof.univ.dr.ing. Vasile ȚOPA

Technical University of Cluj-Napoca

Prof.univ.dr.ing. Sorin Dan GRIGORESCU

University POLITEHNICA of Bucharest

Prof.univ.dr.ing. Sorin MUȘUROI

Politehnica University Timișoara

CONTRIBUTIONS TO DEVELOPMENT OF OPTICAL DESIGN IN MECHATRONIC APPLICATIONS

Author: Corina-Mihaela GRUESCU

Abstract

The first chapter, Basic optical design. Glass choice, offers a solution to the problem of choosing the suitable sorts of glass by means of stating mathematical criteria implemented in software application. The practical solutions, including aspheric surface use, provided by the application lead to high image quality for large apertures.

The second chapter refers to Optical engineering applied in laser machining. The first paragraph develops Optics optimization in laser spot radius minimization. The research provided original solutions for the expander and focusing objective (both diffraction limited). The second paragraph is dedicated to Experimental optimization of process parameters in laser cutting of polycarbonate gears. Fractional factorial experiments plans stated by Taguchi method and a specialized software proved to be quick, economic (only 40 samples needed for optimizing six parameters in two levels and one interaction) and very efficient.

The third chapter develops some aspects regarding the Document digitization. Two paragraphs are dedicated to Digitization Equipment and Techniques in Retrieval of Mechanism and Machine Science Resources and Interactive animation production by means of advanced image processing.

Design and assembling of the scanning equipment as well as the capturing, stocking and managing raw image files software were developed as original contributions. Beside documents, the library also displays physical demonstration models and mechanism descriptions. The physical working models of the mechanisms are digitally recorded as a sequence of images. With further handling steps, these image sequences are composed to interactive animations, available on DMG-Lib internet portal or downloaded as video files for local use.

The fourth chapter develops several applications, which implement Optical engineering in medical investigation. The first paragraph describes the Modeling of human spinal column and evaluation of



spinal deformities. A large number of numerical parameters were suggested for the description of the column's shape. A special software – INBIRE – was developed to work with the imaging system InSpeck.

The second paragraph covers the subject Experimental method for evaluation of spinal column deformation, based on data acquired with a system of accelerometers and advanced image processing. The goal of the study is to develop a method to record the Cobb angles variation, which should serve to the evaluation of the efficiency of the therapy exercises.

The full thesis at:

http://www.upt.ro/img/files/2018-2019/doctorat/abilitare/Gruescu_Corina/Corina_Gruescu_Rezumato_abilitare_en.pdf

Habilitation Commission

Prof. dr. ing. Dan Silviu MÂNDRU

Technical University of Cluj-Napoca

Prof. dr. ing. Cătălin ALEXANDRU

Transilvania University of Brașov

Prof. dr. ing. Ioan DOROFTEI

Technical University "Gheorghe Asachi" of Iasi

RESEARCH ON THE ANALYSIS AND OPTIMIZATION OF OPERATING REGIMES OF POWER TRANSMISSION AND DISTRIBUTION NETWORKS

Author: Adrian PANĂ

Abstract

Both the didactic component of the candidate and its research activities took place in two closely related areas, namely the electrical transport and distribution networks and the power quality, fields of major importance belonging to an integrating domain - electrical power engineering. The most important results of the candidate's research work, obtained on the research topics defined as representative, were grouped into four thematic areas of major importance, as follows:

1. Transfiguration of electrical distribution networks.
2. Balancing the loads of electrical distribution networks by unbalanced reactive shunt compensation.
3. Evaluation of impedance unbalance in three-phase electrical networks and their effects.
4. Evaluation of harmonic impedances in harmonic polluted electrical networks and their effects.

The study of the harmonic impedance has an important weight in the research activity, being oriented towards:

- Using the harmonic impedance of the network in the study of capacitive shunt compensation in the presence of non-sinusoidal regime.
- Analytical and numerical determination of the harmonic impedance seen in the buses of an electrical distribution network.
- Analytical and numerical determination of harmonic impedance seen in the sections of a three-phase line.
- Experimental determination of the harmonic impedance seen in the buses of an electrical network.

Another component of the author's research activity is the participation in solving over 20 research grants won in national competitions, research contracts or consultancy with energy companies or training grants, out of which six he was the project director:

- 7 research/ consultancy contracts with a value of at least 2000 € - out of which 3 was the project director;
- 6 national grants/projects won by competition - out of which 2 was project director.



The results of the candidate's research activity have been brought to the attention of national and international academic and scientific community, through articles published in journals or conferences proceedings. For the period covered by the habilitation thesis, the candidate has published 81 articles, out of which 36 articles he is the first author or main author. The most important are:

- 4 in journals ISI indexed;
- 2 in journals indexed in other international data bases (IDB);
- 19 to ISI international conferences;
- 5 to IDB international conferences.

The full thesis at:

http://www.upt.ro/img/files/2018-2019/doctorat/abilitare/Pana-Adrian/Adrian_Pana_Rezumat_abilitare_en.pdf

Habilitation Commission

Prof.dr.ing. Mihai GAVRILAȘ

Technical University „Gheorghe. Asachi” of Iași

Prof.dr.ing. Constantin BULAC,

Politehnica University of Bucharest

Prof.dr.ing. Ștefan KILYENI,

Politehnica University Timișoara

ENTREPRENEURSHIP, EDUCATION AND SUSTAINABLE MANAGEMENT

Author: Matei TĂMĂȘILĂ

Abstract

This habilitation thesis reveals the capabilities and didactic and research performance of the candidate, developed after the public defending of the PhD thesis until now. The habilitation thesis focuses mainly on those achievements that attest to the author's ability to conduct scientific research activities in Engineering and Management with applications in Entrepreneurship, Education and Sustainable Management.

The present thesis is structured on three major and topical directions in the literature: Entrepreneurship and entrepreneurship education; Microeconomic and macroeconomic influences at national and global level; Education and Sustainable Development.

The first direction presents the concept of entrepreneurship, its importance and its associated imperatives. Systematizing the main researches on entrepreneurial theories represents a first step, a first attempt to authorize the attempts to understand the mechanism, the capabilities and resources needed for its support and development. There are a number of studies on focused economies, transition economies and innovation-focused economies. At the same time, facilitators, and actors for entrepreneurship: national, regional and global are presented.

As the educational approach is currently centered on the student, the research addresses the directions, objectives and motivating factors of the student-centered university education. Assessing the competitiveness of higher education is an important component of entrepreneurial education. A number of conditions are identified for increasing the competitiveness of Romanian higher education. Secondly the work addresses to the attitude of active knowledge and its impact on entrepreneurial activity in Europe. Various literature reviews, assessments of entrepreneurial activity in Europe are presented. At the same time, an analysis of the business incubator in Romania is carried out with details, benefits, implications and developed opportunities.



The next direction addressed in the thesis is assessments and analyzes of micro- and macroeconomic influences. These influences are directly tangential to the entrepreneurial domain. These influences help leaders and entrepreneurs in developing and conducting business activities, providing them with milestones in developing sustainable strategies.

The third direction addressed in this thesis is education and sustainable development. Sustainability is an intense direction addressed at national and international level. From the perspective of entrepreneurship, sustainable development is a challenge that most entrepreneurs are addressing. The research also addresses the importance of education in sustainable development. Closely related to education are business activities related to renewable energies, waste collection, loss reduction and other related approaches.

The second part of the habilitation thesis shows the development perspectives. These perspectives are presented in the three directions: didactic, research and administrative.

The full thesis at:

http://www.upt.ro/img/files/2018-2019/doctorat/abilitare/Tamasila_Matei/Matei_Tamasila_Rezumat_Abilitare_en.pdf

Habilitation Commission

**Prof.univ.dr.ing. Anca DRĂGHICI -
Politehnica University Timișoara**

Prof.univ.dr.ing. Laura BACALI

Technical University of Cluj-Napoca

Prof.univ.dr.ing. Lucian Ionel CIOCA
"Lucian Blaga" University of Sibiu

LAYERED LDPC DECODING ARCHITECTURES: BRIDGING THE GAP FROM ALGORITHMS TO IMPLEMENTATIONS

Author: Oana AMARICĂI-BONCALO

Abstract

This thesis presents the research and academic achievements during the 2014–2019 period. Modern communication and storage standards require efficient Forward Error Correction (FEC). Due to their excellent error correction capability, Quasi-Cyclic Low-Density Parity-check codes (QC-LDPC) are a class of codes employed in wireless standards, digital video broadcasting, and non-volatile semiconductor memories.

This fact prompted the research direction we have pursued during the last 5 years, mainly the study of QC-LDPC decoder architecture trade-offs and optimizations. More specifically, within the framework of the project DIAMOND - Message Passing Iterative Decoders based on Imprecise Arithmetic for Multi-Objective Power-Area Delay Optimization -, in collaboration with researchers from CEA-LETI Grenoble (dr. Valentin Savin), and ENSEA Cergy-Pontoise (prof. David Declercq), we have tried to exploit the advantages of implementing imprecise operations in Low-Density Parity-Check (LDPC) decoder architectures, in order to optimize the cost/area/power consumption. The original project goals – to develop hardware architectures that use imprecise arithmetic – have been largely expanded due to the very favorable research results. The contributions presented in this thesis closely follow the DIAMOND project.

A key contribution of this related to the data hazards due to the late update effect caused by memory access time and pipeline. Furthermore, if implementation-wise, the message memory uses banks made of Static Random Access Memory (SRAM) blocks, the access patterns according to the code graph also introduce data conflicts.

We approached this problem from two directions (1) A set of offline algorithms has been proposed such that an almost optimum message memory mapping and access scheduling that avoid RAW hazards is generated. (2) Architecture aware code design for application where the LDPC code is not fixed. The proposed algorithm builds on



a well known construction algorithm - Progressive Edge Growth (PEG). The proposed architecture aware PEG (AL-PEG) extends the original PEG by adding new constraints related to pipeline and message memory mapping.

The full thesis at:

http://www.upt.ro/Informatii_teze-de-abilitare-sustinite_285_ro.html

Habilitation Commission

Prof. dr. ing. Adina Magda Florea

University Politehnica Bucharest

Prof. dr. ing. Sergiu Nedevschi

Technical University of Cluj-Napoca

Prof. dr. ing. Mircea Popa

Politehnica University Timișoara

DEPOSITION AND REMELTING METHODS OF CORROSION AND WEAR RESISTANT COATINGS

Author: Ion-Dragoș UȚU

Abstract

The habilitation thesis entitled “Deposition and remelting methods of corrosion and wear resistant coatings” presents a synthesis of the main research results obtained by the candidate during the years 2005–2019 in the field of Materials Science and Engineering. The work approaches as the main direction of the research, the processing and characterization of the functional layers resistant to corrosion and wear by using modern techniques specific to surface engineering.

The thesis is structured in two parts and three distinct chapters, the first part being regarding the main scientific, professional and academic contributions, and the second part, presenting the evolution of the career and the perspectives of personal development. There are presented the main problems that arise in the components of the installations and equipment that work in the industrial field. During operation, they are subjected to corrosion and wear phenomena that can lead to their premature degradation. To improve the functional characteristics and increase the operating life of these components various deposition techniques (thermal spraying, laser cladding and weld deposition) and different categories of coatings are proposed.

It is highlighted the effect of surface irradiation with concentrated energy sources (laser, electron beam, WIG melting) on the microstructural and morphological characteristics of the thermally sprayed coatings. These materials, depending on the deposition process and the granulation of the depositing feedstock, have a non-homogeneous structure, with a certain degree of internal oxidation and porosity which can sometimes produce phenomena of spallation and delamination of the coating from the substrate. By using local treatments, the surface layer can be completely or partially remelted. In general, the purpose of applying these treatments is to improve surface characteristics by increasing wear, erosion and corrosion resistance.



In the last part of the habilitation thesis, the plans for the evolution and development of the professional career are presented.

The full thesis at:

http://www.upt.ro/img/files/2019-2020/doctorat/abilitare/UTU_Ion-Dragos/Rezumat_abilitare_Utu_Dragos_en.pdf

Habilitation Commission

Prof. dr.ing. Liviu Marșavina

Politehnica University Timisoara

Prof. dr.ing. Mircea Horia Țierean

Transilvania University of Brasov

Prof. dr.ing. Corneliu Munteanu

Technical University “Gheorghe Asachi” of Iasi

PhD THESIS

EVOLUTION OF PhD THESIS DEFENDED IN UPT 2015 - 2019

PhD students of UPT are those with a high degree of personal motivation that stems from their natural curiosity and love of intellectual pursuits. It is expected that after they obtain their degree they will metamorphose into scholars for whom also the temptation of researching new and exciting subjects is irresistible, or at least preferable to all other choices.

Doctoral programs usually encompass intensive training in research methods, including interviewing, surveys, questionnaires, clinical trials and laboratory experiments; later, those skills are put into practice when the doctoral candidate conducts fieldwork for his dissertation. Skills gained in qualitative and quantitative research methodology and statistical analysis are transferable to non-academic research environments, particularly for industrial research. In addition, employers outside of academia seek individuals with sound research skills to carry out projects at think tanks and research institutes in both the private and government sectors.

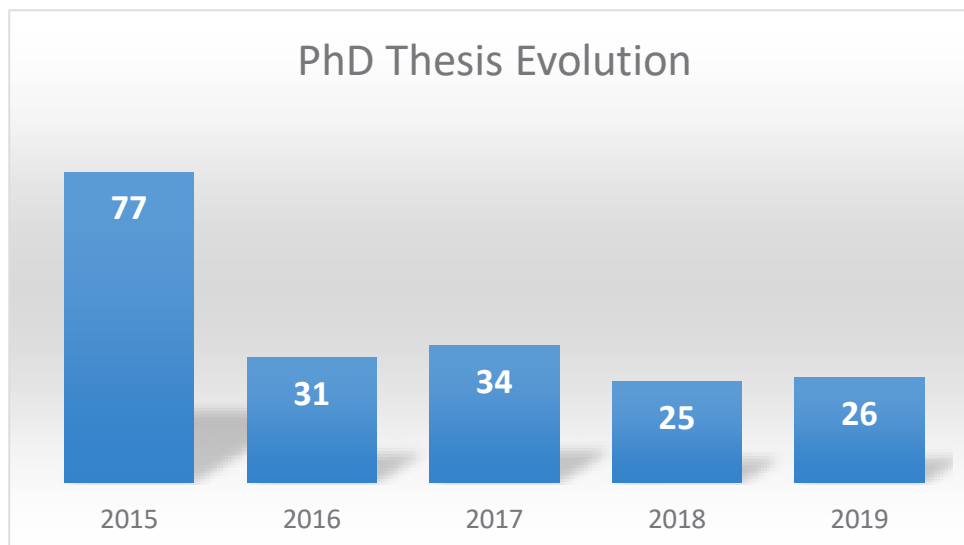

In this chapter we present a list of the PhD Thesis defended in Politehnica University Timisoara during 2019.

Architecture

Ovidiu MIȚȘA
PhD adviser prof. S.M. BICA

Studii despre percepția spațiului construit. Fotografia ca instrument de reprezentare mentală a arhitecturii
(Studies on the perception of built space. Photography as instrument for mental representation of architecture)

Dan IDICEANU-MATHE
PhD adviser prof. T. O. GHEORGHIU

Georges Cristinel - Un arhitect care face tranziția
(Georges Cristinel - The Architect of the Transition)

Systems Engineering

Artur Miklos KUCZAPSKI
PhD adviser prof. G. D. ANDREESCU

Analiza percepției auzului la persoane cu implanturi cohleare - Model de simulare a percepției auditive
(Understanding Hearing through Cochlear Implants - A Simulation Model of the Hearing Perception)

Computers and Information Technology

Renata-Graziela BOAR
PhD adviser prof. H. CIOCĂRLIE

Rețele complexe cu aplicabilitate în analiza financiară și economică
(Complex networks with applicability in financial and economic analysis)

Marian Ștefan NEICU
PhD adviser prof. G. G. SAVII

Metode și tehnici de proiectare a sistemelor informatice destinate mediului de afaceri
(Methods and techniques for designing businesses information systems)

Chemical Engineering

Diana-Maria APARASCHIVEI
PhD adviser prof. F. PETER

Sinteza, caracterizarea și degradarea unor noi oligoestere din materii prime regenerabile
(Synthesis, characterization and degradation of new oligoesters from renewable raw materials)

Andreea-Emeline GABOR
PhD adviser prof. C. M. DAVIDESCU

Materiale avansate modificate chimic prin funcționalizare cu aplicații în protecția mediului
(Advanced materials chemically modified through functionalisation with application in environmental protection)

Chemistry

Eniko BEREI
PhD adviser prof. M. ȘTEFĂNESCU

Noi metode de obținere a cromiților de cupru și cobalt nedispersați și dispersați în matrice de silice
(New methods for obtaining copper and cobalt chromites undispersed and dispersed in silica matrix)

Civil Engineering and Building

Ioan CIORTEA
PhD adviser prof. T. E. MAN

Interecțiunea teren-structură pentru construcțiile hidrotehnice, hidroedilitare și hidroameliorative
(Structure interaction for hydrotechnical, water and sewer systems and hydroameliorative structures)

Civil Engineering

Mariana TĂMAȘ (GÎRU)
PhD adviser prof. T. E. MAN

Aspecte privind dezvoltarea durabilă a zonei Anina-Bozovici
(Structure interaction for hydrotechnical, water and sewer systems and hydroameliorative structures)

Electronic Engineering Telecommunications and Information Technologies

Ionel Romeo PETRUȚ
PhD adviser prof. M. E. OTEȘTEANU

Rețele eterogene în LTE
(Heterogeneous Networks in LTE)

Mircea GURBINĂ
PhD adviser prof. D. LASCU

Stabilitate, bifurcație și haos la convertoare DC-DC în comutație
(Stability, bifurcation and chaos in DC-DC switching converters)

Andrei-Marius SILAGHI
PhD adviser prof. A. DE SABATA

Contribuții la evaluarea și ameliorarea emisiilor și imunității în compatibilitatea electromagnetică a autovehiculelor rutiere
(Contributions to the evaluation and improvement of emissions and immunity in electromagnetic compatibility of road vehicles)

Laszlo MOLNAR
PhD adviser prof. A. GONTEAN

Contribuții la modelarea, simularea și emularea Circuitelor Integrate Dedicate controlului inteligent al pompelor de combustibil de înaltă presiune din domeniul automotive
(Contributions to Modeling, Simulation and Emulation of Application Specific Integrated Circuits for intelligent control of High Pressure Fuel Pumps in the automotive field)

Power Engineering

Cosmin Gabriel OROS
PhD adviser prof. Ș. Kilyeni

Optimizarea funcționării rețelelor de distribuție utilizând tehnici de inteligență artificială
(Distribution network operation optimization using artificially intelligence techniques)

Engineering and Management

Bianca CÎRJALIU
PhD adviser prof. A. DRĂGHICI

Analiza ergonomică a sistemelor de fabricație Lean
(Ergonomic analysis of lean manufacturing systems)

Aida Sorina SZILAGYI
PhD adviser prof. M. L. MOCAN

Abordări inovative în aplicarea metodelor de eco-eficientizare în companii
(Innovative approaches in applying eco-efficiency in companies)

Marian Constantin VASILE
PhD adviser prof. M. L. MOCAN

Model de dezvoltare a orașelor și regiunilor inteligente în România
(Development model for smart cities and regions in Romania)

Mechanical Engineering

Vlad MARȚIAN
PhD adviser prof. M. NAGHI

Contribuții privind cercetări ale schimbătoarelor de căldură cu suprafețe ondulate cu capete drepte și suprafețe cu generatori de turbulențe
(Contributions regarding researching to straight-ended corrugated heat exchangers and turbulence-generating surfaces)

Materials Engineering

Traian Aurel BENA
PhD adviser prof. I. MITELEA
PhD adviser prof. I. BORDEAȘU

Influența microstructurii asupra rezistenței la eroziune prin cavitație a fontelor cu grafit nodular
(Influence of the microstructure on cavitation erosion resistance of cast iron with nodular graphite)

Dumitru Sorin URLAN
PhD adviser prof. I. MITELEA

Contribuții privind procesul de sudare prin topire a oțelurilor inoxidabile Duplex
(Contributions on the fusion welding process of Duplex stainless steels)

Corneliu BIRTOK BĂNEASĂ
PhD adviser prof. T. HEPUȚ

Cercetări privind utilizarea materialelor avansate în optimizarea procesului de admisie a motoarelor cu ardere internă
(Research regarding the use of advanced materials for optimizing the intake process for internal combustion engines)

Norbert KAZAMER
PhD adviser prof. V. A. ȘERBAN

Dezvoltarea, optimizarea și caracterizarea unor straturi de NiCrBSi-TiB₂ pulverizate termic cu flacără și retopite în cuptorul cu vid
(Development, optimization and characterization of NiCrBSi-TiB₂ vacuum fused flame-sprayed coatings)

Cristina-Daniela PĂCURAR (DÎMPU)
PhD adviser prof. T. HEPUȚ

Cercetări privind influența structurii încărcăturii metalice asupra reducerii consumurilor specifice și a gradului de poluare la oțelăriile electrice
(Research regarding the influence of the metallic charge upon reducing the specific consumption and the degree of pollution at electric mills)

Paula SVERA (IANASI)
PhD adviser prof. V. A. ȘERBAN
PhD adviser prof. N. VASZILCSIN

Materiale pe bază de Cd_xZn_{1-x}S utilizate ca fotocatalizatori activi în vizibil pentru producerea hidrogenului
(Materials based on Cd_xZn_{1-x}S used as visible light active photocatalyst for hydrogen production)

Industrial Engineering

Theoharis BABANATSAS
PhD adviser prof. D. ȚUCU

Integrarea elementelor de robotică în realizarea unui sistem pentru recoltarea măslinelor
(Integrating robotics elements into a system for harvesting olives)

SCIENTIFIC CONFERENCES

EVOLUTION OF SCIENTIFIC CONFERENCES 2015 - 2019

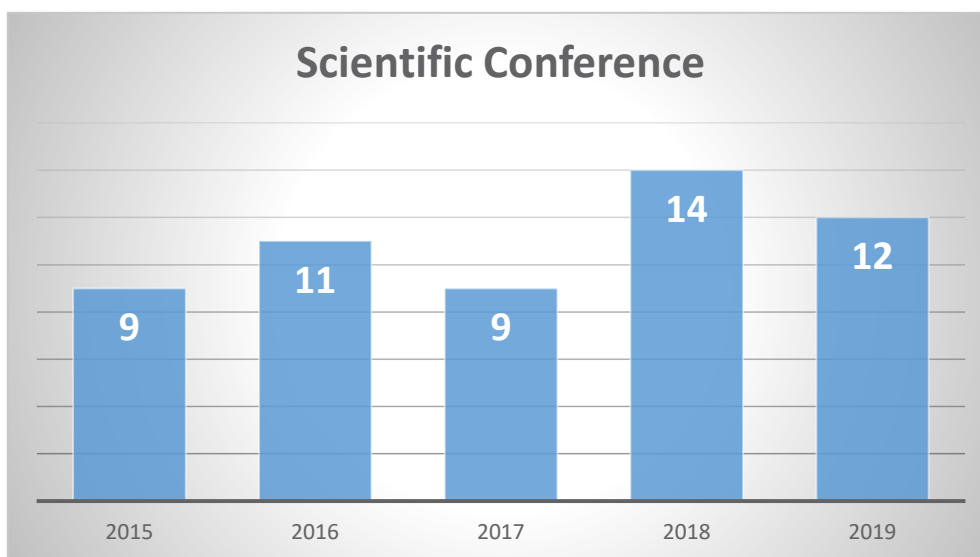

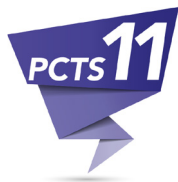

Professional Communication and Translation Studies: Language and Communication in the Digital Era: Challenges for Researchers, Teachers and Practitioners

April 4 - 5, 2019, Timișoara, Romania

Organizer: Department of Communication and Foreign Languages, Politehnica University Timisoara

<http://sc.upt.ro/ro/home-pcts>

The international conference Professional Communication and Translation Studies has been organized by the Department of Communication and Foreign Languages since 2001. The conference aims to develop the exchange of ideas on the following topics:

- Communication and public relations: theoretical and didactic problems and solutions
- Linguistic insights into professional communication
- Translation theory and translation didactics: their roles in communication
- Foreign language teaching

Publication of papers: Professional Communication and Translation Studies (ISSN 2065-099X) is an international peer-reviewed conference proceedings published annually in one volume. The proceedings include selected papers presented at the International Conference on Professional Communication and Translation Studies and are divided into four main sections.

Professional Communication and Translation Studies is published by the Department of Communication and Foreign Languages, Politehnica University of Timisoara, Romania, and is included in the following databases: CEEOL, EBSCO – Communication and mass media complete, Index Copernicus, Google Scholar, MLA, ULRICH'S, Scipio and WorldCat.

Open Access Policy: Professional Communication and Translation Studies provides immediate open access to its content on the principle that making research freely available to the public supports a greater global exchange of knowledge. Professional Communication and Translation Studies is an Open Access journal which means that its entire electronic content is freely available without charge to the user or his/her institution. Users are allowed to read, download, copy, distribute, print, search, or link to the full texts of the articles, or use them for any other lawful purpose, without asking prior permission from the publisher or the author. This is in accordance with the BOAI definition of Open Access.



Building Services and Environmental Comfort (ICCA 2019)

April 12, 2019, Timișoara, Romania

Organizers: AIIR - Romanian Association of Building Services;
Politehnica University Timișoara - Civil Engineering and Installations Department;
in association with REHVA, Danube ASHRAE Chapter, Research Center of Installations,
Electrical Installations and Automation Society Romania

<http://www.aiir-timisoara.ro>

The Future, being a concern for everyone, led to the organization of the 28-th Conference "Building Services and Environmental Comfort" with theme "Contribution of specialized young people to construction installation" to be dedicated to those who "come" to future specialists-today students of all degrees-from country and abroad. Have published in volume of works, students, master students and PhD students as sole authors. Professors were be nominated as coordinators rather than authors.

The essential issues of human existence, such as environmental protection, energy consumption reduction, environmental comfort, are found in the 23 papers of the conference volume as well as in the 14 scientific papers presented by the country's specialists and foreigners in the plenary.

Topics: ambient comfort, environmental protection, HVAC systems, energy efficiency, renewable energy, natural resources, issues in facilities management and marketing.

At the conference proceedings have contributed 23 authors who addressed topics such as air and water quality, the use of unconventional energies (solar energy, wind energy, ground energy and energy of the environment), technical sustainability, but also the influence/importance of human action in contact with the environment. The young researchers concerns in close connection with the future work/activity, led to the elaboration of valuable works, with current themes and personal contributions to solve, gravitating in the fields of the primordial factors of life: air, water, heat, light, framing the perfect word "*Homo sanus in domo pulchra*".

Published papers by: The volume consisting of the conference's papers was published by Politehnica Publishing (ISSN: 1842-9491).



International Conference on Applied Sciences ICAS2019

May 9 - 11, 2019, Hunedoara, Romania

Organizers: Politehnica University Timișoara and Unieversity of Banja Luka in cooperation with Ministry for Scientific and Technological Development, Higher Education and Information Society of the Republic of Srpska, B&H Academy of Romanian Scientists Academy of Sciences and Arts of the Republic of Srpska, B&H Academy of Technical Sciences of Romania - Timisoara Branch General Association of Romanian Engineers - Hunedoara Branch and Association Universitaria Hunedoara
<http://www.fih.upt.ro/v4/ICAS2019/>

The conference has been focused on several fields of application, operation and influence of the applied sciences and technologies on industry.

Topics of the conference covers a comprehensive spectrum of issues from:

1. *Materials Science:* Metallic Materials, Composite Materials, Metal Alloys, Metallurgy, Heat Transfer, and others...
2. *Mechatronics:* Mechanical Engineering, Robotic Systems Engineering, Control Engineering, Reliability, and others...
3. *Electrical Engineering:* Circuits and Systems, Signal Processing, Electric Motors, and others...
4. *Computers Engineering:* Modeling and Simulation, Computational Methods in Engineering, Software Engineering, Data Bases, and others...
5. *Fundamental Sciences:* Numerical approximation and analysis, Interdisciplinary applications of mathematics and physics, Chemistry, and others...

Proceedings of ICAS2019 have been published in *Journal of Physics: Conference Series* vol. 1426 (2020).

IEEE 13th International Symposium on Applied Computational Intelligence and Informatics

SACI 2019 | May 29-31, 2019

IEEE 13th International Symposium on Applied Computational Intelligence and Informatics (SACI 2019)

May 29 - 31, 2019, Timișoara, Romania

Organizers: Óbuda University, Budapest, Hungary, Politehnica University Timișoara, IEEE Chapter of Systems, Many, and Cybernetics Society, Romania

<http://conf.uni-obuda.hu/saci2019/>

SACI 2019 has featured several kinds of presentations, including invited talks, contributed papers and posters. The outcome of SACI 2019 is a better understanding of some leading research areas, as already Computational Intelligence and Informatics have demonstrated.

SACI 2019 has welcomed papers on the following topics:

- Computational Intelligence
- Intelligent Mechatronics
- Systems Engineering
- Intelligent Manufacturing Systems
- Intelligent Control
- Intelligent Robotics
- Informatics.



“Acoustics and Vibration of Mechanical Structures” – AVMS-2019

May 30 - 31, 2019, Timisoara, Romania

- Organizers:** a) University Politehnica Timisoara – Acoustics and Vibration Laboratory
 b) Romanian Academy, Branch of Timisoara
 – Center for Fundamental and Advanced Technical Research
 c) Romanian Acoustical Society
 d) University of Nis, Serbia, Noise and Vibration Laboratory

www.mec.upt.ro/meca/avms/main.php

AVMS-2017 Conference was intended to serve as a platform for researchers, engineers, academicians, as well as professionals from industry to present and discuss their latest research results in the field of noise and vibration.

Topics:

- Noise and vibration control
- Noise and vibration generation and propagation
- Effects of noise and vibration
- Condition monitoring and vibration testing
- Nonlinear acoustics and vibration
- Analytical, numerical and experimental techniques for noise and vibration
- Modeling, prediction and simulations of noise and vibration
- Environmental and occupational noise and vibration
- Noise and vibration attenuators
- Regulations requirements and quality assurance systems related to acoustics/vibration
- Biomechanics and bioacoustics



The IX International Conference “Industrial Engineering and Environmental Protection”

October 3 - 4, 2019, Zrenjanin, SERBIA

Organizers: University of Novi Sad, Technical Faculty “Mihajlo Pupin”, Zrenjanin, SERBIA, in cooperation with partners: University Politehnica Timisoara, Faculty of Engineering, Hunedoara, ROMANIA, University “St. Kliment Ohridski”, Technical Faculty, Bitola, MACEDONIA, “Aurel Vlaicu” University of Arad, Faculty of Engineering, Arad, ROMANIA, University of East Sarajevo, Faculty of Mechanical Engineering East Sarajevo, BOSNIA & HERZEGOVINA and University of Giresun, Faculty of Engineering, Giresun, TURKEY

<http://www.tfzr.uns.ac.rs/iizs/>

Industrial Engineering

- Mechanical Engineering
- Energetics And Process Technique
- Designing And Maintenance
- Oil And Gas Engineering

Environmental Engineering

- Health And Environmental Protection
- Environmental Management
- Occupational Safety

Publication of papers:

– Proceedings of INTERNATIONAL CONFERENCE INDUSTRIAL ENGINEERING AND ENVIRONMENTAL PROTECTION (9 ; 2019 ; Zrenjanin), ISBN 978-86-7672-324-9, published by University of Novi Sad, Technical Faculty “Mihajlo Pupin”, Zrenjanin, SERBIA (<http://www.tfzr.uns.ac.rs/iizs/files/IIZS%202019%20Proceedings.pdf>)

– Selected papers in ANNALS of Faculty Engineering Hunedoara – International Journal of Engineering, ISSN: 1584-2665, ISSN-L: 2601-2332, ISSN-L: 1584-2665, published by University Politehnica Timisoara, Faculty of Engineering, Hunedoara, ROMANIA, <http://annals.fih.upt.ro/>

– Selected papers in ACTA TECHNICA CORVINIENSIS – Bulletin of Engineering, e-ISSN: 2067-3809, published by University Politehnica Timisoara, Faculty of Engineering, Hunedoara, ROMANIA, <http://acta.fih.upt.ro/>



23rd International Conference on System Theory, Control and Computing (ICSTCC 2019)

October 9 – 11, 2019, Sinaia, Romania

Organizers: Faculty of Automation and Computers, Department of Automation and Applied Informatics and Department of Computers and Information Technology of Politehnica University Timisoara; Faculty of Automation, Computers and Electronics of University of Craiova; Faculty of Automatic Control and Computer Engineering of Gheorghe Asachi Technical University of Iasi; Faculty of Control Systems, Computers, Electrical and Electronics Engineering of “Dunarea de Jos” University of Galati

<http://stcc2019.cs.upt.ro/>

ICSTCC 2019 has featured several kinds of presentations, including invited talks, contributed papers, posters and special sessions. The outcome of ICSTCC 2019 is a better understanding of some leading research areas, as already System Theory, Control and Computing have demonstrated.

ICSTCC 2019 has welcomed papers on the following topics:

- Automation and Robotics: Linear and Nonlinear Control System Design, System Identification and Process Modeling, Robust and Adaptive Control, Robotics and Intelligent Control, Applications and Case Studies in Automation and Robotics, Embedded Systems;
- Computer Science and Engineering: Distributed Systems and Software Engineering, Databases, Systems of Programs and Expert Systems, Web services, Internet Security, Software Tools and Methods, Grid Computing, Artificial Intelligence, Computer Architectures;
- Electronics and Instrumentation: Modeling, Simulation and CAD Tools, Signal Processing and Communication Systems, Linear and Nonlinear Circuits and Systems, Evolutionary Electronics.

Publication of papers:

IEEE Xplore Digital Library, please visit <http://ieeexplore.ieee.org/search/searchresult.jsp?newsearch=true&queryText=ICSTCC%202019>



10th International Conference on Speech Technology and Human-Computer Dialogue - SpeD-2019

October 10 – 12, 2019, Timișoara, Romania

Organizers: University POLITEHNICA of Bucharest, Faculty of Electronics, Telecommunications and Information Technology, Politehnica University Timisoara, Faculty of Electronics, Telecommunications and Information Technologies, Institute for Computer Science – Romanian Academy, Iași Branch, Research Institute for Artificial Intelligence “Mihai Drăganescu” – Romanian Academy, Bucharest, **Under the Aegis of** Romanian Academy – Section of Information Science and Technology,

Technical sponsorship: IEEE and The European Association for Signal and Image Processing (EURASIP), <https://sped.pub.ro/>

“SpeD 2019” celebrates its 10th edition by extending the topics of interest from spoken language technology and human-computer dialogue towards broader, related domains: multimodal signal processing, biosecurity, human-robot interaction and embedded systems. Furthermore, “SpeD 2019” conference and international forum reflected some of the latest tendencies in machine learning for audio, speech, image and multimodal information processing, biometrics and security for IoT, intelligent robots and embedded systems. **Topics:** Speech Analysis, Representation and Models, Spoken Language Recognition and Understanding, Computational Resource Constrained Speech Recognition, Text-to-Speech Synthesis, Speech-to-Speech Translation, Affective Speech Recognition, Interpretation and Synthesis, Speaker Identification and Diarization, Neural Networks and Deep Learning for Speech and Speaker Recognition, Speech Enhancement, Natural Language Processing, Speech and Language Resources – Data Collection, Transcription and Annotation, Spoken Dialogue Systems, Speech Interface Design and Human Factors Engineering, Human-Computer Interaction, Speech Disorders and Voice Pathologies, Educational / Healthcare Applications, Assistive Technologies, Forensic Speech Investigations and Security Systems, Speaker Recognition in Biometric Systems and Security, Biosecurity in Man-Machine Interfaces, IoT Security, Speech Emotion Recognition – Technologies and Applications, Speech Interface Implementation for Embedded / Network-Based Applications, Audio-Visual Speech Processing, Multimodal Information Retrieval, Multivariate Information Analysis, Applications for Multimodal and Multimedia Processing, Compressed Sensing (for Speech and/or Image Processing), Intelligent Robots and Human-Robot Interaction, Cyber-physical Systems, Machine Learning Applications for Embedded Systems, Applications of Modeling, Simulation and Verification in Automotive.

Publication of papers: The series of “SpeD” conferences is sponsored by IEEE and EURASIP. As all previous editions since 2009, “SpeD 2019” Proceedings will be indexed by the IEEE Xplore and by Thomson Conference Proceedings Citation Index.



The 9th International Conference on Energy and Environment CIEM 2019

October 17 - 18, 2019, Timișoara, Romania

Organizers: The Academy of Romanian Scientists,
University POLITEHNICA of Bucharest,
Politehnica University Timisoara,

in partnership with

World Energy Council – Romanian National Committee.

<http://ciem.energy.pub.ro/>

The aims of CIEM is to respond to challenges in the rapidly developing fields of Power Engineering and Environmental Engineering, and to inspire both research studies and practical applications by promoting interaction among scientists from universities, research institutions, and industry. Like the previous events, the conference will provide an ideal venue for the development of new partnerships. Therefore companies, institutes and universities are invited to participate to CIEM 2019!

Topics:

- Environmental Impact,
- Smart Cities,
- Renewable Energies,
- Hydro Power Engineering,
- Nuclear Power Engineering,
- Power Systems & Smart Grids,
- Energy Efficiency,
- Fluid Mechanics and Applications,
- Fossil Fuels Clean Technologies,
- Digitalization in Energy Systems.

Published papers by: All presented papers will be submitted for publication in IEEE Xplore and for indexing in ISI Web of Science and SCOPUS.



Circular economy in the water sector

October 17 - 19, 2019, Timișoara, Romania

Organizers: Aquademica,
Aquatim Water Company,
Romanian Water Association,
Politehnica University Timișoara

<http://conferinta.aquademica.ro/>

The conference will focus on catalyzing and involving stakeholders in the implementation of circular economy measures in the water sector. In recent years, increasing the water scarcity due to urbanization or climate change, has sometimes forced water companies to take measures to rationalize consumption or to supply water according to a schedule.

This practice, however, influences living standards, especially in large cities.

New ideas and innovations are therefore welcomed in the arena of the water sector.

Publication of papers:

Scientific Bulletin of the POLITEHNICA University of Timisoara



SIM 2019 : 15th International Symposium in Management

October 25 - 26, 2019, Timisoara, Romania

Organizers: Politehnica University Timișoara ,
West University of Timișoara

<http://sim2019.eu/>

The conference aims to bring together academics, professionals, and students in order to discuss the challenges that management had to deal with during the economic crisis and with which it has been dealing with ever since. Our purpose is to address specific questions, such as the role of management in a rapidly-changing environment, the key management problems that must be addressed and solved using particular methods and techniques, while considering the threats and opportunities that appear in this dynamic period of time.

Conference topics:

- management of innovation,
- business process management,
- entrepreneurship and innovation,
- financial management and financial governance,
- strategic management,
- change management,
- supply chain and operations management,
- sustainable management,
- the economics of small and medium-sized enterprises,
- third sector organisations management.

Published papers by:

The accepted papers will be published by Springer Proceedings in Business and Economics (ISSN: 2198-7246).

The publication is currently in process and the publisher expects the papers to be published by April 2020.

The XXI Symposium

Young People and
Multidisciplinary Research

1SYPMR 2019

Romania - Serbia - Hungary

The XXIst Symposium "Young People and Multidisciplinary Research"

November 21 - 22, 2019, Timișoara, Romania

Organizers: Association for Multidisciplinary Research (ACM-V),
POLITEHNICA University Timisoara (UPT),
Academy of Romanian Scientists (AOSR)

www.acmv.ro

Papers in Plenary Session are related to the topic:

„Priorities of the European Scientific Research”

Papers in sections on the following topics:

- Section A – Technical Sciences
- Section B – Chemistry, Agriculture
- Section C – Social-Human Sciences

The aim of the Symposium is to create the framework for the presentation, debate and publication of the valuable scientific results obtained by both the young members of ACM-V and from other countries (Hungary, Serbia, Moldova, Turkey, Irak, Germany and France, on this edition)

Publication of papers:

Proceedings of the XXIst Symposium "Young People and Multidisciplinary Research", POLITEHNICA Publishing House, ISSN 1843-6609, on CD, edited by the organizers.

SCIENTIFIC JOURNALS

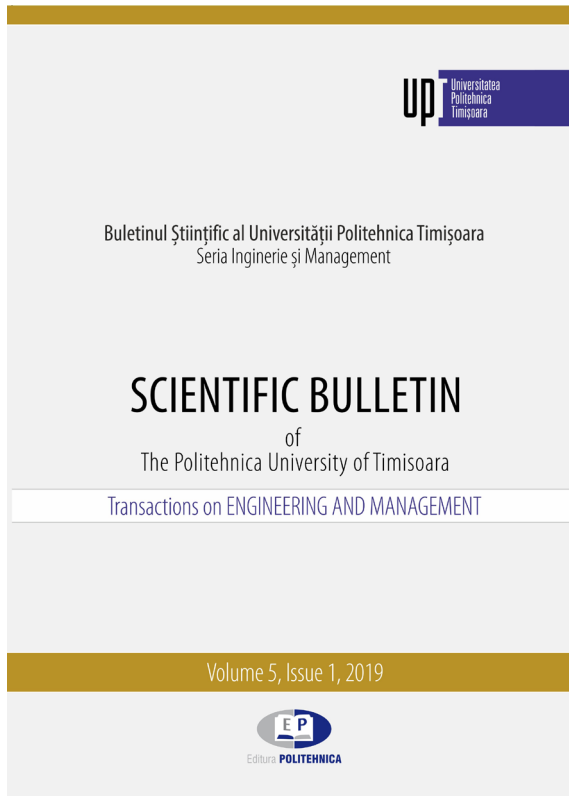

Transactions on Engineering and Management Volume 5, Issue 1, Issue 2, 2019

www.mpt.upt.ro/cercetare/buletin-stiintific.html

- The Scientific Bulletin of Politehnica University Timișoara, Transaction on Engineering and Management presents research results in the field of industrial management and business studies that are of significant impact on major contemporary issues.
- The journal welcomes submissions of theoretical, methodological, empirical, policy-oriented, as well as industrial papers in all the field. Additionally, it considers contributions that combine engineering and management studies with any other field of inquiry.
- SCIENTIFIC BULLETIN of Politehnica University Timișoara, Transactions on ENGINEERING AND MANAGEMENT is indexed: Index Copernicus, Google Scholar (under review), Ulrich (under review).



Transactions on Hydrotechnics Volume 64 (78), Issue 1, Issue 2, 2019

<http://www.ct.upt.ro/buletinhidro/index.htm>

- The Scientific Bulletin of the Politehnica University Timișoara, Transactions on Hydrotechnics is coordinated since 1992 by the Faculty of Hydrotechnical Engineering. Published papers in the journal focus on engineering sciences, civil engineering, theoretical and applied hydraulic, mathematics and numerical modeling, hydrology and water management, hydrotechnical developments and constructions, land improvement (irrigations, drainage, erosion control), engineering and sustainable rural development, water supply and sewerage systems, wastewater treatment, hydraulic structures and technologies.
- The Journal is published entirely in English, with abstracts and keywords, with international exposure.
- The revue is known for experts from home and abroad, is included in the database (Viniti, Russia) and international catalogs (SUWECO, Czech Republic). The Bulletin is broadcast in 26 foreign institutions and foreign publications received in exchange are in number of 19.



Transactions on Mathematics and Physics Volume 64 (78), Issue 1, Issue 2 , 2019

www.upt.ro/Informatii_seria-matematica_294_ro.html

- The journal "Bulletin Scientifique de l'Ecole Polytechnique de Timișoara" was founded in 1923, when the head of the Polytechnical School of Timișoara was mathematicians Victor Vâlcovici (1885-1970).
- The first two issues appeared in 1925, respectively in 1926. In the first years, the journal has been contained mostly the mathematical articles (the authors being some famous national and foreign mathematicians as well V. Alaci, G. Alexich, M. Ghermănescu, D. Pompeiu, Ch. Brunold, G. Bouligand). This fact confer to actual journal "Transactions on Mathematics and Physics" of the Scientific Bulletin of Politehnica University Timișoara, Romania the justification to realize the continuity of the old "Bulletin Scientifique".
- The **Transactions on Mathematics and Physics** is indexed CNCIS , B+.



Transactions on Modern Languages Volume 18, Issue 1, 2019

www.sc.upt.ro/ro/publicatii/buletinul-stiintific/about

- The Transactions on Modern languages, published by the Department of Communication and Foreign Languages, has its origin in The Social Science and Humanities Series, started in 1991 under ISSN 1223-1959.
- The Transactions of Modern Languages publishes original papers in all areas of theoretical and applied linguistics: Linguistics, Translation and Interpreting Studies, Discourse Analysis, Pragmatics, Rhetoric, Terminology, LSP, Foreign Language Teaching.
- The journal is included in the CEEOL, Fabula and EBSCO data bases.



Journal of Electrical Engineering Volume 19, Issue 1, Issue 2, Issue 3, Issue 4, 2019

www.jee.ro/

- JEE continues the prestigious "Scientific Bulletin" of the Politehnica University Timișoara, Electrotechnical section, but in electronic form.
- It also aims to become a fully international archival journal.
- Its scope includes all issues of widespread generic interest to engineers who work in the field of electrical engineering.
- The **Journal of Electrical Engineering** is indexed by Scopus and IEE INSPEC.



Acta Technica Corviniensis - Bulletin of Engineering Volume 12, Issue 1, Issue 2, Issue 3, Issue 4, 2019

<http://acta.fih.upt.ro/>

- ACTA TECHNICA CORVINIENSIS - Bulletin of Engineering is an independent, free-access, online, international and multidisciplinary scientific publication edited by the Politehnica University Timișoara, Faculty Engineering Hunedoara and Faculty of Mechanical Engineering Timișoara.
- The Journal is focused on engineering sciences and other innovative allied research areas, in all fields of science and technology on the basis of its originality, importance and timeliness.
- ACTA TECHNICA CORVINIENSIS - Bulletin of Engineering is accredited and ranked in the "B+" CATEGORY Journal by CNCIS, and is indexed by Index Copernicus, Google Scholar, EBSCO Publishing, DOAJ, SCIRUS, Evisa, ProQuest, DRJI, CAS, BASE, ULRICHswab - Global serials directory, Directory Indexing of International Research Journals, Electronic Journals Library etc.

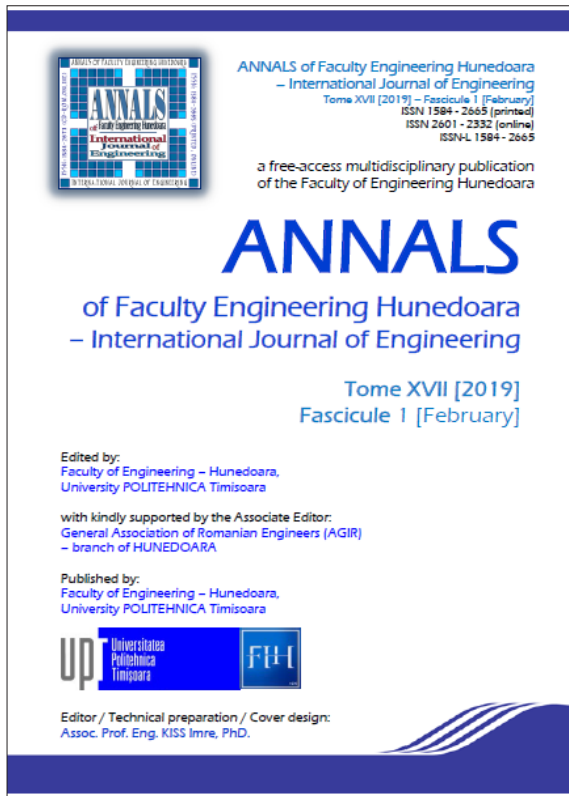

Annals of Faculty Engineering Hunedoara
International Journal of Engineering
Volume 17, Issue 1, Issue 2, Issue 3, Issue 4, 2019

<http://annals.fih.upt.ro/>

- The Journal is a multi-disciplinary journal which covers all aspects of scientific, engineering and technical disciplines including applications of scientific inventions for engineering, technological and industrial purposes, advances in engineering, technology and science.
- The Journal is accredited and ranked in the B+ category by The National University Research Council's Classification of Romanian Journals, CNCIS, and is indexed by Index Copernicus, Google Scholar, EBSCO Publishing, DOAJ, SCIRUS, EVISA, ProQuest, DRJI, CAS, BASE etc.



Academic Journal of Manufacturing Engineering
Volume 17, Issue 1, Issue 2, Issue 3, Issue 4, 2019

www.auif.utcluj.ro/en/

- The Academic Journal of Manufacturing Engineering intends to provide the specialists in the manufacturing engineering field a possibility for sharing and exchanging results and information by publishing the results of their work.
- Academic Journal of Manufacturing Engineering is recognized as a B+ journal by the Romanian National Council of Scientific Research and indexed by Index Copernicus international database.

**JOURNAL OF ARCHITECTURE
URBANISM AND HERITAGE**

University Politehnica Timisoara Romania
Faculty of Architecture and Urbanism
Vol. II - Nr. 2/2019 www.jauh.ro



Politehnica Publishing House

ISSN 2668-2249

Journal of Architecture, Urbanism and Heritage
Volume 2, Issue 1, Issue 2, 2019

www.jauh.ro/

- The JOURNAL OF ARCHITECTURE, URBANISM AND HERITAGE, JAUH, is a peer-review academic journal which publishes original research papers and advances theory, research and practice in the fields of architecture and urban planning.
- The interdisciplinary scholarly publication is aimed at advancing conceptual, scientific, and applied understandings of Architecture, Interior design, Urbanism, Built environment and Preservation and heritage studies.
- Its articles include recent research findings, empirical research papers, theoretical and integrative review articles, book reviews and innovative new practices, creating a link between theory and practice, researchers and practicing professionals.

ISI PAPERS

EVOLUTION OF ISI PAPERS UNDER AFFILIATIONS OF UPT 2015 - 2019

Scientific writing and publication marks the endpoint of research that has been performed, completed, peer reviewed and accepted, and complements teaching and training.

In this chapter we present the publications/papers written by our professors, PhD students, researchers etc. These publications can be: papers published in ISI Journals or papers presented at Conference and indexed in ISI Proceedings.

The number of papers presented in the below figures is greater than the number of papers presented in previous Research Reports. This number varies from year to year because annually it increases the number of publications indexed in the ISI Clarivate Analytics database.

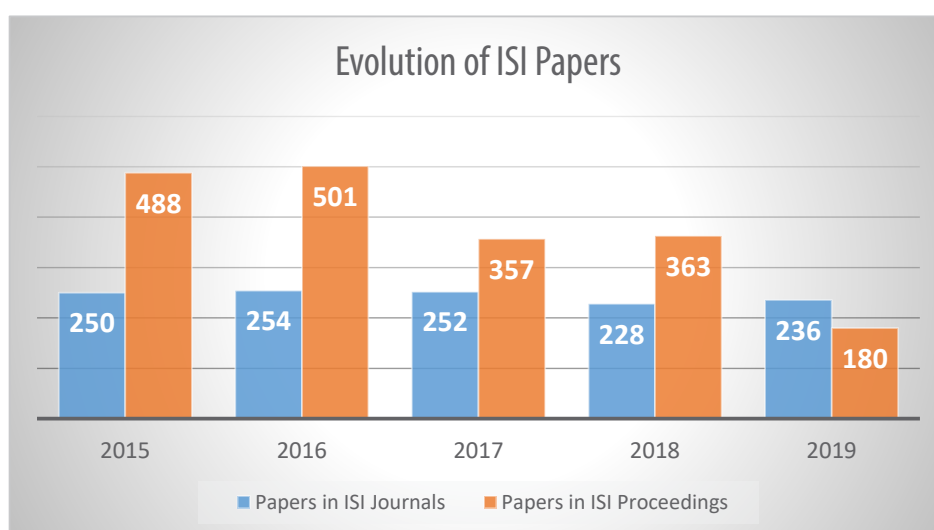
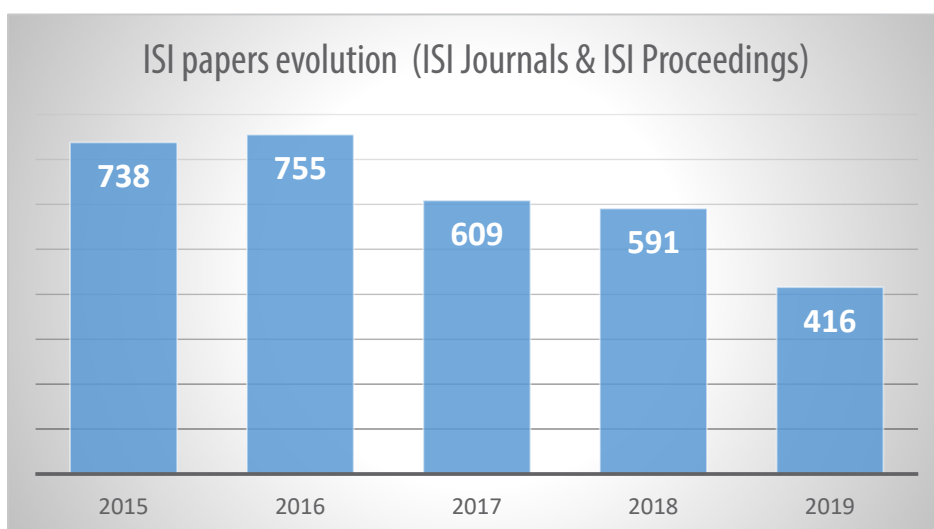

* The data was obtained from Web of Science - Clarivate Analytics in 22 June 2020

ISI Papers in highlight

Web of Science - Clarivate Analytics Highly Cited Papers

Selected from the most recent 10 years of data, Highly Cited Papers reflect the top 1% of papers by field and publication year. Highly Cited Papers help identify breakthrough research within a research field and are used within Web of Science to identify and refine the most influential research papers.

Boldea, I., Tutelea, L.N., Parsa, L., Dorrell, D. Automotive Electric Propulsion Systems With Reduced or No Permanent Magnets: An Overview, IEEE TRANSACTIONS ON INDUSTRIAL ELECTRONICS, Volume: 61, Issue: 10, Pages: 5696-5711, ISSN: 0278-0046, eISSN: 1557-9948, 2014;
Times Cited in Web of Science Core Collection: 299

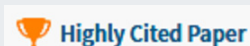

Precup, R.E., Hellendoorn, H. A survey on industrial applications of fuzzy control, COMPUTERS IN INDUSTRY, Volume: 62, Issue: 3, Pages: 213-226, ISSN: 0166-3615, eISSN: 1872-6194, 2011;
Times Cited in Web of Science Core Collection: 284

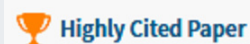

Sarbu, I., Sebarchievici, C. General review of ground-source heat pump systems for heating and cooling of buildings, ENERGY AND BUILDINGS, Volume: 70, Pages: 441-454, ISSN: 0378-7788, eISSN: 1872-6178, 2014;
Times Cited in Web of Science Core Collection: 214



Marinca, V., Herisanu, N., Bota, C., Marinca, B. An optimal homotopy asymptotic method applied to the steady flow of a fourth-grade fluid past a porous plate, APPLIED MATHEMATICS LETTERS, Volume: 22, Issue: 2, Pages: 245-251, ISSN: 0893-9659, 2009;
Times Cited in Web of Science Core Collection: 178



Gheju, M., Balcu, I. Removal of chromium from Cr(VI) polluted wastewaters by reduction with scrap iron and subsequent precipitation of resulted cations, JOURNAL OF HAZARDOUS MATERIALS, Volume: 196, Pages: 131-138, PubMed ID: 21955659, ISSN: 0304-3894, 2011;
Times Cited in Web of Science Core Collection: 152



Precup, R.E., David, R.C., Petriu, E.M. Grey Wolf Optimizer Algorithm-Based Tuning of Fuzzy Control Systems With Reduced Parametric Sensitivity, IEEE TRANSACTIONS ON INDUSTRIAL ELECTRONICS, Volume: 64, Issue: 1, Pages: 527-534, ISSN: 0278-0046, eISSN: 1557-9948, 2017;
Times Cited in Web of Science Core Collection: 91



Gheju, M., Balcu, I., Mosoarca, G. Removal of Cr(VI) from aqueous solutions by adsorption on MnO₂, JOURNAL OF HAZARDOUS MATERIALS, Volume: 310, Pages: 270-277, PubMed ID: 26947189, ISSN: 0304-3894, eISSN: 1873-3336, 2016;
Times Cited in Web of Science Core Collection: 82

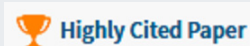

Highly Cited Papers received enough citations as of January/December 2019 to place them in the top 1% of their academic fields based on a highly cited threshold for the field and publication year.

* The data was obtained from Web of Science - Clarivate Analytics in 25 May 2020

Web of Science - Clarivate Analytics Highly Cited Paper

Selected from the most recent 10 years of data, Highly Cited Papers reflect the top 1% of papers by field and publication year. Highly Cited Papers help identify breakthrough research within a research field and are used within Web of Science to identify and refine the most influential research papers.

Sarbu, I., Sebarchievici, C. A Comprehensive Review of Thermal Energy Storage, SUSTAINABILITY, Volume: 10, Issue: 1, Article Number: 191, ISSN: 2071-1050, 2018;
Times Cited in Web of Science Core Collection: 80

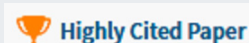

Ancuti, C.O., Ancuti, C., De Vleeschouwer, C., Bekaert, P. Color Balance and Fusion for Underwater Image Enhancement, IEEE TRANSACTIONS ON IMAGE PROCESSING, Volume: 27, Issue: 1, Pages: 379-393, PubMed ID: 28981416, ISSN: 1057-7149, eISSN: 1941-0042, 2018;
Times Cited in Web of Science Core Collection: 60



Sarbu, I., Dorca, A. Review on heat transfer analysis in thermal energy storage using latent heat storage systems and phase change materials, INTERNATIONAL JOURNAL OF ENERGY RESEARCH, Volume: 43, Issue: 1, Pages: 29-64, ISSN: 0363-907X, eISSN: 1099-114X, 2019;
Times Cited in Web of Science Core Collection: 22



Linul, E., Marsavina, L., Linul, P.A., Kovacic, J. Cryogenic and high temperature compressive properties of Metal Foam Matrix Composites, COMPOSITE STRUCTURES, Volume: 209, Pages: 490-498, ISSN: 0263-8223, eISSN: 1879-1085, 2019;
Times Cited in Web of Science Core Collection: 20



Istratie, R., Stoia, M., Pacurariu, C., Locovei, C. Single and simultaneous adsorption of methyl orange and phenol onto magnetic iron oxide/carbon nanocomposites, ARABIAN JOURNAL OF CHEMISTRY, Volume: 12, Issue: 8, Pages: 3704-3722, ISSN: 1878-5352, eISSN: 1878-5379, 2019;
Times Cited in Web of Science Core Collection: 20



Gheju, M., Balcu, I. Sustaining the efficiency of the Fe(0)/H₂O system for Cr(VI) removal by MnO₂ amendment, CHEMOSPHERE, Volume: 214, Pages: 389-398, PubMed ID: 30268895, ISSN: 0045-6535, eISSN: 1879-1298, 2019;
Times Cited in Web of Science Core Collection: 12

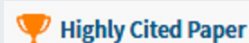

Duma, V.F., Schitea, A. LASER SCANNERS WITH ROTATIONAL RISLEY PRISMS: EXACT SCAN PATTERNS, PROCEEDINGS OF THE ROMANIAN ACADEMY SERIES A-MATHEMATICS PHYSICS TECHNICAL SCIENCES INFORMATION SCIENCE, Volume: 19, Issue: 1, Pages: 53-60, ISSN: 1454-9069, 2018;
Times Cited in Web of Science Core Collection: 10

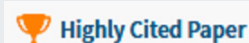

Highly Cited Papers received enough citations as of January/December 2019 to place them in the top 1% of their academic fields based on a highly cited threshold for the field and publication year.

*The data was obtained from Web of Science - Clarivate Analytics in 25 May 2020

Web of Science - Clarivate Analytics Highly Cited Paper

As of January/December 2019, this highly cited paper received enough citations to place it in the top 1% of the academic field of **Engineering** based on a highly cited threshold for the field and publication year.

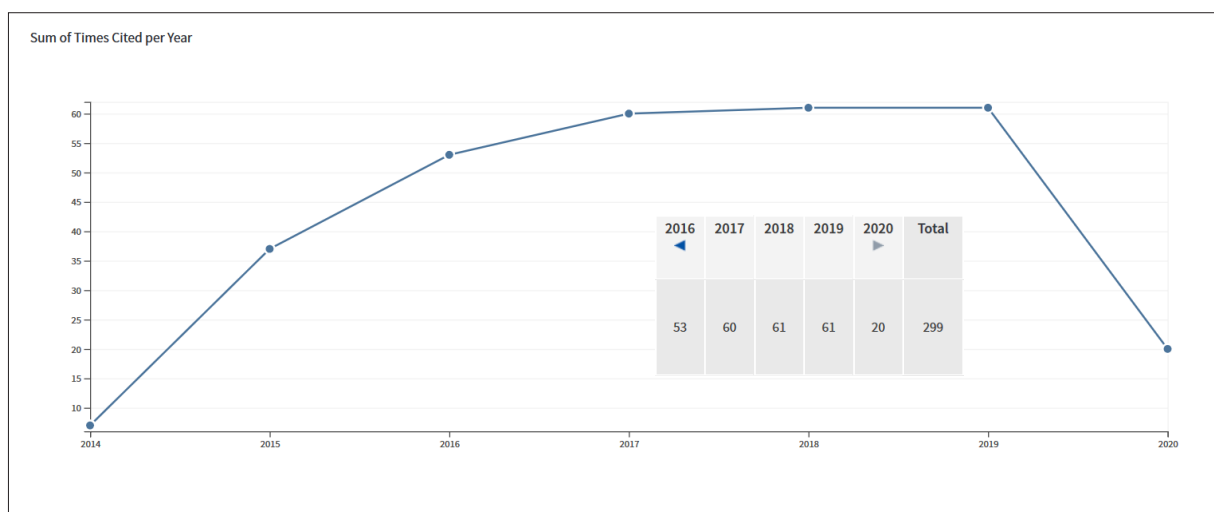

Boldea, I., Tutelea, L.N., Parsa, L., Dorrell, D. Automotive Electric Propulsion Systems With Reduced or No Permanent Magnets: An Overview, IEEE TRANSACTIONS ON INDUSTRIAL ELECTRONICS, Volume: 61, Issue: 10, Pages: 5696-5711, ISSN: 0278-0046, eISSN: 1557-9948, 2014;
Times Cited in Web of Science Core Collection: 299

Abstract: Hybrid and electric vehicle technology has seen rapid development in recent years. The motor and the generator are at the heart of the vehicle drive and energy system and often utilize expensive rare-earth permanent magnet (PM) material. This paper reviews and addresses the research work that has been carried out to reduce the amount of rare-earth material that is used while maintaining the high efficiency and performance that rare-earth PM machines offer. These new machines can use either less rare-earth PM material,

weaker ferrite magnets, or no magnets; and they need to meet the high performance that the more usual interior PM synchronous motor with sintered neodymium-iron-boron magnets provides. These machines can take the form of PM-assisted synchronous reluctance machines, induction machines, switched reluctance machines, wound rotor synchronous machines (claw pole or biaxially excited), double-saliency machines with ac or dc stator current control, or brushless dc multiple-phase reluctance machines.

Web of Science - Clarivate Analytics Highly Cited Paper

As of January/December 2019, this highly cited paper received enough citations to place it in the top 1% of the academic field of **Computer Science** based on a highly cited threshold for the field and publication year.

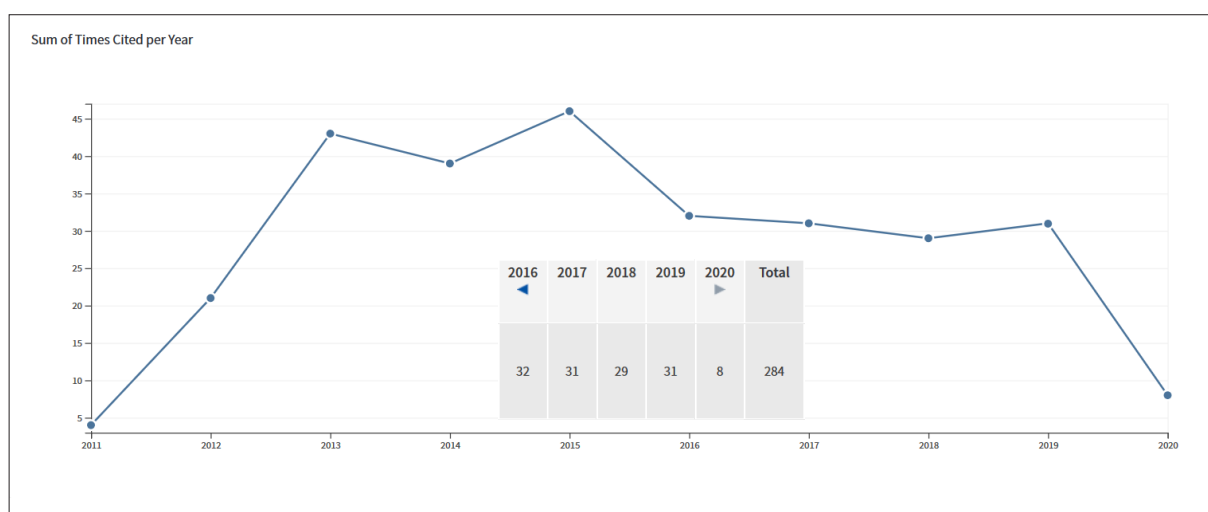

Precup, R.E., Hellendoorn, H. A survey on industrial applications of fuzzy control, *COMPUTERS IN INDUSTRY*, Volume: 62, Issue: 3, Pages: 213-226, ISSN: 0166-3615, eISSN: 1872-6194, 2011;
Times Cited in Web of Science Core Collection: 284

Abstract: Fuzzy control has long been applied to industry with several important theoretical results and successful results. Originally introduced as model-free control design approach, model-based fuzzy control has gained widespread significance in the past decade.

This paper presents a survey on recent developments of analysis and design of fuzzy control systems focused on industrial applications reported after 2000.

Web of Science - Clarivate Analytics Highly Cited Paper

As of January/December 2019, this highly cited paper received enough citations to place it in the top 1% of the academic field of **Engineering** based on a highly cited threshold for the field and publication year.

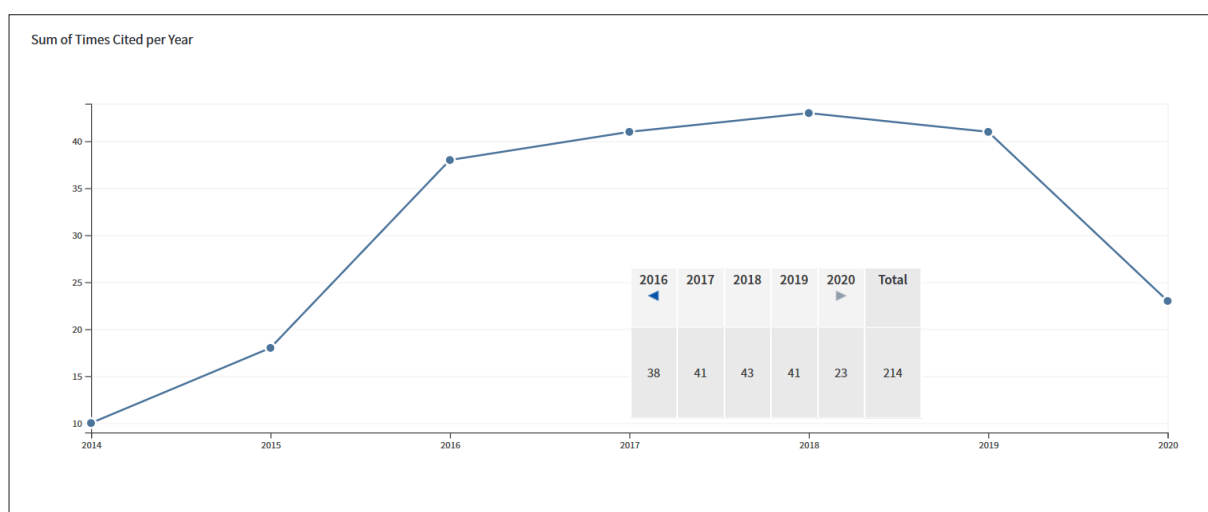

Sarbu, I., Sebarchievici, C. General review of ground-source heat pump systems for heating and cooling of buildings, *ENERGY AND BUILDINGS*, Volume: 70, Pages: 441-454, ISSN: 0378-7788, eISSN: 1872-6178, 2014;
Times Cited in Web of Science Core Collection: 214

Abstract: A large number of ground-source heat pumps (GSHP) systems have been used in residential and commercial buildings throughout the world due to the attractive advantages of high energy and environmental performances. The GSHPs are proven renewable energy technology for space heating and cooling. This paper provides a detailed literature review of the GSHP systems, and their recent advances. The operation principle and energy efficiency of a heat pump are defined first. Then, a general introduction on the GSHPs and its development, and a detailed description of the surface water (SWHP), ground-water (GWHP), and ground-couplet (GCHP) heat pumps are performed. The most typical simulation and ground thermal response

test models for the vertical ground heat exchangers currently available are summarized including the heat transfer processes outside and inside the boreholes. Also, some information about a new GWHP using a heat exchanger with special construction, and the possibility to obtain the better energy efficiency with combined heating and cooling by GCHP are presented. The various hybrid GCHP systems for cooling or heating-dominated buildings are well described. Finally, the energy, economic and environmental performance of a closed-loop GCHP system is also briefly reviewed. It is found that the GSHP technology can be used both in cold and hot weather areas and the energy saving potential is significant.

Web of Science - Clarivate Analytics Highly Cited Paper

As of January/December 2019, this highly cited paper received enough citations to place it in the top 1% of the academic field of **Mathematics** based on a highly cited threshold for the field and publication year.

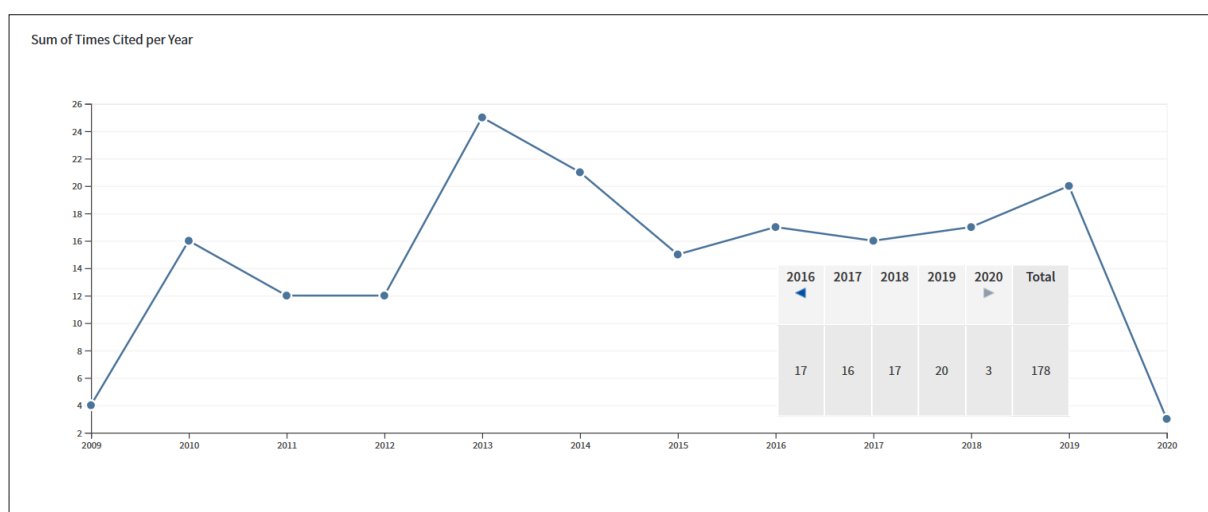

Marinca, V., Herisanu, N., Bota, C., Marinca, B. An optimal homotopy asymptotic method applied to the steady flow of a fourth-grade fluid past a porous plate, *APPLIED MATHEMATICS LETTERS*, Volume: 22, Issue: 2, Pages: 245-251, ISSN: 0893-9659, 2009;
Times Cited in Web of Science Core Collection: 178

Abstract: A new analytic approximate technique for addressing nonlinear problems, namely the Optimal Homotopy Asymptotic Method (OHAM), is proposed and used in an application to the steady flow of a fourth-grade fluid. This approach does not depend upon any small/large parameters. This method provides us with a convenient

way to control the convergence of approximation series and adjust convergence regions when necessary. The series solution is developed and the recurrence relations are given explicitly. The results reveal that the proposed method is effective and easy to use.

Web of Science - Clarivate Analytics Highly Cited Paper

As of January/December 2019, this highly cited paper received enough citations to place it in the top 1% of the academic field of **Engineering** based on a highly cited threshold for the field and publication year.

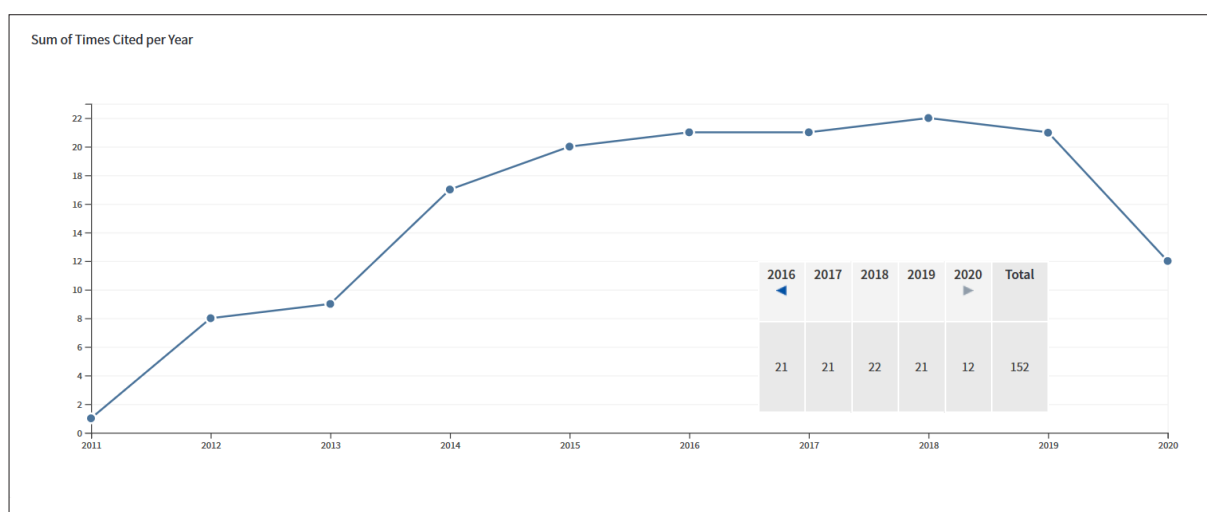

Gheju, M., Balcu, I. Removal of chromium from Cr(VI) polluted wastewaters by reduction with scrap iron and subsequent precipitation of resulted cations, JOURNAL OF HAZARDOUS MATERIALS, Volume: 196, Pages: 131-138, PubMed ID: 21955659, ISSN: 0304-3894, 2011;
Times Cited in Web of Science Core Collection: 152

Abstract: This work presents investigations on the total removal of chromium from Cr(VI) aqueous solutions by reduction with scrap iron and subsequent precipitation of the resulted cations with NaOH. The process was detrimentally affected by a compactly passivation film occurred at scrap iron surface, mainly composed of Cr(III) and Fe(III). Maximum removal efficiency of the Cr(total) and Fe(total) achieved in the clarifier under circumneutral and alkaline (pH 9.1) conditions was 98.5% and 100%, respectively. The optimum precipitation pH range which resulted from this study is 7.6-8.0. Fe(total) and Cr(total) were

almost entirely removed in the clarifier as Fe(III) and Cr(III) species: however, after Cr(VI) breakthrough in column effluent, chromium was partially removed in the clarifier also as Cr(VI), by coprecipitation with cationic species. As long the column effluent was free of Cr(VI), the average Cr(total) removal efficiency of the packed column and clarifier was 10.8% and 78.8%, respectively. Our results clearly indicated that Cr(VI) contaminated wastewater can be successfully treated by combining reduction with scrap iron and chemical precipitation with NaOH.

Web of Science - Clarivate Analytics Highly Cited Paper

As of January/December 2019, this highly cited paper received enough citations to place it in the top 1% of the academic field of **Engineering** based on a highly cited threshold for the field and publication year.

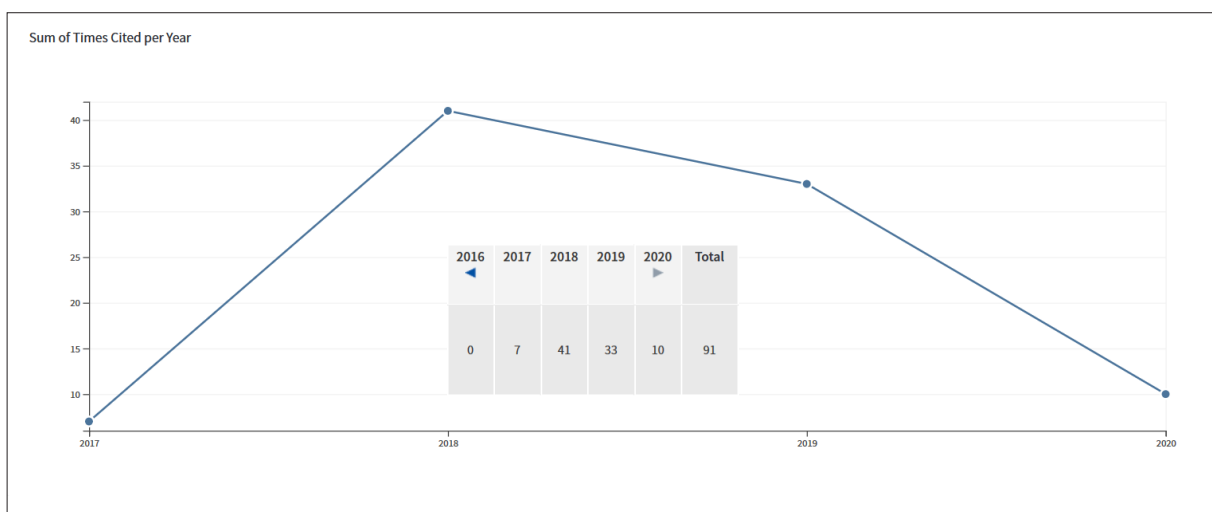

Precup, R.E., David, R.C., Petriu, E.M. Grey Wolf Optimizer Algorithm-Based Tuning of Fuzzy Control Systems With Reduced Parametric Sensitivity, IEEE TRANSACTIONS ON INDUSTRIAL ELECTRONICS, Volume: 64, Issue: 1, Pages: 527-534, ISSN: 0278-0046, eISSN: 1557-9948, 2017; Times Cited in Web of Science Core Collection: 91

Abstract: This paper proposes an innovative tuning approach for fuzzy control systems (CSs) with a reduced parametric sensitivity using the Grey Wolf Optimizer (GWO) algorithm. The CSs consist of servo system processes controlled by Takagi-Sugeno-Kang proportional-integral fuzzy controllers (TSK PI-FCs). The process models have second-order dynamics with an integral component, variable parameters, a saturation, and dead-zone static nonlinearity. The sensitivity analysis employs output sensitivity functions of the sensitivity models defined

with respect to the parametric variations of the processes. The GWO algorithm is used in solving the optimization problems, where the objective functions include the output sensitivity functions. GWO's motivation is based on its low-computational cost. The tuning approach is validated in an experimental case study of a position control for a laboratory nonlinear servo system, and TSK PI-FCs with a reduced process small time constant sensitivity are offered.

Web of Science - Clarivate Analytics Highly Cited Paper

As of January/December 2019, this highly cited paper received enough citations to place it in the top 1% of the academic field of **Engineering** based on a highly cited threshold for the field and publication year.

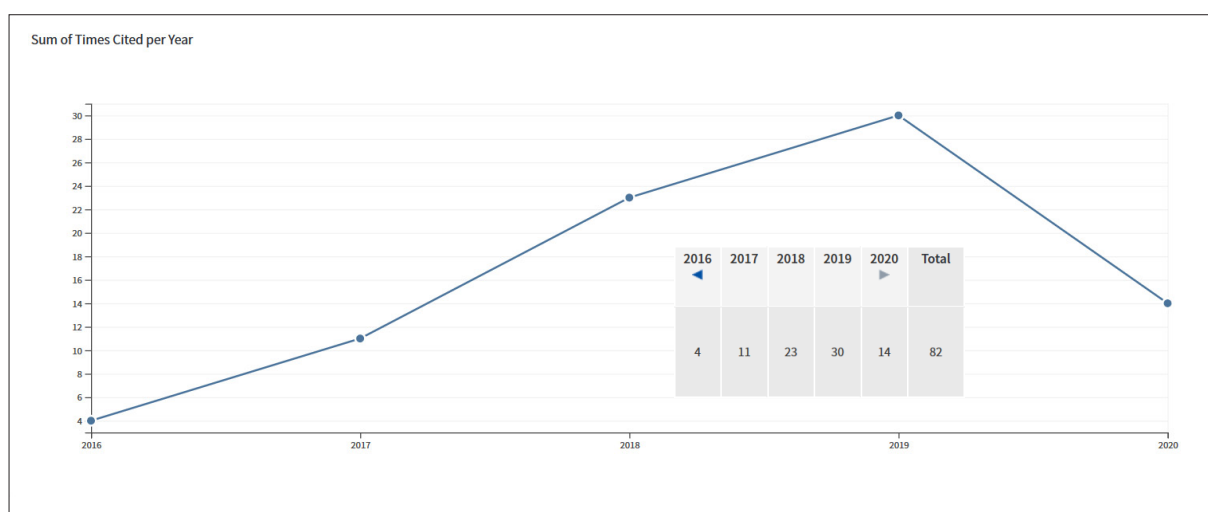

Gheju, M., Balcu, I., Mosoarca, G. Removal of Cr(VI) from aqueous solutions by adsorption on MnO₂, JOURNAL OF HAZARDOUS MATERIALS, Volume: 310, Pages: 270-277, PubMed ID: 26947189, ISSN: 0304-3894, eISSN: 1873-3336, 2016;
Times Cited in Web of Science Core Collection: 82

Abstract: Adsorption of Cr(VI) on MnO₂ was investigated with respect to effect of pH, temperature, ionic strength, initial Cr(VI) concentration, co-presence of different anions (HCO₃⁻, SO₄²⁻, H₂PO₄⁻, NO₃⁻ and Cl⁻) and of low molecular weight natural organic materials (LMWNOM) (acetate, oxalate and citrate). The process was rapid during the first 3-5 min, reaching equilibrium after one hour. Adsorption decreased with increasing pH, temperature and Cr(VI) initial concentration, and increased with increasing ionic strength. Co-presence of phosphate, sulfate, bicarbonate, citrate and oxalate hindered Cr(VI) adsorption, whereas nitrate, chloride and acetate did not exert any notable influence. The overall order of Cr(VI) adsorption suppression due to

co-presence of anions and LMWNOM was H₂PO₄⁻ > HCO₃⁻ > SO₄²⁻, and oxalate > citrate, respectively. Highest experimental equilibrium sorption capacity (0.83 mg g⁻¹) was obtained at 20 degrees C and pH 5.9, while lowest (0.18 mg g⁻¹) was noticed in the co-presence of H₂PO₄⁻, at 20 degrees C and pH 6.9. Adsorption kinetics was successfully fitted by pseudo-second-order model. Mechanisms for both specific and non-specific adsorption are likely to be involved, while rate-controlling step involved both intra-particle and film diffusion processes. Cr(VI) was strongly bound to MnO₂, which makes risks of its subsequent liberation into the environment to be low.

Web of Science - Clarivate Analytics Highly Cited Paper

As of January/December 2019, this highly cited paper received enough citations to place it in the top 1% of the academic field of **Environment/Ecology** based on a highly cited threshold for the field and publication year.

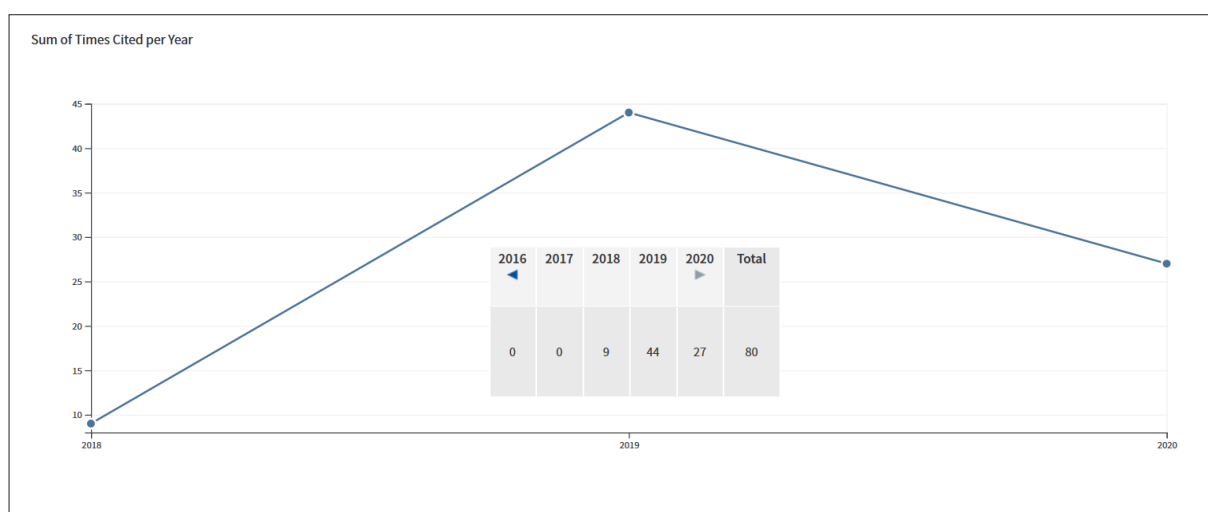

Sarbu, I., Sebarchievici, C. A Comprehensive Review of Thermal Energy Storage, SUSTAINABILITY, Volume: 10, Issue: 1, Article Number: 191, ISSN: 2071-1050, 2018;
Times Cited in Web of Science Core Collection: 80

Abstract: Thermal energy storage (TES) is a technology that stocks thermal energy by heating or cooling a storage medium so that the stored energy can be used at a later time for heating and cooling applications and power generation. TES systems are used particularly in buildings and in industrial processes. This paper is focused on TES technologies that provide a way of valorizing solar heat and reducing the energy demand of buildings. The principles of several energy storage methods and calculation of storage capacities are

described. Sensible heat storage technologies, including water tank, underground, and packed-bed storage methods, are briefly reviewed. Additionally, latent-heat storage systems associated with phase-change materials for use in solar heating/cooling of buildings, solar water heating, heat-pump systems, and concentrating solar power plants as well as thermo-chemical storage are discussed. Finally, cool thermal energy storage is also briefly reviewed and outstanding information on the performance and costs of TES systems are included.

Web of Science - Clarivate Analytics Highly Cited Paper

As of September/December 2019, this highly cited paper received enough citations to place it in the top 1% of the academic field of **Engineering** based on a highly cited threshold for the field and publication year.

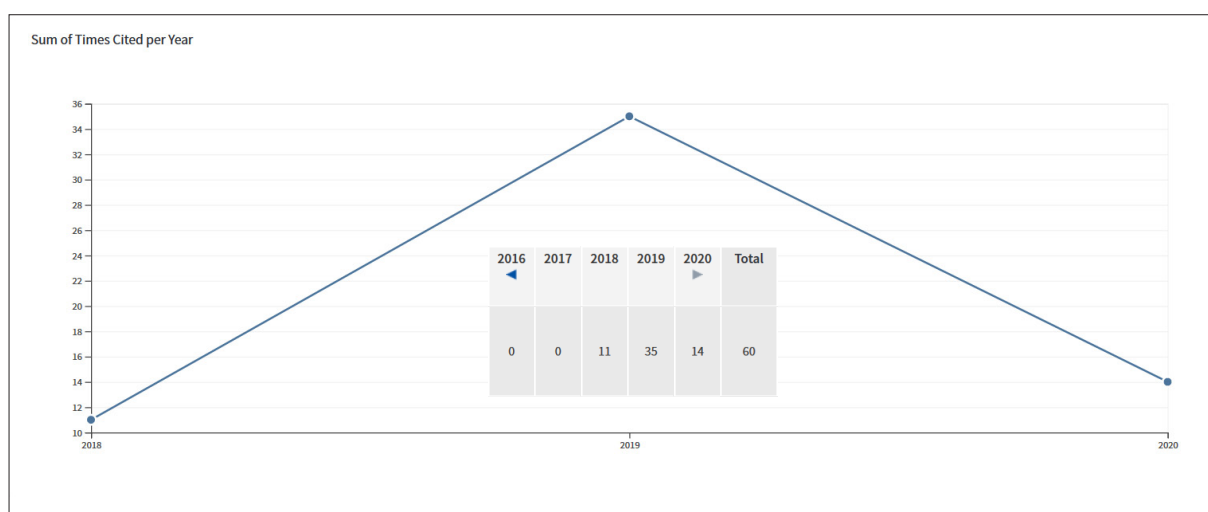

Ancuti, C.O., Ancuti, C., De Vleeschouwer, C., Bekaert, P. Color Balance and Fusion for Underwater Image Enhancement, IEEE TRANSACTIONS ON IMAGE PROCESSING, Volume: 27, Issue: 1, Pages: 379-393, PubMed ID: 28981416, ISSN: 1057-7149, eISSN: 1941-0042, 2018;
Times Cited in Web of Science Core Collection: 60

Abstract: We introduce an effective technique to enhance the images captured underwater and degraded due to the medium scattering and absorption. Our method is a single image approach that does not require specialized hardware or knowledge about the underwater conditions or scene structure. It builds on the blending of two images that are directly derived from a color-compensated and white-balanced version of the original degraded image. The two images to fusion, as well as their associated weight maps, are defined to promote the transfer of edges and color contrast to the output

image. To avoid that the sharp weight map transitions create artifacts in the low frequency components of the reconstructed image, we also adapt a multiscale fusion strategy. Our extensive qualitative and quantitative evaluation reveals that our enhanced images and videos are characterized by better exposedness of the dark regions, improved global contrast, and edges sharpness. Our validation also proves that our algorithm is reasonably independent of the camera settings, and improves the accuracy of several image processing applications, such as image segmentation and keypoint matching.

Web of Science - Clarivate Analytics Highly Cited Paper

As of July/December 2019, this highly cited paper received enough citations to place it in the top 1% of the academic field of **Engineering** based on a highly cited threshold for the field and publication year.

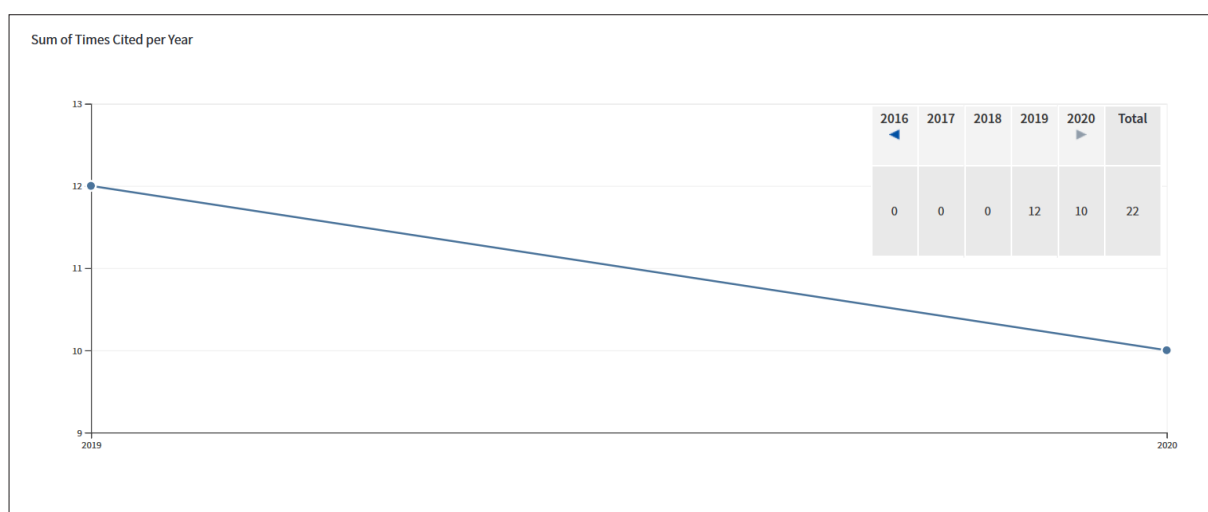

Sarbu, I., Dorca, A. Review on heat transfer analysis in thermal energy storage using latent heat storage systems and phase change materials, *INTERNATIONAL JOURNAL OF ENERGY RESEARCH*, Volume: 43, Issue: 1, Pages: 29-64, ISSN: 0363-907X, eISSN: 1099-114X, 2019; Times Cited in Web of Science Core Collection: 22

Abstract: Thermal energy storage (TES) is a technology that stocks thermal energy by heating or cooling a storage medium so that the stored energy can be used later for heating and cooling applications and for power generation. TES has recently attracted increasing interest to thermal applications such as space and water heating, waste heat utilisation, cooling, and air conditioning. Phase change materials (PCMs) used for the storage of thermal energy as latent heat are special types of advanced materials that substantially contribute to the efficient use and conservation of waste heat and solar energy. This paper provides a comprehensive review on the development of latent heat storage (LHS) systems focused on heat transfer and enhancement techniques employed in PCMs to effectively charge and discharge

latent heat energy, and the formulation of the phase change problem. The main categories of PCMs are classified and briefly described, and heat transfer enhancement technologies, namely dispersion of low-density materials, use of porous materials, metal matrices and encapsulation, incorporation of extended surfaces and fins, utilisation of heat pipes, cascaded storage, and direct heat transfer techniques, are also discussed in detail. Additionally, a two-dimensional heat transfer simulation model of an LHS system is developed using the control volume technique to solve the phase change problem. Furthermore, a three-dimensional numerical simulation model of an LHS is built to investigate the quasi-steady state and transient heat transfer in PCMs. Finally, several future research directions are provided.

Web of Science - Clarivate Analytics Highly Cited Paper

As of March/October 2019, this highly cited paper received enough citations to place it in the top 1% of the academic field of **Materials Science** based on a highly cited threshold for the field and publication year.

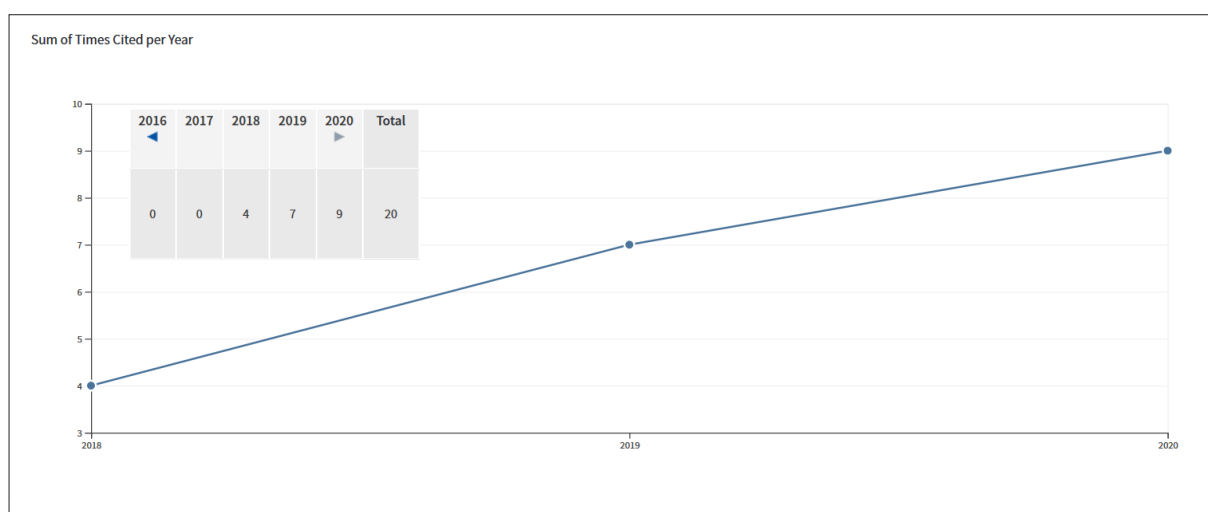

Linul, E., Marsavina, L., Linul, P.A., Kovacic, J. Cryogenic and high temperature compressive properties of Metal Foam Matrix Composites, COMPOSITE STRUCTURES, Volume: 209, Pages: 490-498, ISSN: 0263-8223, eISSN: 1879-1085, 2019;
Times Cited in Web of Science Core Collection: 20

Abstract: The cryogenic (- 196 degrees C), room (25 degrees C) and high (250 degrees C) temperature compressive crushing performances of recently developed metal foam matrix composites was investigated with respect to the position of reinforcements on foam samples. Closed-cell aluminum alloy foams were produced via powder metallurgical route from A1Si10 matrix material; while diamond shape expanded stainless steel were used as reinforcements. The deformation behavior and main mechanical properties of the unreinforced and reinforced metallic foam was found to be strongly

temperature dependent under quasi-static loading. Reinforced foams exhibited much higher strength properties and energy absorption capability compared to unreinforced foams at almost the same overall weight of the samples, i.e. up to 11 times. The properties percentage reductions of the reinforced foams are significantly below the reduction of the unreinforced foam. Furthermore, it was observed that the collapse mechanisms and mechanical properties of the reinforced foams depends on reinforcement position.

Web of Science - Clarivate Analytics Highly Cited Paper

As of November/December 2019, this highly cited paper received enough citations to place it in the top 1% of the academic field of **Chemistry** based on a highly cited threshold for the field and publication year.

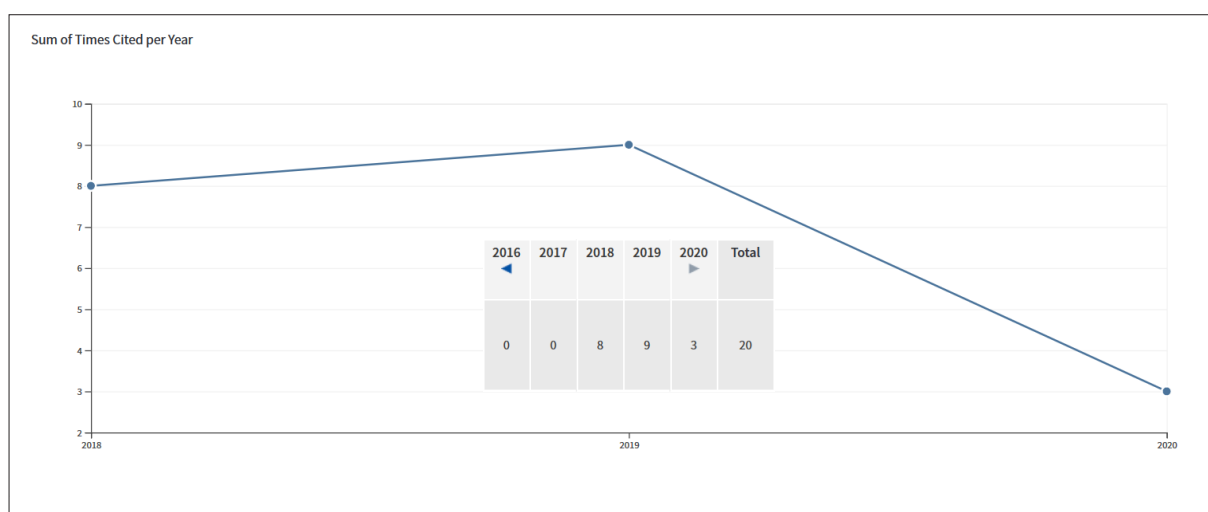

Istratie, R., Stoia, M., Pacurariu, C., Locovei, C. Single and simultaneous adsorption of methyl orange and phenol onto magnetic iron oxide/carbon nanocomposites, ARABIAN JOURNAL OF CHEMISTRY, Volume: 12, Issue: 8, Pages: 3704–3722, ISSN: 1878-5352, eISSN: 1878-5379, 2019; Times Cited in Web of Science Core Collection: 20

Abstract: Magnetic iron oxide/carbon nanocomposites were synthesized by a facile, one-step solvothermal method. The magnetic nanopowders were characterized by X-ray diffraction (XRD), Fourier transform infrared (FTIR) spectroscopy, thermal analysis (DSC-TG), scanning electron microscopy (SEM), specific surface area and particle size measurements, pore size distributions and magnetic properties. The magnetic nanopowders were tested as adsorbents for the removal of methyl orange (MO) and phenol (Ph) from aqueous solutions. The effects of solution pH, contact time, adsorbent dose and initial pollutants concentration on the adsorption of MO and phenol onto the investigated adsorbents were studied. A significant increase in the removal efficiency, both for MO and phenol, with the increase in the carbon content of the magnetic nanopowder was evidenced.

New experimental data were provided regarding the bicomponent adsorption of MO and phenol. Pseudo-second order equation was fitted to the kinetic data and four isotherm models, namely Langmuir, Freundlich, Redlich-Peterson and Sips were used to analyze the equilibrium data in both single and binary-component solutions. The investigated adsorbents showed a higher adsorption capacity toward MO than phenol. The simultaneous adsorption of the two pollutants in bicomponent solutions indicated that the MO adsorption is practically not affected by the presence of phenol while the adsorption of phenol is significantly reduced in the presence of MO. The benefits of obtaining low-cost nanocomposites with adsorption capacity and magnetic separation tailored, effective in single and bicomponent adsorption of MO and phenol, represent strong arguments regarding their great potential for practical applications.

Web of Science - Clarivate Analytics Highly Cited Paper

As of January/June and November/December 2019, this highly cited paper received enough citations to place it in the top 1% of the academic field of **Environment/Ecology** based on a highly cited threshold for the field and publication year.

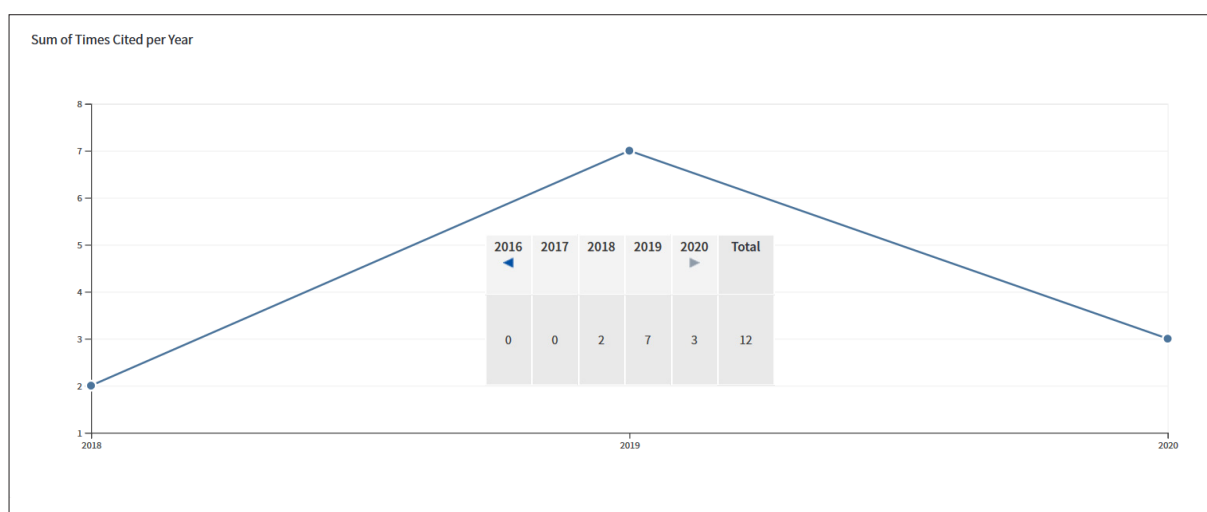

Gheju, M., Balcu, I. Sustaining the efficiency of the Fe(0)/H₂O system for Cr(VI) removal by MnO₂ amendment, CHEMOSPHERE, Volume: 214, Pages: 389-398, PubMed ID: 30268895, ISSN: 0045-6535, eISSN: 1879-1298, 2019;
Times Cited in Web of Science Core Collection: 12

Abstract: This study aims to provide new knowledge regarding the effect of MnO₂ co-presence on efficiency of Cr(VI) removal with Fe(0). Non-disturbed batch experiments (≤ 40 days) were conducted using two types of Fe(0) (milli- and micro-sized), two Cr(VI) concentrations (5 and 100 mg/L), in three different systems ("Fe(0) only", "MnO₂ only", and "Fe(0) + MnO₂"), at an initial pH value of 6.9. Compared to "Fe(0) only" system, the efficiency and rate of Cr(VI) removal were highly promoted in "Fe(0) + MnO₂" system; moreover, while for the "Fe(0) only" system removal of Cr(VI) was severely hindered by increasing Cr(VI) concentration, in "Fe(0) + MnO₂" system comparable high efficacies were noticed both at low and

high concentration. Recycling experiments indicated that total Cr(VI) removal capacity of "Fe(0) + MnO₂" system was up to 48.1 times greater than of the "Fe(0) only" system. Enhanced removal of Cr(VI) with Fe(0) was achieved at low doses of MnO₂, with an optimal mass ratio Fe(0):MnO₂ of 4:1. The favorable synergistic effect observed in "Fe(0) + MnO₂" system was ascribed to capacity of MnO₂ to accelerate Fe(0) oxidative dissolution, and to generate supplementary amounts of secondary adsorbents/reductants with removal ability towards Cr(VI). This study provides compelling evidence that "Fe(0) + MnO₂" system could represent a highly efficient and cost-effective alternative for the abatement of Cr(VI) aqueous pollution.

Web of Science - Clarivate Analytics Highly Cited Paper

As of January/February 2019, this highly cited paper received enough citations to place it in the top 1% of the academic field of **Mathematics** based on a highly cited threshold for the field and publication year.

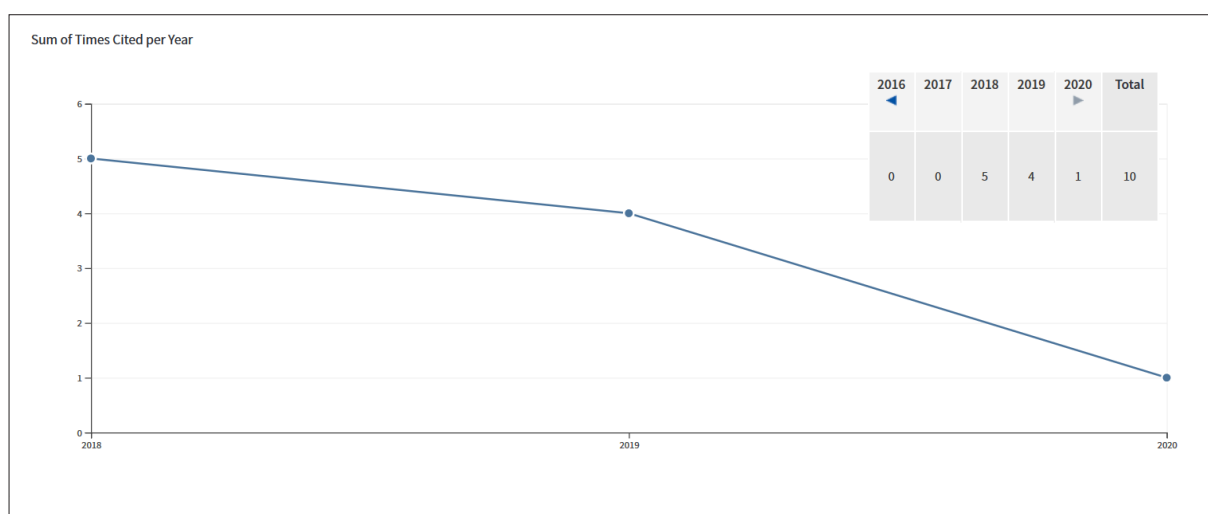

Duma, V.F., Schitea, A. LASER SCANNERS WITH ROTATIONAL RISLEY PRISMS: EXACT SCAN PATTERNS, PROCEEDINGS OF THE ROMANIAN ACADEMY SERIES A-MATHEMATICS PHYSICS TECHNICAL SCIENCES INFORMATION SCIENCE, Volume: 19, Issue: 1, Pages: 53-60, ISSN: 1454-9069, 2018;
Times Cited in Web of Science Core Collection: 10

Abstract: We approach the exact scan patterns produced by scanners with rotational Risley prisms. Previous methods have considered such studies mostly approximately, in the paraxial domain or using the third-order theory. Exact, but complicated analytical solutions have also been developed. In contrast, we propose a novel, easy-to-use, graphical method, in order to complete the exact modeling of the scanning process: with a mechanical design program, CATIA V5R20 (Dassault Systemes, Paris, France). By ray-tracing using the prisms

equations, the scan patterns are determined and studied with regard to the characteristic parameters of the device: prism angles and their rotational speeds, as well as the scanner geometry. Marshall's characteristic parameters are utilized: the ratios of the prism angles and of the rotational speeds. An experimental validation of the modeling procedure is completed. The exact modeling method proposed allows for choosing the most appropriate parameters of the device in order to obtain a certain scan pattern for a specific application.

No.	Article	2018 Impact Factor / Quartile in Category
1.	Albulescu, C.T., Tiwari, A.K., Yoon, S.M., Kang, S.H. FDI, income, and environmental pollution in Latin America: Replication and extension using panel quantiles regression analysis, ENERGY ECONOMICS, Volume: 84, Article Number: UNSP 104504, ISSN: 0140-9883, eISSN: 1873-6181, 2019;	4.151 / Q1
2.	Albulescu, C.T., Demirel, R., Raheem, I.D., Tiwari, A.K. Does the US economic policy uncertainty connect financial markets? Evidence from oil and commodity currencies, ENERGY ECONOMICS, Volume: 83, Pages: 375-388, ISSN: 0140-9883, eISSN: 1873-6181, 2019;	4.151 / Q1
3.	Aliha, M.R.M., Mousavi, S.S., Bahmani, A., Linul, E., Marsavina, L. Crack initiation angles and propagation paths in polyurethane foams under mixed modes I/II and I/III loading, THEORETICAL AND APPLIED FRACTURE MECHANICS, Volume: 101, Pages: 152-161, ISSN: 0167-8442, eISSN: 1872-7638, 2019;	2.848 / Q1
4.	Ancuti, C.O., Ancuti, C., De Vleeschouwer, C., Sbet, M. Color Channel Transfer for Image Dehazing, IEEE SIGNAL PROCESSING LETTERS, Volume: 26, Issue: 10, Pages: 1413-1417, ISSN: 1070-9908, eISSN: 1558-2361, 2019;	3.268 / Q2
5.	Antoniac, I.V., Stoia, D.I., Ghiban, B., Tecu, C., Miculescu, F., Vigar, C., Saceleanu, V. Failure Analysis of a Humeral Shaft Locking Compression Plate Surface Investigation and Simulation by Finite Element Method, MATERIALS, Volume: 12, Issue: 7, Article Number: 1128, PubMed ID: 30959903, ISSN: 1996-1944, 2019;	2.972 / Q2
6.	Aparaschivei, D., Todea, A., Frissen, A.E., Badea, V., Rusu, G., Sisu, E., Puiu, M., Boeriu, C.G., Peter, F. Enzymatic synthesis and characterization of novel terpolymers from renewable sources, PURE AND APPLIED CHEMISTRY, Volume: 91, Issue: 3, Pages: 397-408, ISSN: 0033-4545, eISSN: 1365-3075, 2019;	2.35 / Q2
7.	Avram, S., Udrea, A.M., Negrea, A., Ciopec, M., Duteanu, N., Postolache, C., Duda-Seiman, C., Duda-Seiman, D., Shaposhnikov, S. Prevention of Deficit in Neuropsychiatric Disorders through Monitoring of Arsenic and Its Derivatives as Well as Through Bioinformatics and Cheminformatics, INTERNATIONAL JOURNAL OF MOLECULAR SCIENCES, Volume: 20, Issue: 8, Article Number: 1804, PubMed ID: 31013686, eISSN: 1422-0067, 2019;	4.183 / Q2
8.	Baba, M., Gui, V., Cernazanu, C., Pescaru, D. A Sensor Network Approach for Violence Detection in Smart Cities Using Deep Learning, SENSORS, Volume: 19, Issue: 7, Article Number: 1676, PubMed ID: 30965646, eISSN: 1424-8220, 2019;	3.031 / Q1
9.	Banias, O. Test case selection-prioritization approach based on memoization dynamic programming algorithm, INFORMATION AND SOFTWARE TECHNOLOGY, Volume: 115, Pages: 119-130, ISSN: 0950-5849, eISSN: 1873-6025, 2019;	2.921 / Q1
10.	Belega, D., Petri, D. Influence of the noise on DFT-based sine-wave frequency and amplitude estimators, MEASUREMENT, Volume: 137, Pages: 527-534, ISSN: 0263-2241, eISSN: 1873-412X, 2019;	2.791 / Q2
11.	Bereczky, F., Silea, I. New Nature-Inspired Cycloidal Propeller for Low-Reynolds-Number Hovering Flight, AIAA JOURNAL, Volume: 57, Issue: 9, Pages: 3791-3800, ISSN: 0001-1452, eISSN: 1533-385X, 2019;	1.951 / Q2
12.	Berei, E., Stefanescu, O., Muntean, C., Taranu, B., Stefanescu, M. Study on the formation of CoCr2O4/SiO2 nanocomposite obtained from Co(II) carboxylate and ammonium dichromate, JOURNAL OF THERMAL ANALYSIS AND CALORIMETRY, Volume: 138, Issue: 3, Pages: 1863-1870, ISSN: 1388-6150, eISSN: 1588-2926, 2019;	2.471 / Q2
13.	Binzar, T., Pater, F., Nadaban, S. A Study of Boundedness in Fuzzy Normed Linear Spaces, SYMMETRY-BASEL, Volume: 11, Issue: 7, Article Number: 923, eISSN: 2073-8994, 2019;	2.143 / Q2
14.	Binzar, T., Burdak, Z., Lazureanu, C., Popovici, D., Slocinski, M. Wold-Slocinski decompositions for commuting isometric triples, JOURNAL OF MATHEMATICAL ANALYSIS AND APPLICATIONS, Volume: 472, Issue: 2, Pages: 1660-1677, ISSN: 0022-247X, eISSN: 1096-0813, 2019;	1.188 / Q1

No.	Article	2018 Impact Factor / Quartile in Category
15.	Blaga, R., Sabadus, A., Stefu, N., Dughir, C., Paulescu, M., Badescu, V. A current perspective on the accuracy of incoming solar energy forecasting, PROGRESS IN ENERGY AND COMBUSTION SCIENCE, Volume: 70, Pages: 119-144, ISSN: 0360-1285, eISSN: 1873-216X, 2019;	26.467 / Q1
16.	Boncalo, O., Kolumban-Antal, G., Amaricai, A., Savin, V., Declercq, D. Layered LDPC Decoders With Efficient Memory Access Scheduling and Mapping and Built-In Support for Pipeline Hazards Mitigation, IEEE TRANSACTIONS ON CIRCUITS AND SYSTEMS I-REGULAR PAPERS, Volume: 66, Issue: 4, Pages: 1643-1656, ISSN: 1549-8328, eISSN: 1558-0806, 2019;	3.934 / Q1
17.	Buse, C., O'Regan, D. A weak integral condition and its connections with existence and uniqueness of solutions for some abstract Cauchy problems in Banach spaces, MONATSHEFTE FUR MATHEMATIK, ISSN: 0026-9255, eISSN: 1436-5081, 2019;	0.807 / Q2
18.	Buse, C., O'Regan, D., Sailerli, O. Hyers-Ulam Stability for Linear Differences with Time Dependent and Periodic Coefficients, SYMMETRY-BASEL, Volume: 11, Issue: 4, Article Number: 512, eISSN: 2073-8994, 2019;	2.143 / Q2
19.	Buse, C., O'Regan, D., Sailerli, O. Hyers-Ulam Stability for Linear Differences with Time Dependent and Periodic Coefficients: The Case When the Monodromy Matrix Has Simple Eigenvalues, SYMMETRY-BASEL, Volume: 11, Issue: 3, Article Number: 339, ISSN: 2073-8994, 2019;	2.143 / Q2
20.	Capota, E.A., Stangaciu, C.S., Micea, M.V., Curici, D.I. Towards mixed criticality task scheduling in cyber physical systems: Challenges and perspectives, JOURNAL OF SYSTEMS AND SOFTWARE, Volume: 156, Pages: 204-216, ISSN: 0164-1212, eISSN: 1873-1228, 2019;	2.559 / Q1
21.	Caruntu, B., Bota, C., Lapadat, M., Pasca, M.S. Polynomial Least Squares Method for Fractional Lane-Emden Equations, SYMMETRY-BASEL, Volume: 11, Issue: 4, Article Number: 479, eISSN: 2073-8994, 2019;	2.143 / Q2
22.	Chieffo, N., Clementi, F., Formisano, A., Lenci, S. Comparative fragility methods for seismic assessment of masonry buildings located in Muccia (Italy), JOURNAL OF BUILDING ENGINEERING, Volume: 25, Article Number: UNSP 100813, ISSN: 2352-7102, 2019;	2.378 / Q2
23.	Chieffo, N., Formisano, A., Ferreira, T.M. Damage scenario-based approach and retrofitting strategies for seismic risk mitigation: an application to the historical Centre of Sant'Antimo (Italy), EUROPEAN JOURNAL OF ENVIRONMENTAL AND CIVIL ENGINEERING, Pages: 1-20, ISSN: 1964-8189, eISSN: 2116-7214, 2019;	1.873 / Q2
24.	Cioca, L.I., Ivascu, L., Turi, A., Artene, A., Gaman, G.A. Sustainable Development Model for the Automotive Industry, SUSTAINABILITY, Volume: 11, Issue: 22, Article Number: 6447, eISSN: 2071-1050, 2019;	2.592 / Q2
25.	Ciopec, M., Davidescu, C.M., Negrea, A., Duteanu, N., Rusu, G., Grad, O., Negrea, P. Amberlite XAD7 resin functionalized with crown ether and Fe(III) used for arsenic removal from water, PURE AND APPLIED CHEMISTRY, Volume: 91, Issue: 3, Pages: 375-388, ISSN: 0033-4545, eISSN: 1365-3075, 2019;	2.35 / Q2
26.	Cismas, E.C., Lupa, N. A Nash-Moser approach for the Euler-Arnold equations, MONATSHEFTE FUR MATHEMATIK, Volume: 192, Issue: 2, Pages: 333-353, ISSN: 0026-9255, eISSN: 1436-5081, 2019;	0.807 / Q2
27.	Coceci, L., Lupa, L., Lazau, R., Voda, R., Pode, R. Zinc recovery from waste zinc ash - A new "green" route for the preparation of Zn-Al layered double hydroxide used for molybdate retention, JOURNAL OF ALLOYS AND COMPOUNDS, Volume: 787, Pages: 332-343, ISSN: 0925-8388, eISSN: 1873-4669, 2019;	4.175 / Q1
28.	Cristea, M., Baul, B., Ledeti, I., Ledeti, A., Vlase, G., Vlase, T., Karolewicz, B., Stefanescu, O., Dragomirescu, A.O., Muresan, C., Cipu, D.S., Velimirovici, D., Stefanescu, M. Preformulation studies for atorvastatin calcium An instrumental approach, JOURNAL OF THERMAL ANALYSIS AND CALORIMETRY, Volume: 138, Issue: 4, Pages: 2799-2806, ISSN: 1388-6150, eISSN: 1588-2926, 2019;	2.471 / Q2

No.	Article	2018 Impact Factor / Quartile in Category
29.	Daianu, D.M., Mindruta, C. Polynomials of Arithmetically Homogeneous Functions: Stability and Hyperstability, RESULTS IN MATHEMATICS, Volume: 74, Issue: 1, Article Number: UNSP 59, ISSN: 1422-6383, eISSN: 1420-9012, 2019;	0.873 / Q2
30.	David, I., Orboi, M.D., Simandi, M.D., Chirila, C.A., Megyesi, C.I., Radulescu, L., Draghia, L.P., Lukinich-Gruia, A.T., Muntean, C., Hadaruga, D.I., Hadaruga, N.G. Fatty acid profile of Romanian's common bean (<i>Phaseolus vulgaris</i> L.) lipid fractions and their complexation ability by beta-cyclodextrin, PLOS ONE, Volume: 14, Issue: 11, Article Number: e0225474, PubMed ID: 31756198, ISSN: 1932-6203, 2019;	2.776 / Q2
31.	Davidescu, C.M., Ardelean, R., Popa, A. New polymeric adsorbent materials used for removal of phenolic derivatives from wastewaters, PURE AND APPLIED CHEMISTRY, Volume: 91, Issue: 3, Pages: 443-458, ISSN: 0033-4545, eISSN: 1365-3075, 2019;	2.35 / Q2
32.	Dolha, S., Negirla, P., Alexa, F., Silea, I. Considerations about the Signal Level Measurement in Wireless Sensor Networks for Node Position Estimation, SENSORS, Volume: 19, Issue: 19, Article Number: 4179, PubMed ID: 31561569, eISSN: 1424-8220, 2019;	3.031 / Q1
33.	Dubina, D., Marginean, I., Dinu, F. Impact modelling for progressive collapse assessment of selective rack systems, THIN-WALLED STRUCTURES, Volume: 143, Special Issue: SI, Article Number: UNSP 106201, ISSN: 0263-8231, eISSN: 1879-3223, 2019;	3.488 / Q1
34.	Duma, V.F., Sinescu, C., Bradu, A., Podoleanu, A. Optical Coherence Tomography Investigations and Modeling of the Sintering of Ceramic Crowns, MATERIALS, Volume: 12, Issue: 6, Article Number: 947, PubMed ID: 30901879, ISSN: 1996-1944, 2019;	2.972 / Q2
35.	Duma, V.F. Laser scanners with oscillatory elements: Design and optimization of 1D and 2D scanning functions, APPLIED MATHEMATICAL MODELLING, Volume: 67, Pages: 456-476, ISSN: 0307-904X, eISSN: 1872-8480, 2019;	2.841 / Q1
36.	Dumitru, R., Ianculescu, A., Pacurariu, C., Lupa, L., Pop, A., Vasile, B., Surdu, A., Manea, F. BiFeO ₃ -synthesis, characterization and its photocatalytic activity towards doxorubicin degradation from water, CERAMICS INTERNATIONAL, Volume: 45, Issue: 2, Special Issue: SI, Pages: 2789-2802, ISSN: 0272-8842, eISSN: 1873-3956, 2019;	3.45 / Q1
37.	Fagadar-Cosma, E., Vlascici, D., Birdeanu, M., Fagadar-Cosma, G. Novel fluorescent pH sensor based on 5-(4-carboxy-phenyl)-10,15,20-tris(phenyl)-porphyrin, ARABIAN JOURNAL OF CHEMISTRY, Volume: 12, Issue: 7, Pages: 1587-1594, ISSN: 1878-5352, eISSN: 1878-5379, 2019;	3.298 / Q2
38.	Frigura-Iliasa, F.M., Musuroi, S., Sorandaru, C., Vatau, D. New Technical Parameters and Operational Improvements of the Metal Oxide Varistors Manufacturing Process, PROCESSES, Volume: 7, Issue: 1, Article Number: 18, ISSN: 2227-9717, 2019;	1.963 / Q2
39.	Gheju, M., Balcu, I. Sustaining the efficiency of the Fe(0)/H ₂ O system for Cr(VI) removal by MnO ₂ amendment, CHEMOSPHERE, Volume: 214, Pages: 389-398, PubMed ID: 30268895, ISSN: 0045-6535, eISSN: 1879-1298, 2019;	5.108 / Q1
40.	Golban, A., Lupa, L., Cochei, L., Pode, R. Synthesis of MgFe Layered Double Hydroxide from Iron-Containing Acidic Residual Solution and Its Adsorption Performance, CRYSTALS, Volume: 9, Issue: 10, Article Number: 514, ISSN: 2073-4352, 2019;	2.061 / Q2
41.	Groza, B., Murvay, P.S. Identity-Based Key Exchange on In-Vehicle Networks: CAN-FD & FlexRay, SENSORS, Volume: 19, Issue: 22, Article Number: 4919, PubMed ID: 31718110, eISSN: 1424-8220, 2019;	3.031 / Q1

No.	Article	2018 Impact Factor / Quartile in Category
42.	Groza, B., Murvay, P.S. Efficient Intrusion Detection With Bloom Filtering in Controller Area Networks, IEEE TRANSACTIONS ON INFORMATION FORENSICS AND SECURITY, Volume: 14, Issue: 4, Pages: 1037-1051, ISSN: 1556-6013, eISSN: 1556-6021, 2019;	6.211 / Q1
43.	Groza, B., Popa, L., Murvay, P.S. TRICKS-Time TRiggered Covert Key Sharing for Controller Area Networks, IEEE ACCESS, Volume: 7, Pages: 104294-104307, ISSN: 2169-3536, 2019;	4.098 / Q1
44.	Hadaruga, N.G., Bandur, G.N., David, I., Hadaruga, D.I. A review on thermal analyses of cyclodextrins and cyclodextrin complexes, ENVIRONMENTAL CHEMISTRY LETTERS, Volume: 17, Issue: 1, Pages: 349-373, ISSN: 1610-3653, eISSN: 1610-3661, 2019;	4.617 / Q1
45.	Halbac-Cotoara-Zamfir, R., Keesstra, S., Kalantari, Z. The impact of political, socio-economic and cultural factors on implementing environment friendly techniques for sustainable land management and climate change mitigation in Romania, SCIENCE OF THE TOTAL ENVIRONMENT, Volume: 654, Pages: 418-429, PubMed ID: 30447580, ISSN: 0048-9697, eISSN: 1879-1026, 2019;	5.589 / Q1
46.	Hedrea, C. The Lie-Trotter integrator in the dynamics of a mechanical system, JOURNAL OF GEOMETRY AND PHYSICS, Volume: 145, Article Number: UNSP 103470, ISSN: 0393-0440, eISSN: 1879-1662, 2019;	0.806 / Q2
47.	Ianasi, C., Piciorus, M., Nicola, R., Ciopec, M., Negrea, A., Niznansky, D., Len, A., Almasy, L., Putz, A.M. Removal of cadmium from aqueous solutions using inorganic porous nanocomposites, KOREAN JOURNAL OF CHEMICAL ENGINEERING, Volume: 36, Issue: 5, Pages: 688-700, ISSN: 0256-1115, eISSN: 1975-7220, 2019;	2.476 / Q2
48.	Islam, F., Bhattacharya, B., Popescu, I. Flood risk assessment due to cyclone-induced dike breaching in coastal areas of Bangladesh, NATURAL HAZARDS AND EARTH SYSTEM SCIENCES, Volume: 19, Issue: 2, Pages: 353-368, ISSN: 1561-8633, 2019;	2.883 / Q1
49.	Istratie, R., Stoia, M., Pacurariu, C., Locovei, C. Single and simultaneous adsorption of methyl orange and phenol onto magnetic iron oxide/carbon nanocomposites, ARABIAN JOURNAL OF CHEMISTRY, Volume: 12, Issue: 8, Pages: 3704-3722, ISSN: 1878-5352, eISSN: 1878-5379, 2019;	3.298 / Q2
50.	Kang, S.H., Tiwari, A.K., Albulescu, C.T., Yoon, S.M. Exploring the time-frequency connectedness and network among crude oil and agriculture commodities V1, ENERGY ECONOMICS, Volume: 84, Article Number: UNSP 104543, ISSN: 0140-9883, eISSN: 1873-6181, 2019;	4.151 / Q1
51.	Kang, S.H., Tiwari, A.K., Albulescu, C.T., Yoon, S.M. Time-frequency co-movements between the largest nonferrous metal futures markets, RESOURCES POLICY, Volume: 61, Pages: 393-398, ISSN: 0301-4207, eISSN: 1873-7641, 2019;	3.185 / Q2
52.	Lemle, L.D. On the L-infinity-Uniqueness of Dynamical Systems with Small Random Perturbation, RESULTS IN MATHEMATICS, Volume: 74, Issue: 1, Article Number: UNSP 26, ISSN: 1422-6383, eISSN: 1420-9012, 2019;	0.873 / Q2
53.	Linul, E., Lell, D., Movahedi, N., Codrean, C., Fiedler, T. Compressive properties of zinc syntactic foams at elevated temperatures, COMPOSITES PART B-ENGINEERING, Volume: 167, Pages: 122-134, ISSN: 1359-8368, eISSN: 1879-1069, 2019;	6.864 / Q1
54.	Linul, E., Marsavina, L., Linul, P.A., Kovacic, J. Cryogenic and high temperature compressive properties of Metal Foam Matrix Composites, COMPOSITE STRUCTURES, Volume: 209, Pages: 490-498, ISSN: 0263-8223, eISSN: 1879-1085, 2019;	4.829 / Q1

No.	Article	2018 Impact Factor / Quartile in Category
55.	Luca, R.E., Todea, C.D., Duma, V.F., Bradu, A., Podoleanu, A.G. Quantitative assessment of rat bone regeneration using complex master-slave optical coherence tomography, <i>QUANTITATIVE IMAGING IN MEDICINE AND SURGERY</i> , Volume: 9, Issue: 5, Special Issue: SI, Pages: 782-798, PubMed ID: 31281774, ISSN: 2223-4292, eISSN: 2223-4306, 2019;	3.074 / Q2
56.	Maranescu, B., Lupa, L., Visa, A. Synthesis, characterization and rare earth elements adsorption properties of phosphonate metal organic frameworks, <i>APPLIED SURFACE SCIENCE</i> , Volume: 481, Pages: 83-91, ISSN: 0169-4332, eISSN: 1873-5584, 2019;	5.155 / Q1
57.	Marsavina, L., Iacoviello, F., Pirvulescu, L.D., Di Cocco, V., Rusu, L. Engineering prediction of fatigue strength for AM50 magnesium alloys, <i>INTERNATIONAL JOURNAL OF FATIGUE</i> , Volume: 127, Pages: 10-15, ISSN: 0142-1123, eISSN: 1879-3452, 2019;	3.673 / Q1
58.	Matekovits, L., de Sabata, A., Silaghi, A.M. Frequency Selective Surface With Two Quasi-Independent Notch Frequencies, <i>IEEE ACCESS</i> , Volume: 7, Pages: 77261-77267, ISSN: 2169-3536, 2019;	4.098 / Q1
59.	Miclau, M., Kumar, S., Ursu, D., Orha, C., Miclau, N., Rueff, J.M., Malo, S., Martin, C. Ag ₂ CrO ₄ for photocatalytic applications: High performance of crystals designed by autogenous pressure, <i>MATERIALS CHARACTERIZATION</i> , Volume: 158, Article Number: 109970, ISSN: 1044-5803, eISSN: 1873-4189, 2019;	3.22 / Q1
60.	Mihailescu, M., Negrea, A., Ciopec, M., Davidescu, C.M., Negrea, P., Duteanu, N., Rusu, G. Gold (III) adsorption from dilute waste solutions onto Amberlite XAD7 resin modified with L-glutamic acid, <i>SCIENTIFIC REPORTS</i> , Volume: 9, Article Number: 8757, PubMed ID: 31217435, ISSN: 2045-2322, 2019;	4.011 / Q1
61.	Milici, C., Machado, J.T., Draganescu, G. On the fractional Cornu spirals, <i>COMMUNICATIONS IN NONLINEAR SCIENCE AND NUMERICAL SIMULATION</i> , Volume: 67, Pages: 100-107, ISSN: 1007-5704, eISSN: 1878-7274, 2019;	3.967 / Q1
62.	Minzatu, V., Davidescu, C.M., Negrea, P., Ciopec, M., Muntean, C., Hulka, I., Paul, C., Negrea, A., Duteanu, N. Synthesis, Characterization and Adsorptive Performances of a Composite Material Based on Carbon and Iron Oxide Particles, <i>INTERNATIONAL JOURNAL OF MOLECULAR SCIENCES</i> , Volume: 20, Issue: 7, Article Number: 1609, PubMed ID: 30935127, ISSN: 1422-0067, 2019;	4.183 / Q2
63.	Mitelea, I., Bena, T., Bordeasu, I., Utu, I.D., Craciunescu, C.M. Enhancement of Cavitation Erosion Resistance of Cast Iron with TIG Remelted Surface, <i>METALLURGICAL AND MATERIALS TRANSACTIONS A-PHYSICAL METALLURGY AND MATERIALS SCIENCE</i> , Volume: 50A, Issue: 8, Pages: 3767-3775, ISSN: 1073-5623, eISSN: 1543-1940, 2019;	1.985 / Q1
64.	Moaca, E.A., Farcas, C., Coricovact, D., Avram, S., Mihali, C.V., Draghici, G.A., Loghin, F., Pacurariu, C., Dehelean, C. Oleic Acid Double Coated Fe ₃ O ₄ Nanoparticles as Anti-Melanoma Compounds with a Complex Mechanism of Activity-In Vitro and In Ovo Assessment, <i>JOURNAL OF BIOMEDICAL NANOTECHNOLOGY</i> , Volume: 15, Issue: 5, Pages: 893-909, PubMed ID: 30890222, ISSN: 1550-7033, eISSN: 1550-7041, 2019;	5.068 / Q1
65.	Moaca, E.A., Mihali, C.V., Macasoi, I.G., Racoviceanu, R., Soica, C., Dehelean, C.A., Pacurariu, C., Florescu, S. Fe ₃ O ₄ @C Matrix with Tailorable Adsorption Capacities for Paracetamol and Acetylsalicylic Acid: Synthesis, Characterization, and Kinetic Modeling, <i>MOLECULES</i> , Volume: 24, Issue: 9, PubMed ID: 31058855, eISSN: 1420-3049, 2019;	3.06 / Q2
66.	Mosoarca, M., Onescu, I., Onescu, E., Azap, B., Chieffo, N., Szitar-Sirbu, M. Seismic vulnerability assessment for the historical areas of the Timisoara city, Romania, <i>ENGINEERING FAILURE ANALYSIS</i> , Volume: 101, Pages: 86-112, ISSN: 1350-6307, eISSN: 1873-1961, 2019;	2.203 / Q2
67.	Mosoarca, M., Keller, A.I., Bocan, C. Failure analysis of church towers and roof structures due to high wind velocities, <i>ENGINEERING FAILURE ANALYSIS</i> , Volume: 100, Pages: 76-87, ISSN: 1350-6307, eISSN: 1873-1961, 2019;	2.203 / Q2

No.	Article	2018 Impact Factor / Quartile in Category
68.	Mosoiu, C., Vlase, D., Vlase, G., Lazau, R., Vlase, T. TG-DTA and FTIR analyses of roman and later historic mortars from Drobeta-Turnu Severin region, <i>JOURNAL OF THERMAL ANALYSIS AND CALORIMETRY</i> , Volume: 138, Issue: 3, Pages: 2159-2166, ISSN: 1388-6150, eISSN: 1588-2926, 2019;	2.471 / Q2
69.	Motoc, S., Cretu, C., Costisor, O., Baci, A., Manea, F., Szerb, E.I. Cu(II) Coordination Complex Precursor for Randomized CuOx Microarray Loaded on Carbon Nanofiber with Excellent Electrocatalytic Performance for Electrochemical Glucose Detection, <i>SENSORS</i> , Volume: 19, Issue: 24, Article Number: 5353, PubMed ID: 31817245, eISSN: 1424-8220, 2019;	3.031 / Q1
70.	Motoc, S., Manea, F., Orha, C., Pop, A. Enhanced Electrochemical Response of Diclofenac at a Fullerene-Carbon Nanofiber Paste Electrode, <i>SENSORS</i> , Volume: 19, Issue: 6, Article Number: 1332, PubMed ID: 30884875, ISSN: 1424-8220, 2019;	3.031 / Q1
71.	Muntean, S.G., Nistor, M.A., Ianos, R., Pacurariu, C., Capraru, A., Surdu, V.A. Combustion synthesis of Fe ₃ O ₄ /Ag/C nanocomposite and application for dyes removal from multicomponent systems, <i>APPLIED SURFACE SCIENCE</i> , Volume: 481, Pages: 825-837, ISSN: 0169-4332, eISSN: 1873-5584, 2019;	5.155 / Q1
72.	Nichita, I., Lupa, L., Stoia, M., Dragan, E.S., Popa, A. Aminophosphonic groups grafted onto the structure of macroporous styrene-divinylbenzene copolymer: preparation and studies on the antimicrobial effect, <i>POLYMER BULLETIN</i> , Volume: 76, Issue: 9, Pages: 4539-4557, ISSN: 0170-0839, eISSN: 1436-2449, 2019;	1.858 / Q2
73.	Nicola, R., Costisor, O., Muntean, S.G., Nistor, M.A., Putz, A.M., Ianasi, C., Lazau, R., Almasy, L., Sacarescu, L. Mesoporous magnetic nanocomposites: a promising adsorbent for the removal of dyes from aqueous solutions, <i>JOURNAL OF POROUS MATERIALS</i> , Volume: 27, Issue: 2, Pages: 413-428, ISSN: 1380-2224, eISSN: 1573-4854, 2019;	1.947 / Q2
74.	Nicolae, A., Korodi, A., Silea, I. Identifying Data Dependencies as First Step to Obtain a Proactive Historian: Test Scenario in the Water Industry 4.0, <i>WATER</i> , Volume: 11, Issue: 6, ISSN: 2073-4441, 2019;	2.524 / Q2
75.	Pana, A.M., Gherman, V., Sfirloaga, P., Rusu, G., Bandur, G., Popa, M., Rusnac, L.M., Dumitrel, G.A. Biodegradation studies on new glycopolymers derived from oligomeric D-mannose itaconates and 2-hydroxypropyl acrylate, <i>POLYMER DEGRADATION AND STABILITY</i> , Volume: 167, Pages: 210-216, ISSN: 0141-3910, eISSN: 1873-2321, 2019;	3.78 / Q1
76.	Patrinoiu, G., Dumitru, R., Culita, D.C., Munteanu, C., Birjega, R., Calderon-Moreno, J.M., Cucos, A., Pelinescu, D., Chifiriuc, M.C., Bleotu, C., Carp, O. Self-assembled zinc oxide hierarchical structures with enhanced antibacterial properties from stacked chain-like zinc oxalate compounds, <i>JOURNAL OF COLLOID AND INTERFACE SCIENCE</i> , Volume: 552, Pages: 258-270, PubMed ID: 31129297, ISSN: 0021-9797, eISSN: 1095-7103, 2019;	6.361 / Q1
77.	Pauseanu, I., Todea, A., Badea, V., Peter, F., Medeleanu, M., Ledeti, I., Vlase, G., Vlase, T. Optical and thermal properties of intelligent pH indicator films based on chitosan/PVA and a new xanthylum dye, <i>JOURNAL OF THERMAL ANALYSIS AND CALORIMETRY</i> , ISSN: 1388-6150, eISSN: 1588-2926, 2019;	2.471 / Q2
78.	Peyghami, S., Davari, P., Fotuhi-Firuzabad, M., Blaabjerg, F. Standard Test Systems for Modern Power System Analysis An Overview, <i>IEEE INDUSTRIAL ELECTRONICS MAGAZINE</i> , Volume: 13, Issue: 4, Pages: 86-105, ISSN: 1932-4529, eISSN: 1941-0115, 2019;	13.241 / Q1
79.	Poletti, E., Vasconcelos, G., Branco, J.M., Isopescu, B. Effects of extreme environmental exposure conditions on the mechanical behaviour of traditional carpentry joints, <i>CONSTRUCTION AND BUILDING MATERIALS</i> , Volume: 213, Pages: 61-78, ISSN: 0950-0618, eISSN: 1879-0526, 2019;	4.046 / Q1
80.	Radac, M.B., Precup, R.E. Data-Driven Model-Free Tracking Reinforcement Learning Control with VRFT-based Adaptive Actor-Critic, <i>APPLIED SCIENCES-BASEL</i> , Volume: 9, Issue: 9, Article Number: 1807, eISSN: 2076-3417, 2019;	2.217 / Q2

No.	Article	2018 Impact Factor / Quartile in Category
81.	Rajak, D.K., Mahajan, N.N., Linul, E. Crashworthiness performance and microstructural characteristics of foam-filled thin-walled tubes under diverse strain rate, JOURNAL OF ALLOYS AND COMPOUNDS, Volume: 775, Pages: 675-689, ISSN: 0925-8388, eISSN: 1873-4669, 2019;	4.175 / Q1
82.	Rajak, D.K., Pagar, D.D., Menezes, P.L., Linul, E. Fiber-Reinforced Polymer Composites: Manufacturing, Properties, and Applications, POLYMERS, Volume: 11, Issue: 10, Article Number: 1667, PubMed ID: 31614875, eISSN: 2073-4360, 2019;	3.164 / Q1
83.	Reisz, E., Tekle-Roettering, A., Naumov, S., Schmidt, W., Schmidt, T.C. Reaction of 1-propanol with Ozone in Aqueous Media, INTERNATIONAL JOURNAL OF MOLECULAR SCIENCES, Volume: 20, Issue: 17, PubMed ID: 31454911, eISSN: 1422-0067, 2019;	4.183 / Q2
84.	Sarbu, I., Mirza, M., Crasmareanu, E. A review of modelling and optimisation techniques for district heating systems, INTERNATIONAL JOURNAL OF ENERGY RESEARCH, Volume: 43, Issue: 13, Pages: 6572-6598, ISSN: 0363-907X, eISSN: 1099-114X, 2019;	3.343 / Q1
85.	Sarbu, I., Dorca, A. Review on heat transfer analysis in thermal energy storage using latent heat storage systems and phase change materials, INTERNATIONAL JOURNAL OF ENERGY RESEARCH, Volume: 43, Issue: 1, Pages: 29-64, ISSN: 0363-907X, eISSN: 1099-114X, 2019;	3.343 / Q1
86.	Scorza, D., Marsavina, L., Carpinteri, A., Ronchei, C., Vantadori, S. Size-effect independence of particleboard fracture toughness, COMPOSITE STRUCTURES, Volume: 229, Article Number: UNSP 111374, ISSN: 0263-8223, eISSN: 1879-1085, 2019;	4.829 / Q1
87.	Seclaman, E., Balacescu, L., Balacescu, O., Bejinar, C., Udrescu, M., Marian, C., Sirbu, I.O., Anghel, A. MicroRNAs mediate liver transcriptome changes upon soy diet intervention in mice, JOURNAL OF CELLULAR AND MOLECULAR MEDICINE, Volume: 23, Issue: 3, Pages: 2263-2267, PubMed ID: 30618122, eISSN: 1582-4934, 2019;	4.658 / Q1
88.	Serafim, V., Chirita-Emandi, A., Andreescu, N., Tiugan, D.A., Tutac, P., Paul, C., Velea, I., Mihailescu, A., Serban, C.L., Zimbru, C.G., Puiu, M., Niculescu, M.D. Single Nucleotide Polymorphisms in PEMT and MTHFR Genes are Associated with Omega 3 and 6 Fatty Acid Levels in the Red Blood Cells of Children with Obesity, NUTRIENTS, Volume: 11, Issue: 11, Article Number: 2600, PubMed ID: 31671528, eISSN: 2072-6643, 2019;	4.171 / Q1
89.	Sora, I., Chirila, C.B. Finding key classes in object-oriented software systems by techniques based on static analysis, INFORMATION AND SOFTWARE TECHNOLOGY, Volume: 116, Article Number: UNSP 106176, ISSN: 0950-5849, eISSN: 1873-6025, 2019;	2.921 / Q1
90.	Sorandaru, C., Musuroi, S., Frigura-Iliasa, F.M., Vatau, D., Dordescu, M. Analysis of the Wind System Operation in the Optimal Energetic Area at Variable Wind Speed over Time, SUSTAINABILITY, Volume: 11, Issue: 5, Article Number: 1249, ISSN: 2071-1050, 2019;	2.592 / Q2
91.	Stavi, I., Gusarov, Y., Halbac-Cotoara-Zamfir, R. Collapse and failure of ancient agricultural stone terraces: On-site geomorphic processes, pedogenic mechanisms, and soil quality, GEODERMA, Volume: 344, Pages: 144-152, ISSN: 0016-7061, eISSN: 1872-6259, 2019;	4.336 / Q1
92.	Stefanescu, M., Muntean, C., Berei, E., Vlase, T., Stefanescu, O. Preparation and characterization of CuCr2O4/SiO2 and Cu2Cr2O4/SiO2 nanocomposites obtained from carboxylate complex combinations, JOURNAL OF THERMAL ANALYSIS AND CALORIMETRY, Volume: 138, Issue: 3, Pages: 1887-1894, ISSN: 1388-6150, eISSN: 1588-2926, 2019;	2.471 / Q2
93.	Stoia, D.I., Marsavina, L., Linul, E. Correlations between Process Parameters and Outcome Properties of Laser-Sintered Polyamide, POLYMERS, Volume: 11, Issue: 11, Article Number: 1850, PubMed ID: 31717539, eISSN: 2073-4360, 2019;	3.164 / Q1

No.	Article	2018 Impact Factor / Quartile in Category
94.	Stoia, D.I., Linul, E., Marsavina, L. Influence of Manufacturing Parameters on Mechanical Properties of Porous Materials by Selective Laser Sintering, <i>MATERIALS</i> , Volume: 12, Issue: 6, Article Number: 871, PubMed ID: 30875894, ISSN: 1996-1944, 2019;	2.972 / Q2
95.	Stoia, M., Pacurariu, C., Mihali, C., Malaescu, I., Marin, C.N., Capraru, A. Manganese ferrite-polyaniline hybrid materials: Electrical and magnetic properties, <i>CERAMICS INTERNATIONAL</i> , Volume: 45, Issue: 2, Special Issue: SI, Pages: 2725-2735, ISSN: 0272-8842, eISSN: 1873-3956, 2019;	3.45 / Q1
96.	Tanasa, C., Bosioc, A., Muntean, S., Susan-Resiga, R. A Novel Passive Method to Control the Swirling Flow with Vortex Rope from the Conical Diffuser of Hydraulic Turbines with Fixed Blades, <i>APPLIED SCIENCES-BASEL</i> , Volume: 9, Issue: 22, Article Number: 4910, eISSN: 2076-3417, 2019;	2.217 / Q2
97.	Taucean, I.M., Tamasila, M., Ivascu, L., Miclea, S., Negrut, M. Integrating Sustainability and Lean: SLIM Method and Enterprise Game Proposed, <i>SUSTAINABILITY</i> , Volume: 11, Issue: 7, Article Number: 2103, ISSN: 2071-1050, 2019;	2.592 / Q2
98.	Tidrea, A., Korodi, A., Silea, I. Cryptographic Considerations for Automation and SCADA Systems Using Trusted Platform Modules, <i>SENSORS</i> , Volume: 19, Issue: 19, Article Number: 4191, PubMed ID: 31569636, eISSN: 1424-8220, 2019;	3.031 / Q1
99.	Todea, A., Bitcan, I., Aparaschivei, D., Pausescu, I., Badea, V., Peter, F., Gherman, V.D., Rusu, G., Nagy, L., Keki, S. Biodegradable Oligoesters of epsilon-Caprolactone and 5-Hydroxymethyl-2-Furancarboxylic Acid Synthesized by Immobilized Lipases, <i>POLYMERS</i> , Volume: 11, Issue: 9, Article Number: 1402, PubMed ID: 31455024, eISSN: 2073-4360, 2019;	3.164 / Q1
100.	Ursu, D., Vajda, M., Miclau, M. Investigation of the p-type dye-sensitized solar cell based on full Cu ₂ O electrodes, <i>JOURNAL OF ALLOYS AND COMPOUNDS</i> , Volume: 802, Pages: 86-92, ISSN: 0925-8388, eISSN: 1873-4669, 2019;	4.175 / Q1
101.	Vares, S., Hradil, P., Sansom, M., Ungureanu, V. Economic potential and environmental impacts of reused steel structures, <i>STRUCTURE AND INFRASTRUCTURE ENGINEERING</i> , Volume: 16, Issue: 4, Special Issue: SI, Pages: 750-761, ISSN: 1573-2479, eISSN: 1744-8980, 2019;	2.43 / Q2
102.	Vasilescu, C., Todea, A., Nan, A., Circu, M., Turcu, R., Benea, I.C., Peter, F. Enzymatic synthesis of short-chain flavor esters from natural sources using tailored magnetic biocatalysts, <i>FOOD CHEMISTRY</i> , Volume: 296, Pages: 1-8, PubMed ID: 31202292, ISSN: 0308-8146, eISSN: 1873-7072, 2019;	5.399 / Q1
103.	Venturini, A.B., Assumpcao, T.H., Popescu, I., Jonoski, A., Solomatine, D.P. Modelling support to citizen observatories for strategic Danube Delta planning: Sontea-Fortuna case study, <i>JOURNAL OF ENVIRONMENTAL PLANNING AND MANAGEMENT</i> , Volume: 62, Issue: 11, Pages: 1972-1989, ISSN: 0964-0568, eISSN: 1360-0559, 2019;	1.855 / Q2
104.	Vintila, T., Ionel, I., Fregue, T.T.R., Wachter, A.R., Julean, C., Gabche, A.S. Residual Biomass from Food Processing Industry in Cameroon as Feedstock for Second-generation Biofuels, <i>BIORESOURCES</i> , Volume: 14, Issue: 2, Pages: 3731-3745, ISSN: 1930-2126, 2019;	1.396 / Q2
105.	Vlase, D., Rogozea, O., Mosoiu, C., Vlase, G., Lazau, R., Vlase, T. Thermoanalytical investigations of some ceramics dated from the Neolithic period, discovered at Oxenbrickel, Sanandrei, Romania, <i>JOURNAL OF THERMAL ANALYSIS AND CALORIMETRY</i> , Volume: 138, Issue: 3, Pages: 2145-2157, ISSN: 1388-6150, eISSN: 1588-2926, 2019;	2.471 / Q2
106.	Voda, M., Codrean, C., Chicot, D., Serban, V.A., Utu, D., Linul, E., Buzdugan, D. Characterization of brazed joints by electrical resistance spot brazing with Ni-based amorphous self-flux alloys, <i>JOURNAL OF MANUFACTURING PROCESSES</i> , Volume: 37, Pages: 617-627, ISSN: 1526-6125, 2019;	3.462 / Q2

No.

Article

2018 Impact Factor /
Quartile in Category

107. Xiao, D., Heaney, C.E., Fang, F., Mottet, L., Hu, R., Bistran, D.A., Aristodemou, E., Navon, I.M., Pain, C.C. A domain decomposition non-intrusive reduced order model for turbulent flows, COMPUTERS & FLUIDS, Volume: 182, Pages: 15-27, ISSN: 0045-7930, eISSN: 1879-0747, 2019.

2.223 / Q2

* The data was obtained from Web of Science - Clarivate Analytics in 22 June 2020

Papers in ISI Journals

1. Achiriloaiei, D., Medeleanu, M. Studies on the Effects of Environmental Pollution on ACSR Conductors, REVISTA DE CHIMIE, Volume: 70, Issue: 11, Pages: 3984-3986, ISSN: 0034-7752, 2019;
2. Ahmadi, M., Pet, I., Stef, L., Dumitrescu, G., Patruica, S., Nicula, M., Ciochina, L.P., Popa, M., Dronca, D. Blood Serum Minerals - in vivo Mineral Interactions Following Iron Overload, REVISTA DE CHIMIE, Volume: 70, Issue: 11, Pages: 4073-4076, ISSN: 0034-7752, 2019;
3. Ahmed, B., Dinu, F., Marginean, I. Damage Characterization in Building Structures Due to Blast Actions, JORDAN JOURNAL OF CIVIL ENGINEERING, Volume: 13, Issue: 4, Pages: 538-570, ISSN: 1993-0461, eISSN: 2225-157X, 2019;
4. Albu, A., Precup, R.E., Teban, T.A. RESULTS AND CHALLENGES OF ARTIFICIAL NEURAL NETWORKS USED FOR DECISION-MAKING AND CONTROL IN MEDICAL APPLICATIONS, FACTA UNIVERSITATIS-SERIES MECHANICAL ENGINEERING, Volume: 17, Issue: 3, Pages: 285-308, ISSN: 0354-2025, eISSN: 2335-0164, 2019;
5. Albulescu, C.T., Pepin, D. The money demand and the loss of interest for the euro in Romania, APPLIED ECONOMICS LETTERS, Volume: 26, Issue: 3, Pages: 196-201, ISSN: 1350-4851, eISSN: 1466-4291, 2019;
6. Albulescu, C.T., Tiwari, A.K., Miller, S.M., Gupta, R. Time-frequency relationship between US inflation and inflation uncertainty: evidence from historical data, SCOTTISH JOURNAL OF POLITICAL ECONOMY, Volume: 66, Issue: 5, Pages: 673-702, ISSN: 0036-9292, eISSN: 1467-9485, 2019;
7. Albulescu, C.T., Tiwari, A.K., Yoon, S.M., Kang, S.H. FDI, income, and environmental pollution in Latin America: Replication and extension using panel quantiles regression analysis, ENERGY ECONOMICS, Volume: 84, Article Number: UNSP 104504, ISSN: 0140-9883, eISSN: 1873-6181, 2019;
8. Albulescu, C.T., Demirer, R., Raheem, I.D., Tiwari, A.K. Does the US economic policy uncertainty connect financial markets? Evidence from oil and commodity currencies, ENERGY ECONOMICS, Volume: 83, Pages: 375-388, ISSN: 0140-9883, eISSN: 1873-6181, 2019;
9. Albulescu, C.T., Pepin, D., Miller, S.M. The micro-foundations of an open economy money demand: An application to central and eastern European countries, JOURNAL OF MACROECONOMICS, Volume: 60, Pages: 33-45, ISSN: 0164-0704, eISSN: 1873-152X, 2019;
10. Aliha, M.R.M., Mousavi, S.S., Bahmani, A., Linul, E., Marsavina, L. Crack initiation angles and propagation paths in polyurethane foams under mixed modes I/II and I/III loading, THEORETICAL AND APPLIED FRACTURE MECHANICS, Volume: 101, Pages: 152-161, ISSN: 0167-8442, eISSN: 1872-7638, 2019;
11. Ancuti, C.O., Ancuti, C., De Vleeschouwer, C., Sbet, M. Color Channel Transfer for Image Dehazing, IEEE SIGNAL PROCESSING LETTERS, Volume: 26, Issue: 10, Pages: 1413-1417, ISSN: 1070-9908, eISSN: 1558-2361, 2019;
12. Anghel, A.A., Mohora, I., Preda, A.D., Giurea, D., Frigura-Iliasa, F.M. ENVIRONMENTAL TENDENCIES IN MODULAR GREEN INSTALLATIONS, JOURNAL OF GREEN BUILDING, Volume: 14, Issue: 4, Pages: 197-221, ISSN: 1552-6100, eISSN: 1943-4618, 2019;
13. Antoniac, I.V., Stoia, D.I., Ghiban, B., Tecu, C., Miculescu, F., Vigar, C., Saceleanu, V. Failure Analysis of a Humeral Shaft Locking Compression Plate Surface Investigation and Simulation by Finite Element Method, MATERIALS, Volume: 12, Issue: 7, Article Number: 1128, PubMed ID: 30959903, ISSN: 1996-1944, 2019;
14. Anwar, G.A., Dinu, F., Ahmed, M. Numerical Study on Ultimate Deformation and Resistance Capacity of Bolted T-Stub Connection, INTERNATIONAL JOURNAL OF STEEL STRUCTURES, Volume: 19, Issue: 3, Pages: 970-977, ISSN: 1598-2351, eISSN: 2093-6311, 2019;
15. Aparaschivei, D., Todea, A., Frissen, A.E., Badea, V., Rusu, G., Sisu, E., Puiu, M., Boeriu, C.G., Peter, F. Enzymatic synthesis and characterization of novel terpolymers from renewable sources, PURE AND APPLIED CHEMISTRY, Volume: 91, Issue: 3, Pages: 397-408, ISSN: 0033-4545, eISSN: 1365-3075, 2019;
16. Apostol, C., Butu, M., Stancel, C.D., Niculescu, F., Duma, S.T., Bud, F. STUDIES ON THE FLUX TREATMENT OF SECONDARY ALUMINIUM ALLOYS OBTAINED AT LOW TEMPERATURES, UNIVERSITY POLITEHNICA OF BUCHAREST SCIENTIFIC BULLETIN SERIES B-CHEMISTRY AND MATERIALS SCIENCE, Volume: 81, Issue: 2, Pages: 197-206, ISSN: 1454-2331, 2019;
17. Ates, M., Kar, B., Bogatu, C. CHARACTERIZATION OF ERBIUM OXIDE NANOPARTICLES, FRESenius ENVIRONMENTAL BULLETIN, Volume: 28, Issue: 12A, Pages: 10181-10185, ISSN: 1018-4619, eISSN: 1610-2304, 2019;

18. Avram, S., Udrea, A.M., Negrea, A., Ciopec, M., Duteanu, N., Postolache, C., Duda-Seiman, C., Duda-Seiman, D., Shaposhnikov, S. Prevention of Deficit in Neuropsychiatric Disorders through Monitoring of Arsenic and Its Derivatives as Well as Through Bioinformatics and Cheminformatics, *INTERNATIONAL JOURNAL OF MOLECULAR SCIENCES*, Volume: 20, Issue: 8, Article Number: 1804, PubMed ID: 31013686, eISSN: 1422-0067, 2019;
19. Baba, M., Gui, V., Cernazanu, C., Pescaru, D. A Sensor Network Approach for Violence Detection in Smart Cities Using Deep Learning, *SENSORS*, Volume: 19, Issue: 7, Article Number: 1676, PubMed ID: 30965646, eISSN: 1424-8220, 2019;
20. Baniias, O. Test case selection-prioritization approach based on memoization dynamic programming algorithm, *INFORMATION AND SOFTWARE TECHNOLOGY*, Volume: 115, Pages: 119-130, ISSN: 0950-5849, eISSN: 1873-6025, 2019;
21. Baniias, O., Milincu, C.O. Hybrid Design Tools-Image Quality Assessment of a Digitally Augmented Blackboard Integrated System, *INFORMATICS-BASEL*, Volume: 6, Issue: 1, Article Number: 6, eISSN: 2227-9709, 2019;
22. Barina, G., Udrescu, M., Barina, A., Topirceanu, A., Vladutiu, M. Agent-based simulations of payoff distribution in economic networks, *SOCIAL NETWORK ANALYSIS AND MINING*, Volume: 9, Issue: 1, Article Number: 63, ISSN: 1869-5450, eISSN: 1869-5469, 2019;
23. Belega, D., Petri, D. Influence of the noise on DFT-based sine-wave frequency and amplitude estimators, *MEASUREMENT*, Volume: 137, Pages: 527-534, ISSN: 0263-2241, eISSN: 1873-412X, 2019;
24. Berechet, M., Mirel, I., Staniloiu, C., Fischer, K. CARBON FOOTPRINT OF WASTE MANAGEMENT IN ROMANIA IN THE CONTEXT OF CIRCULAR ECONOMY, *ENVIRONMENTAL ENGINEERING AND MANAGEMENT JOURNAL*, Volume: 18, Issue: 6, Pages: 1289-1295, ISSN: 1582-9596, eISSN: 1843-3707, 2019;
25. Berezcky, F., Silea, I. New Nature-Inspired Cycloidal Propeller for Low-Reynolds-Number Hovering Flight, *AIAA JOURNAL*, Volume: 57, Issue: 9, Pages: 3791-3800, ISSN: 0001-1452, eISSN: 1533-385X, 2019;
26. Berei, E., Stefanescu, O., Muntean, C., Taranu, B., Stefanescu, M. Study on the formation of CoCr2O4/SiO2 nanocomposite obtained from Co(II) carboxylate and ammonium dichromate, *JOURNAL OF THERMAL ANALYSIS AND CALORIMETRY*, Volume: 138, Issue: 3, Pages: 1863-1870, ISSN: 1388-6150, eISSN: 1588-2926, 2019;
27. Binzar, T., Pater, F., Nadaban, S. A Study of Boundedness in Fuzzy Normed Linear Spaces, *SYMMETRY-BASEL*, Volume: 11, Issue: 7, Article Number: 923, eISSN: 2073-8994, 2019;
28. Binzar, T., Burdak, Z., Lazureanu, C., Popovici, D., Slocinski, M. Wold-Slocinski decompositions for commuting isometric triples, *JOURNAL OF MATHEMATICAL ANALYSIS AND APPLICATIONS*, Volume: 472, Issue: 2, Pages: 1660-1677, ISSN: 0022-247X, eISSN: 1096-0813, 2019;
29. Blaga, R., Sabadus, A., Stefu, N., Dughir, C., Paulescu, M., Badescu, V. A current perspective on the accuracy of incoming solar energy forecasting, *PROGRESS IN ENERGY AND COMBUSTION SCIENCE*, Volume: 70, Pages: 119-144, ISSN: 0360-1285, eISSN: 1873-216X, 2019;
30. Birtok-Baneasa, C., Budiul-Berghian, A., Socalici, V.A., Bucevschi, R. Simulation of Thermal Transfer Through the Polyamide Intake Manifold, *MATERIALE PLASTICE*, Volume: 56, Issue: 1, Pages: 191-194, ISSN: 0025-5289, 2019;
31. Boncalo, O., Kolumban-Antal, G., Amaricai, A., Savin, V., Declercq, D. Layered LDPC Decoders With Efficient Memory Access Scheduling and Mapping and Built-In Support for Pipeline Hazards Mitigation, *IEEE TRANSACTIONS ON CIRCUITS AND SYSTEMS I-REGULAR PAPERS*, Volume: 66, Issue: 4, Pages: 1643-1656, ISSN: 1549-8328, eISSN: 1558-0806, 2019;
32. Boran, S., Tamas, A., Mosoarca, G. SOYBEAN BIOESTER OBTAINED IN A BUBBLE COLUMN ESTERIFICATION REACTOR - A RHEOLOGICAL STUDY, *STUDIA UNIVERSITATIS BABES-BOLYAI CHEMIA*, Volume: 64, Issue: 4, Pages: 31-36, ISSN: 1224-7154, 2019;
33. Bordeasu, I., Salcianu, C.L., Popoviciu, M.O., Mitelea, I. Cavitation Erosion Resistance of Laser Beam Nitride Layers of X5CrNi18-10 Stainless Steel, *REVISTA DE CHIMIE*, Volume: 70, Issue: 2, Pages: 708-713, ISSN: 0034-7752, 2019;
34. Botoc, C., Mihancea, E., Molcut, A. Football and Stock Market Performance Correlation: Evidence from Italy, *SCIENTIFIC ANNALS OF ECONOMICS AND BUSINESS*, Volume: 66, Issue: 4, Pages: 525-539, ISSN: 2501-1960, eISSN: 2501-3165, 2019;
35. Bratu, D.C., Vinatu, V.F., Pop, S.I., Petrescu, P.H., Simon, C.P., Popa, G. Wear Resistance Under High Load Forces of Four Different Polyethylene Terephthalate Glycol Vacuum-Formed Orthodontic Retainers, *MATERIALE PLASTICE*, Volume: 56, Issue: 3, Pages: 505-509, ISSN: 0025-5289, 2019;

36. Bucur, F., Putan, V., Socalici, A., Josan, A. RESEARCH ON THE INFLUENCE OF CHEMICAL COMPOSITION ON THE HARDNESS OF CAST IRON, UNIVERSITY POLITEHNICA OF BUCHAREST SCIENTIFIC BULLETIN SERIES B-CHEMISTRY AND MATERIALS SCIENCE, Volume: 81, Issue: 3, Pages: 149-156, ISSN: 1454-2331, 2019;
37. Buse, C., O'Regan, D. A weak integral condition and its connections with existence and uniqueness of solutions for some abstract Cauchy problems in Banach spaces, MONATSHEFTE FÜR MATHEMATIK, Volume: 192, Issue: 3, Pages: 493-512, ISSN: 0026-9255, eISSN: 1436-5081, 2019;
38. Buse, C., Diagana, T., Nguyen, L.T., O'Regan, D. EXPONENTIAL STABILITY FOR SOLUTIONS OF CONTINUOUS AND DISCRETE ABSTRACT CAUCHY PROBLEMS IN BANACH SPACES, ELECTRONIC JOURNAL OF DIFFERENTIAL EQUATIONS, Article Number: 78, ISSN: 1072-6691, 2019;
39. Buse, C., O'Regan, D., Sailerli, O. Hyers-Ulam Stability for Linear Differences with Time Dependent and Periodic Coefficients, SYMMETRY-BASEL, Volume: 11, Issue: 4, Article Number: 512, eISSN: 2073-8994, 2019;
40. Buse, C., O'Regan, D., Sailerli, O. A surjection problem leading to the Ax-Grothendieck theorem, APPLICABLE ANALYSIS, Volume: 98, Issue: 4, Pages: 843-850, ISSN: 0003-6811, eISSN: 1563-504X, 2019;
41. Buse, C., O'Regan, D., Sailerli, O. Hyers-Ulam Stability for Linear Differences with Time Dependent and Periodic Coefficients: The Case When the Monodromy Matrix Has Simple Eigenvalues, SYMMETRY-BASEL, Volume: 11, Issue: 3, Article Number: 339, ISSN: 2073-8994, 2019;
42. Buse, C., O'Regan, D., Sailerli, O. A SURJECTIVITY PROBLEM FOR 3 BY 3 MATRICES, OPERATORS AND MATRICES, Volume: 13, Issue: 1, Pages: 111-119, ISSN: 1846-3886, 2019;
43. Butu, M., Apostol, C., Bud, F., Tache, A., Marcu, D.F., Jeflea, V.F., Stancel, C.D., Duma, S.T. STREAMLINING TECHNOLOGIES FOR PROCESSING SCRAPS FROM ALUMINIUM ALLOYS, UNIVERSITY POLITEHNICA OF BUCHAREST SCIENTIFIC BULLETIN SERIES B-CHEMISTRY AND MATERIALS SCIENCE, Volume: 81, Issue: 4, Pages: 237-252, ISSN: 1454-2331, 2019;
44. Caiman, D.V., Dragomir, T.L. Empirical Voltage-current Signatures for Individual Household Consumers Obtained by Non-linear Regression, STUDIES IN INFORMATICS AND CONTROL, Volume: 28, Issue: 2, Pages: 201-212, ISSN: 1220-1766, 2019;
45. Calinoiu, D.G., Trif-Tordai, G., Ionel, I. IMPACT OF ATMOSPHERIC AEROSOL ON PHOTOVOLTAIC ENERGY PRODUCTION IN ROMANIA, JOURNAL OF ENVIRONMENTAL PROTECTION AND ECOLOGY, Volume: 20, Issue: 3, Pages: 1083-1093, ISSN: 1311-5065, 2019;
46. Capota, E.A., Stangaciu, C.S., Micea, M.V., Curiac, D.I. Towards mixed criticality task scheduling in cyber physical systems: Challenges and perspectives, JOURNAL OF SYSTEMS AND SOFTWARE, Volume: 156, Pages: 204-216, ISSN: 0164-1212, eISSN: 1873-1228, 2019;
47. Caruntu, B., Bota, C., Lapadat, M., Pasca, M.S. Polynomial Least Squares Method for Fractional Lane-Emden Equations, SYMMETRY-BASEL, Volume: 11, Issue: 4, Article Number: 479, eISSN: 2073-8994, 2019;
48. Chieffo, N., Clementi, F., Formisano, A., Lenci, S. Comparative fragility methods for seismic assessment of masonry buildings located in Muccia (Italy), JOURNAL OF BUILDING ENGINEERING, Volume: 25, Article Number: UNSP 100813, ISSN: 2352-7102, 2019;
49. Chieffo, N., Formisano, A. Geo-Hazard-Based Approach for the Estimation of Seismic Vulnerability and Damage Scenarios of the Old City of Senerchia (Avellino, Italy), GEOSCIENCES, Volume: 9, Issue: 2, Article Number: UNSP 59, ISSN: 2076-3263, 2019;
50. Chieffo, N., Formisano, A. The Influence of Geo-Hazard Effects on the Physical Vulnerability Assessment of the Built Heritage: An Application in a District of Naples, BUILDINGS, Volume: 9, Issue: 1, Article Number: 26, ISSN: 2075-5309, 2019;
51. Chieffo, N., Formisano, A., Ferreira, T.M. Damage scenario-based approach and retrofitting strategies for seismic risk mitigation: an application to the historical Centre of Sant'Antimo (Italy), EUROPEAN JOURNAL OF ENVIRONMENTAL AND CIVIL ENGINEERING, Pages: 1-20, ISSN: 1964-8189, eISSN: 2116-7214, 2019;
52. Cioca, L.I., Ivascu, L., Turi, A., Artene, A., Gaman, G.A. Sustainable Development Model for the Automotive Industry, SUSTAINABILITY, Volume: 11, Issue: 22, Article Number: 6447, eISSN: 2071-1050, 2019;
53. Cioca, L.I., Ivascu, L., Szekeley, S. Challenges and opportunities associated with waste recycling development in Romania, QUALITY-ACCESS TO SUCCESS Volume: 20 Pages: 223-228, Supplement: 1, ISSN: 1582-2559, 2019;
54. Ciolea, D.I., Ionel, I., Mihaiuti, A. Research Concerning the Possibility of Turning Sterile Soil Into a Fruitful One, by Using Sludge, REVISTA DE CHIMIE, Volume: 70, Issue: 9, Pages: 3236-3241, ISSN: 0034-7752, 2019;

55. Ciopec, M., Negrea, A., Duteanu, N., Davidescu, C.M., Hulka, I., Motoc, M., Negrea, P., Grad, O., Vaduva, D.B. As(III) Removal by Dynamic Adsorption onto Amberlite XAD7 Functionalized with Crown Ether and Doped with Fe(III) Ions, *REVISTA DE CHIMIE*, Volume: 70, Issue: 7, Pages: 2330-2334, ISSN: 0034-7752, 2019;
56. Ciopec, M., Davidescu, C.M., Negrea, A., Duteanu, N., Rusu, G., Grad, O., Negrea, P. Amberlite XAD7 resin functionalized with crown ether and Fe(III) used for arsenic removal from water, *PURE AND APPLIED CHEMISTRY*, Volume: 91, Issue: 3, Pages: 375-388, ISSN: 0033-4545, eISSN: 1365-3075, 2019;
57. Cîrjăliu, B., Mocan, A., Boatca, M.E., Draghici, A. A propose approach for continuous improvement using ergonomics and quality management knowledge and methodologies, *QUALITY-ACCESS TO SUCCESS*, Volume: 20, Pages: 135-140, Supplement: 1, ISSN: 1582-2559, 2019;
58. Cismariu, L., Gherhes, V. Artificial Intelligence, between Opportunity and Challenge, *BRAIN-BROAD RESEARCH IN ARTIFICIAL INTELLIGENCE AND NEUROSCIENCE*, Volume: 10, Issue: 4, Pages: 40-55, ISSN: 2067-3957, 2019;
59. Cismas, E.C., Lupa, N. A Nash-Moser approach for the Euler-Arnold equations, *MONATSHEFTE FÜR MATHEMATIK*, Volume: 192, Issue: 2, Pages: 333-353, ISSN: 0026-9255, eISSN: 1436-5081, 2019;
60. Coșeci, L., Lupa, L., Pop, A., Visa, A., Maranescu, B., Popa, A. Photocatalytic Degradation of Congo Red Azo Dye Using Phosphono-Aminoacid-Cd(II) Pendant Groups Grafted on a Polymeric Support, *REVISTA DE CHIMIE*, Volume: 70, Issue: 10, Pages: 3473-3476, ISSN: 0034-7752, 2019;
61. Coșeci, L., Lupa, L., Lazau, R., Voda, R., Pode, R. Zinc recovery from waste zinc ash - A new "green" route for the preparation of Zn-Al layered double hydroxide used for molybdate retention, *JOURNAL OF ALLOYS AND COMPOUNDS*, Volume: 787, Pages: 332-343, ISSN: 0925-8388, eISSN: 1873-4669, 2019;
62. Codrean, C., Cosma, C., Tosa, D., Buzdugan, D., Dume, A.I. Composite Materials Fabricated of Amorphous and Nanocrystalline Metallic Powders, *MATERIALE PLASTICE*, Volume: 56, Issue: 4, Pages: 744-749, ISSN: 0025-5289, 2019;
63. Covaciu, F., Iordan, A.E. DESIGNING AND BUILDING A SERIAL ROBOTIC ARM WITH FOUR DEGREES OF FREEDOM, *ACTA TECHNICA NAPOCENSIS SERIES-APPLIED MATHEMATICS MECHANICS AND ENGINEERING*, Volume: 62, Issue: 2, Pages: 317-322, ISSN: 1221-5872, 2019;
64. Cristea, M., Baul, B., Ledeti, I., Ledeti, A., Vlase, G., Vlase, T., Karolewicz, B., Stefanescu, O., Dragomirescu, A.O., Muresan, C., Cipu, D.S., Velimirovici, D., Stefanescu, M. Preformulation studies for atorvastatin calcium An instrumental approach, *JOURNAL OF THERMAL ANALYSIS AND CALORIMETRY*, Volume: 138, Issue: 4, Pages: 2799-2806, ISSN: 1388-6150, eISSN: 1588-2926, 2019;
65. Daianu, D.M., Mindruta, C. Polynomials of Arithmetically Homogeneous Functions: Stability and Hyperstability, *RESULTS IN MATHEMATICS*, Volume: 74, Issue: 1, Article Number: UNSP 59, ISSN: 1422-6383, eISSN: 1420-9012, 2019;
66. Daianu, D.M. FIXED POINT APPROACH TO THE STABILITY OF GENERALIZED POLYNOMIALS, *FIXED POINT THEORY*, Volume: 20, Issue: 1, Pages: 135-155, ISSN: 1583-5022, eISSN: 2066-9208, 2019;
67. David, I., Orboi, M.D., Simandi, M.D., Chirila, C.A., Megyesi, C.I., Radulescu, L., Draghia, L.P., Lukinich-Gruia, A.T., Muntean, C., Hadaruga, D.I., Hadaruga, N.G. Fatty acid profile of Romanian's common bean (*Phaseolus vulgaris* L.) lipid fractions and their complexation ability by beta-cyclodextrin, *PLOS ONE*, Volume: 14, Issue: 11, Article Number: e0225474, PubMed ID: 31756198, ISSN: 1932-6203, 2019;
68. Davidescu, C.M., Ardelean, R., Popa, A. New polymeric adsorbent materials used for removal of phenolic derivatives from wastewaters, *PURE AND APPLIED CHEMISTRY*, Volume: 91, Issue: 3, Pages: 443-458, ISSN: 0033-4545, eISSN: 1365-3075, 2019;
69. Dawod, N., Florescu, A., Antoniac, I.V., Stoia, D.I., Hancu, V., Biclesanu, F.C. The FEA Study of the Biomechanical Behavior of Canine Reconstructed with Composite Resin, *REVISTA DE CHIMIE*, Volume: 70, Issue: 7, Pages: 2456-2462, ISSN: 0034-7752, 2019;
70. Demonceau, J.F., Ciutina, A. Characterisation of Beam-to-column Steel-concrete Composite Joints Beyond Current Eurocode Provisions, *STRUCTURES*, Volume: 21, Special Issue: SI, Pages: 167-175, ISSN: 2352-0124, 2019;
71. Diudea, M.V., Medeleanu, M., Khalaj, Z., Ashrafi, A.R. Spongy Diamond, *IRANIAN JOURNAL OF MATHEMATICAL CHEMISTRY*, Volume: 10, Issue: 1, Pages: 1-9, ISSN: 2228-6489, eISSN: 2008-9015, 2019;
72. Dolha, S., Negirla, P., Alexa, F., Silea, I. Considerations about the Signal Level Measurement in Wireless Sensor Networks for Node Position Estimation, *SENSORS*, Volume: 19, Issue: 19, Article Number: 4179, PubMed ID: 31561569, eISSN: 1424-8220, 2019;

73. Dragomir, G.M., Todorescu, L.L., Greculescu, A. Teacher Dimensions in Technical Higher Education - A Student Perspective, *REVISTA ROMANEASCA PENTRU EDUCATIE MULTIDIMENSIONALA*, Volume: 11, Issue: 2, Pages: 72-93, ISSN: 2066-7329, eISSN: 2067-9270, 2019;
74. Dragomir, G.M., Todorescu, L.L., Stroe, I.G. The Work & Travel Program - Means of Training and Integrating Youth for Adult Life, *REVISTA ROMANEASCA PENTRU EDUCATIE MULTIDIMENSIONALA*, Volume: 11, Issue: 2, Pages: 94-109, ISSN: 2066-7329, eISSN: 2067-9270, 2019;
75. Dubina, D., Marginean, I., Dinu, F. Impact modelling for progressive collapse assessment of selective rack systems, *THIN-WALLED STRUCTURES*, Volume: 143, Special Issue: SI, Article Number: UNSP 106201, ISSN: 0263-8231, eISSN: 1879-3223, 2019;
76. Duma, V.F. OPTICAL ATTENUATORS WITH RISLEY PRISMS AND DISK CHOPPERS, *PROCEEDINGS OF THE ROMANIAN ACADEMY SERIES A-MATHEMATICS PHYSICS TECHNICAL SCIENCES INFORMATION SCIENCE*, Volume: 20, Issue: 2, Pages: 139-148, ISSN: 1454-9069, 2019;
77. Duma, V.F., Sinescu, C., Bradu, A., Podoleanu, A. Optical Coherence Tomography Investigations and Modeling of the Sintering of Ceramic Crowns, *MATERIALS*, Volume: 12, Issue: 6, Article Number: 947, PubMed ID: 30901879, ISSN: 1996-1944, 2019;
78. Duma, V.F. Laser scanners with oscillatory elements: Design and optimization of 1D and 2D scanning functions, *APPLIED MATHEMATICAL MODELLING*, Volume: 67, Pages: 456-476, ISSN: 0307-904X, eISSN: 1872-8480, 2019;
79. Dumitrel, G.A., Glevitzky, M., Cioabla, A.E., Glevitzky, I., Popa, M. STUDY REGARDING THE EFFECT OF TEMPERATURE ON STREPTOMYCIN DEGRADATION IN DIFFERENT TYPES OF HONEY, *JOURNAL OF ENVIRONMENTAL PROTECTION AND ECOLOGY*, Volume: 20, Issue: 2, Pages: 677-684, ISSN: 1311-5065, 2019;
80. Dumitru, R., Ianculescu, A., Pacurariu, C., Lupa, L., Pop, A., Vasile, B., Surdu, A., Manea, F. BiFeO₃-synthesis, characterization and its photocatalytic activity towards doxorubicin degradation from water, *CERAMICS INTERNATIONAL*, Volume: 45, Issue: 2, Special Issue: SI, Pages: 2789-2802, ISSN: 0272-8842, eISSN: 1873-3956, 2019;
81. Fagadar-Cosma, E., Vlascici, D., Birdeanu, M., Fagadar-Cosma, G. Novel fluorescent pH sensor based on 5-(4-carboxy-phenyl)-10,15,20-tris(phenyl)-porphyrin, *ARABIAN JOURNAL OF CHEMISTRY*, Volume: 12, Issue: 7, Pages: 1587-1594, ISSN: 1878-5352, eISSN: 1878-5379, 2019;
82. Feier, A., Chivu, O.R., Stoica, A. Weldability - Behavior of Welded Reinforcement, *REVISTA DE CHIMIE*, Volume: 70, Issue: 10, Pages: 3469-3472, ISSN: 0034-7752, 2019;
83. Filip, I., Mihet-Popa, L., Vasar, C., Prostean, O., Szeidert, I. Considerations Regarding the Design of a Minimum Variance Control System for an Induction Generator, *ELECTRONICS*, Volume: 8, Issue: 5, Article Number: 532, ISSN: 2079-9292, 2019;
84. Filip, I., Vasar, C., Szeidert, I., Prostean, O. Self-tuning strategy for a minimum variance control system of a highly disturbed process, *EUROPEAN JOURNAL OF CONTROL*, Volume: 46, Pages: 49-62, ISSN: 0947-3580, eISSN: 1435-5671, 2019;
85. Fregue, R.T.T., Wachter, A.R., Ionel, I., Vintila, T., Julean, C., Moisa, S., Ungureanu, C.I., Mihaiuti, A.C. Renewable Energy Production Potential by using from Wastes Generated in a Pigs Farm and Slaughterhouse, *REVISTA DE CHIMIE*, Volume: 70, Issue: 6, Pages: 2058-2061, ISSN: 0034-7752, 2019;
86. Fregue, T.T.R., Ionel, I., Gabche, A.S., Mihaiuti, A.C. Optimization of the Activated Carbon Preparation from Avocado Seeds, using the Response Surface Methodology, *REVISTA DE CHIMIE*, Volume: 70, Issue: 2, Pages: 410-416, ISSN: 0034-7752, 2019;
87. Frigura-Iliasa, F.M., Musuroi, S., Sorandaru, C., Vatau, D. Case Study about the Energy Absorption Capacity of Metal Oxide Varistors with Thermal Coupling, *ENERGIES*, Volume: 12, Issue: 3, Article Number: 536, ISSN: 1996-1073, 2019;
88. Frigura-Iliasa, F.M., Musuroi, S., Sorandaru, C., Vatau, D. New Technical Parameters and Operational Improvements of the Metal Oxide Varistors Manufacturing Process, *PROCESSES*, Volume: 7, Issue: 1, Article Number: 18, ISSN: 2227-9717, 2019;
89. Gal-Nadasan, E.G., Gal-Nadasan, N., Poenaru, D.V., Surducun, D., Popa-Andrei, D., Casiana-Salavat, M., Boruga, M.V., Niculescu, B., Tataru, T. The Impact of Prolonged Sitting Hours on the Correct Standing up Position of Elementary School Students in Developed Rural Area, *MATERIALE PLASTICE*, Volume: 56, Issue: 4, Pages: 831-839, ISSN: 0025-5289, 2019;
90. Gheju, M., Balcu, I. Sustaining the efficiency of the Fe(0)/H₂O system for Cr(VI) removal by MnO₂ amendment, *CHEMOSPHERE*, Volume: 214, Pages: 389-398, PubMed ID: 30268895, ISSN: 0045-6535, eISSN: 1879-1298, 2019;

91. Glevitzky, I., Dumitrel, G.A., Glevitzky, M., Pasca, B., Otrisal, P., Bungau, S., Cioca, G., Pantis, C., Popa, M. Statistical Analysis of the Relationship Between Antioxidant Activity and the Structure of Flavonoid Compounds, *REVISTA DE CHIMIE*, Volume: 70, Issue: 9, Pages: 3103-3107, ISSN: 0034-7752, 2019;
92. Glevitzky, M., Dumitrel, G.A., Glevitzky, I., Popa, M. STUDY ON CONTAMINATION OF SNAIL SOFT TISSUES (*Helix pomatia*) WITH CADMIUM IN SIBIU COUNTY, ROMANIA, *JOURNAL OF ENVIRONMENTAL PROTECTION AND ECOLOGY*, Volume: 20, Issue: 2, Pages: 599-607, ISSN: 1311-5065, 2019;
93. Golban, A., Lupa, L., Cochei, L., Pode, R. Synthesis of MgFe Layered Double Hydroxide from Iron-Containing Acidic Residual Solution and Its Adsorption Performance, *CRYSTALS*, Volume: 9, Issue: 10, Article Number: 514, ISSN: 2073-4352, 2019;
94. Gridan, I.M., Ciorsac, A.A., Isvoran, A. Prediction of ADME-Tox properties and toxicological endpoints of triazole fungicides used for cereals protection, *ADMET AND DMPK*, Volume: 7, Issue: 3, Pages: 161-173, ISSN: 1848-7718, 2019;
95. Groza, B., Murvay, P.S. Identity-Based Key Exchange on In-Vehicle Networks: CAN-FD & FlexRay, *SENSORS*, Volume: 19, Issue: 22, Article Number: 4919, PubMed ID: 31718110, eISSN: 1424-8220, 2019;
96. Groza, B., Murvay, P.S. Efficient Intrusion Detection With Bloom Filtering in Controller Area Networks, *IEEE TRANSACTIONS ON INFORMATION FORENSICS AND SECURITY*, Volume: 14, Issue: 4, Pages: 1037-1051, ISSN: 1556-6013, eISSN: 1556-6021, 2019;
97. Groza, B., Popa, L., Murvay, P.S. TRICKS-Time TRiggered Covert Key Sharing for Controller Area Networks, *IEEE ACCESS*, Volume: 7, Pages: 104294-104307, ISSN: 2169-3536, 2019;
98. Hadaruga, N.G., Bandur, G.N., David, I., Hadaruga, D.I. A review on thermal analyses of cyclodextrins and cyclodextrin complexes, *ENVIRONMENTAL CHEMISTRY LETTERS*, Volume: 17, Issue: 1, Pages: 349-373, ISSN: 1610-3653, eISSN: 1610-3661, 2019;
99. Halbac-Cotoara-Zamfir, R., Keesstra, S., Kalantari, Z. The impact of political, socio-economic and cultural factors on implementing environment friendly techniques for sustainable land management and climate change mitigation in Romania, *SCIENCE OF THE TOTAL ENVIRONMENT*, Volume: 654, Pages: 418-429, PubMed ID: 30447580, ISSN: 0048-9697, eISSN: 1879-1026, 2019;
100. Hedrea, C. The Lie-Trotter integrator in the dynamics of a mechanical system, *JOURNAL OF GEOMETRY AND PHYSICS*, Volume: 145, Article Number: UNSP 103470, ISSN: 0393-0440, eISSN: 1879-1662, 2019;
101. Hedrea, E.L., Precup, R.E., Bojan-Dragos, C.A. Results on Tensor Product-based Model Transformation of Magnetic Levitation Systems, *ACTA POLYTECHNICA HUNGARICA*, Volume: 16, Issue: 9, Special Issue: SI, Pages: 93-111, ISSN: 1785-8860, 2019;
102. Herisanu, N., Marinca, V., Madescu, G. Application of the Optimal Auxiliary Functions Method to a Permanent Magnet Synchronous Generator, *INTERNATIONAL JOURNAL OF NONLINEAR SCIENCES AND NUMERICAL SIMULATION*, Volume: 20, Issue: 3-4, Pages: 399-406, ISSN: 1565-1339, eISSN: 2191-0294, 2019;
103. Herisanu, N., Marinca, V., Madescu, G., Dragan, F. Dynamic Response of a Permanent Magnet Synchronous Generator to a Wind Gust, *ENERGIES*, Volume: 12, Issue: 5, Article Number: 915, ISSN: 1996-1073, 2019;
104. Hradil, P., Fulop, L., Ungureanu, V. Reusability of components from single-storey steel-framed buildings, *STEEL CONSTRUCTION-DESIGN AND RESEARCH*, Volume: 12, Issue: 2, Pages: 91-97, ISSN: 1867-0520, eISSN: 1867-0539, 2019;
105. Ianas, C., Piciorus, M., Nicola, R., Ciopec, M., Negrea, A., Niznansky, D., Len, A., Almasy, L., Putz, A.M. Removal of cadmium from aqueous solutions using inorganic porous nanocomposites, *KOREAN JOURNAL OF CHEMICAL ENGINEERING*, Volume: 36, Issue: 5, Pages: 688-700, ISSN: 0256-1115, eISSN: 1975-7220, 2019;
106. Imane, Z., Ben Hachmi, M.K., Halbac-Cotoara-Zamfir, R. QUANTITATIVE WATER MANAGEMENT IN RABAT, SALE AND TIMISOARA DRINKING WATER SYSTEM, *ENVIRONMENTAL ENGINEERING AND MANAGEMENT JOURNAL*, Volume: 18, Issue: 12, Pages: 2567-2577, ISSN: 1582-9596, eISSN: 1843-3707, 2019;
107. Ionescu, D., Kovaci, M. Properties Prescribing and Control of Direct and Inverse Opal Metamaterials Doped with Spinel, Used for Mems, *ACTA PHYSICA POLONICA A*, Volume: 135, Issue: 4, Pages: 849-851, ISSN: 0587-4246, eISSN: 1898-794X, 2019;
108. Ionica, D.A., Maris, S.A., Dicu, R., Maris, S. Linear Programming Tool for the Optimization of Mixed Biomass Fuel Recipes, *BRAIN-BROAD RESEARCH IN ARTIFICIAL INTELLIGENCE AND NEUROSCIENCE*, Volume: 10, Issue: 3, Pages: 145-155, ISSN: 2067-3957, 2019;

109. Iordan, A.E., Covaciu, F. EFFICIENT METHOD TO SOLVE THE GUARINI PUZZLE GENERALIZATION USING BIPARTITE GRAPHS, ACTA TECHNICA NAPOCENSIS SERIES-APPLIED MATHEMATICS MECHANICS AND ENGINEERING, Volume: 62, Issue: 1, Pages: 157-162, ISSN: 1221-5872, 2019;
110. Irekti, A., Oualit, M., Siahmed, H., Buncianu, D., Zibouche, F. EFFECT OF BLACK LIQUOR FROM DATE PALM ON THE WORKABILITY AND COMPRESSIVE STRENGTH OF PORTLAND CEMENT AND CONCRETE, ADVANCES IN MATERIALS SCIENCE, Volume: 19, Issue: 3, Pages: 5-18, ISSN: 2083-4799, 2019;
111. Islam, F., Bhattacharya, B., Popescu, I. Flood risk assessment due to cyclone-induced dike breaching in coastal areas of Bangladesh, NATURAL HAZARDS AND EARTH SYSTEM SCIENCES, Volume: 19, Issue: 2, Pages: 353-368, ISSN: 1561-8633, 2019;
112. Istratie, R., Stoia, M., Pacurariu, C., Locovei, C. Single and simultaneous adsorption of methyl orange and phenol onto magnetic iron oxide/carbon nanocomposites, ARABIAN JOURNAL OF CHEMISTRY, Volume: 12, Issue: 8, Pages: 3704-3722, ISSN: 1878-5352, eISSN: 1878-5379, 2019;
113. Iures, L., Bob, C., Chendes, R., Badea, C., Popa, R. THEORETICAL CONSIDERATIONS AND LAB DETERMINATIONS REGARDING CONCRETE SHRINKAGE, REVISTA ROMANA DE MATERIALE-ROMANIAN JOURNAL OF MATERIALS, Volume: 49, Issue: 2, Pages: 274-278, ISSN: 1583-3186, 2019;
114. Ivascu, L., Cioca, L.I. Occupational Accidents Assessment by Field of Activity and Investigation Model for Prevention and Control, SAFETY, Volume: 5, Issue: 1, Article Number: 12, ISSN: 2313-576X, 2019;
115. Kang, S.H., Tiwari, A.K., Albulescu, C.T., Yoon, S.M. Exploring the time-frequency connectedness and network among crude oil and agriculture commodities V1, ENERGY ECONOMICS, Volume: 84, Article Number: UNSP 104543, ISSN: 0140-9883, eISSN: 1873-6181, 2019;
116. Kang, S.H., Tiwari, A.K., Albulescu, C.T., Yoon, S.M. Time-frequency co-movements between the largest nonferrous metal futures markets, RESOURCES POLICY, Volume: 61, Pages: 393-398, ISSN: 0301-4207, eISSN: 1873-7641, 2019;
117. Kiss, I. CAST IRON ROLLS - AN OVERVIEW ON THE PROPER HARDNESS ASSURED BY THE MANUFACTURING PROCESS, TEHNICKI GLASNIK-TECHNICAL JOURNAL, Volume: 13, Issue: 2, Pages: 92-99, ISSN: 1846-6168, eISSN: 1848-5588, 2019;
118. Lelea, D., Cioabla, A.E. THE NEPCM MATERIAL AS COOLING SOLUTIONS FOR HIGH POWER LIGHT EMITTING DIODES (LED), INGINERIA AUTOMOBILULUI, Issue: 51, Pages: 13-15, ISSN: 1842-4074, 2019;
119. Lemle, L.D. On the L-infinity-Uniqueness of Dynamical Systems with Small Random Perturbation, RESULTS IN MATHEMATICS, Volume: 74, Issue: 1, Article Number: UNSP 26, ISSN: 1422-6383, eISSN: 1420-9012, 2019;
120. Linul, E., Lell, D., Movahedi, N., Codrean, C., Fiedler, T. Compressive properties of zinc syntactic foams at elevated temperatures, COMPOSITES PART B-ENGINEERING, Volume: 167, Pages: 122-134, ISSN: 1359-8368, eISSN: 1879-1069, 2019;
121. Linul, E., Marsavina, L., Linul, P.A., Kovacic, J. Cryogenic and high temperature compressive properties of Metal Foam Matrix Composites, COMPOSITE STRUCTURES, Volume: 209, Pages: 490-498, ISSN: 0263-8223, eISSN: 1879-1085, 2019;
122. Luca, R.E., Todea, C.D., Duma, V.F., Bradu, A., Podoleanu, A.G. Quantitative assessment of rat bone regeneration using complex master-slave optical coherence tomography, QUANTITATIVE IMAGING IN MEDICINE AND SURGERY, Volume: 9, Issue: 5, Special Issue: SI, Pages: 782-798, PubMed ID: 31281774, ISSN: 2223-4292, eISSN: 2223-4306, 2019;
123. Luminosu, I., De Sabata, A., Toader, D., Margineanu, D., Ilie, S. CONCEPTION OF A MASTER DEGREE PROGRAM IN SOLAR ENERGY: INFRASTRUCTURE, STRUCTURE AND RESULTS, ENVIRONMENTAL ENGINEERING AND MANAGEMENT JOURNAL, Volume: 18, Issue: 2, Pages: 291-300, ISSN: 1582-9596, eISSN: 1843-3707, 2019;
124. Lupa, N., Popescu, L.H. Admissible Banach function spaces for linear dynamics with nonuniform behavior on the half-line, SEMIGROUP FORUM, Volume: 98, Issue: 1, Pages: 184-208, ISSN: 0037-1912, eISSN: 1432-2137, 2019;
125. Maranescu, B., Lupa, L., Visa, A. Synthesis, characterization and rare earth elements adsorption properties of phosphonate metal organic frameworks, APPLIED SURFACE SCIENCE, Volume: 481, Pages: 83-91, ISSN: 0169-4332, eISSN: 1873-5584, 2019;
126. Marsavina, L., Iacoviello, F., Pirvulescu, L.D., Di Cocco, V., Rusu, L. Engineering prediction of fatigue strength for AM50 magnesium alloys, INTERNATIONAL JOURNAL OF FATIGUE, Volume: 127, Pages: 10-15, ISSN: 0142-1123, eISSN: 1879-3452, 2019;

127. Marsavina, L., Pop, I.O., Linul, E. Mechanical and fracture properties of particleboard, *FRATTURA ED INTEGRITÀ STRUTTURALE*, Issue: 47, Pages: 266-276, ISSN: 1971-8993, 2019;
128. Matekovits, L., de Sabata, A., Silaghi, A.M. Frequency Selective Surface With Two Quasi-Independent Notch Frequencies, *IEEE ACCESS*, Volume: 7, Pages: 77261-77267, ISSN: 2169-3536, 2019;
129. Mercioni, M.A., Tiron, A., Holban, S. Dynamic Modification of Activation Function using the Backpropagation Algorithm in the Artificial Neural Networks, *INTERNATIONAL JOURNAL OF ADVANCED COMPUTER SCIENCE AND APPLICATIONS*, Volume: 10, Issue: 4, Pages: 51-56, ISSN: 2158-107X, eISSN: 2156-5570, 2019;
130. Miclau, M., Kumar, S., Ursu, D., Orha, C., Miclau, N., Rueff, J.M., Malo, S., Martin, C. Ag₂CrO₄ for photocatalytic applications: High performance of crystals designed by autogenous pressure, *MATERIALS CHARACTERIZATION*, Volume: 158, Article Number: 109970, ISSN: 1044-5803, eISSN: 1873-4189, 2019;
131. Mihailescu, M., Negrea, A., Ciopec, M., Davidescu, C.M., Negrea, P., Duteanu, N., Rusu, G. Gold (III) adsorption from dilute waste solutions onto Amberlite XAD7 resin modified with L-glutamic acid, *SCIENTIFIC REPORTS*, Volume: 9, Article Number: 8757, PubMed ID: 31217435, ISSN: 2045-2322, 2019;
132. Mihailescu, M., Negrea, P., Duteanu, N., Negrea, A., Ciopec, M., Gherman, V., Buzatu, R., Motoc, M. From the Complex Process of Gold Ions Recovery in New Antimicrobial Product, *REVISTA DE CHIMIE*, Volume: 70, Issue: 3, Pages: 1080-1084, ISSN: 0034-7752, 2019;
133. Milici, C., Machado, J.T., Draganescu, G. On the fractional Cornu spirals, *COMMUNICATIONS IN NONLINEAR SCIENCE AND NUMERICAL SIMULATION*, Volume: 67, Pages: 100-107, ISSN: 1007-5704, eISSN: 1878-7274, 2019;
134. Militaru, B.A., Vancea, C., Pode, R. Glass Fertilizers Obtained Using Sewage Sludge ASH Wastes, *REVISTA DE CHIMIE*, Volume: 70, Issue: 11, Pages: 3824-3829, ISSN: 0034-7752, 2019;
135. Militaru, B.A., Pode, R., Manea, F., Linul, P.A. Simple and Combined Acidic Extraction of Phosphorus from Sewage Sludge Ash, *REVISTA DE CHIMIE*, Volume: 70, Issue: 1, Pages: 133-139, ISSN: 0034-7752, 2019;
136. Minzatu, V., Davidescu, C.M., Ciopec, M., Negrea, P., Duteanu, N., Negrea, A., Motoc, M., Manea, A. Eco-materials for Arsenium and Selenium Removal from Aqueous Solutions, *REVISTA DE CHIMIE*, Volume: 70, Issue: 5, Pages: 1586-1591, ISSN: 0034-7752, 2019;
137. Minzatu, V., Davidescu, C.M., Negrea, P., Ciopec, M., Muntean, C., Hulka, I., Paul, C., Negrea, A., Duteanu, N. Synthesis, Characterization and Adsorptive Performances of a Composite Material Based on Carbon and Iron Oxide Particles, *INTERNATIONAL JOURNAL OF MOLECULAR SCIENCES*, Volume: 20, Issue: 7, Article Number: 1609, PubMed ID: 30935127, ISSN: 1422-0067, 2019;
138. Minzatu, V., Davidescu, C.M., Negrea, A., Ciopec, M., Negrea, P., Duteanu, N., Motoc, M., Velimirovici, D. Biopolymers - Carbon Sources for Composite Materials Used as Adsorbents for As (V), *MATERIALE PLASTICE*, Volume: 56, Issue: 1, Pages: 210-215, ISSN: 0025-5289, 2019;
139. Minzatu, V., Davidescu, C.M., Negrea, A., Negrea, P., Ciopec, M., Vancea, C. CELLULAR GLASS AS INERTIZATION ALTERNATIVE FOR THE EXHAUSTED COMPOSITE ADSORPTION MATERIAL RESULTED FROM THE REMOVAL OF ARSENIC FROM WASTE WATERS, *REVISTA ROMANA DE MATERIALE-ROMANIAN JOURNAL OF MATERIALS*, Volume: 49, Issue: 2, Pages: 193-200, ISSN: 1583-3186, 2019;
140. Mitelea, I., Bena, T., Bordeasu, I., Utu, I.D., Craciunescu, C.M. Enhancement of Cavitation Erosion Resistance of Cast Iron with TIG Remelted Surface, *METALLURGICAL AND MATERIALS TRANSACTIONS A-PHYSICAL METALLURGY AND MATERIALS SCIENCE*, Volume: 50A, Issue: 8, Pages: 3767-3775, ISSN: 1073-5623, eISSN: 1543-1940, 2019;
141. Mitelea, I., Utu, I.D., Karancsi, O., Urgan, S.D., Marius, C. Investigation of the microstructure of dissimilar welds in duplex stainless steel and low alloyed steel, *MATERIALS TESTING*, Volume: 61, Issue: 2, Pages: 120-124, ISSN: 0025-5300, 2019;
142. Moaca, E.A., Farcas, C., Coricovact, D., Avram, S., Mihali, C.V., Draghici, G.A., Loghin, F., Pacurariu, C., Dehelean, C. Oleic Acid Double Coated Fe₃O₄ Nanoparticles as Anti-Melanoma Compounds with a Complex Mechanism of Activity-In Vitro and In Ovo Assessment, *JOURNAL OF BIOMEDICAL NANOTECHNOLOGY*, Volume: 15, Issue: 5, Pages: 893-909, PubMed ID: 30890222, ISSN: 1550-7033, eISSN: 1550-7041, 2019;
143. Moaca, E.A., Mihali, C.V., Macasoi, I.G., Racoviceanu, R., Soica, C., Dehelean, C.A., Pacurariu, C., Florescu, S. Fe₃O₄@C Matrix with Tailorable Adsorption Capacities for Paracetamol and Acetylsalicylic Acid: Synthesis, Characterization, and Kinetic Modeling, *MOLECULES*, Volume: 24, Issue: 9, PubMed ID: 31058855, eISSN: 1420-3049, 2019;

144. Mos, D.C., Muntean, S., Anton, L.E. 3D numerical flow analysis of the non-uniformity induced by a reshaped geometry of the symmetrical suction elbow, *WASSERWIRTSCHAFT*, Volume: 109, Special Issue: 1, Pages: 77-82, ISSN: 0043-0978, eISSN: 2192-8762, 2019;
145. Moscovici, A.M., Vilceanu, C.B., Grecea, C., Herban, S. SPATIAL DATA GEOPORTAL FOR LOCAL ADMINISTRATION - SOLUTION FOR SMART CITIES, *JOURNAL OF ENVIRONMENTAL PROTECTION AND ECOLOGY*, Volume: 20, Issue: 3, Pages: 1374-1383, ISSN: 1311-5065, 2019;
146. Moscovici, A.M., Paunescu, V., Salagean, T., Calin, M., Iliescu, A., Suba, E., Grecea, C., Manea, R. 3D CADASTRE: A SMART APPROACH FOR ROAD INFRASTRUCTURE, *AGROLIFE SCIENTIFIC JOURNAL*, Volume: 8, Issue: 1, Pages: 192-197, ISSN: 2285-5718, eISSN: 2286-0126, 2019;
147. Mosoarca, M., Onescu, I., Onescu, E., Azap, B., Chieffo, N., Szitar-Sirbu, M. Seismic vulnerability assessment for the historical areas of the Timisoara city, Romania, *ENGINEERING FAILURE ANALYSIS*, Volume: 101, Pages: 86-112, ISSN: 1350-6307, eISSN: 1873-1961, 2019;
148. Mosoarca, M., Keller, A.I., Bocan, C. Failure analysis of church towers and roof structures due to high wind velocities, *ENGINEERING FAILURE ANALYSIS*, Volume: 100, Pages: 76-87, ISSN: 1350-6307, eISSN: 1873-1961, 2019;
149. Mosoiu, C., Vlase, D., Vlase, G., Lazau, R., Vlase, T. TG-DTA and FTIR analyses of roman and later historic mortars from Drobeta-Turnu Severin region, *JOURNAL OF THERMAL ANALYSIS AND CALORIMETRY*, Volume: 138, Issue: 3, Pages: 2159-2166, ISSN: 1388-6150, eISSN: 1588-2926, 2019;
150. Motoc, S., Cretu, C., Costisor, O., Baci, A., Manea, F., Szerb, E.I. Cu(II) Coordination Complex Precursor for Randomized CuO_x Microarray Loaded on Carbon Nanofiber with Excellent Electrocatalytic Performance for Electrochemical Glucose Detection, *SENSORS*, Volume: 19, Issue: 24, Article Number: 5353, PubMed ID: 31817245, eISSN: 1424-8220, 2019;
151. Motoc, S., Manea, F., Orha, C., Pop, A. Enhanced Electrochemical Response of Diclofenac at a Fullerene-Carbon Nanofiber Paste Electrode, *SENSORS*, Volume: 19, Issue: 6, Article Number: 1332, PubMed ID: 30884875, ISSN: 1424-8220, 2019;
152. Muntean, S., Marsavina, L., Hedes, A., Anton, L.E., Vlaicu, I. In situ investigations and failure analysis of the rainwater pumps installed in a wastewater treatment plant, *WASSERWIRTSCHAFT*, Volume: 109, Special Issue: 1, Pages: 42-47, ISSN: 0043-0978, eISSN: 2192-8762, 2019;
153. Muntean, S.G., Nistor, M.A., Ianos, R., Pacurariu, C., Capraru, A., Surdu, V.A. Combustion synthesis of Fe₃O₄/Ag/C nanocomposite and application for dyes removal from multicomponent systems, *APPLIED SURFACE SCIENCE*, Volume: 481, Pages: 825-837, ISSN: 0169-4332, eISSN: 1873-5584, 2019;
154. Nagy, R., Maruta, R.S., Hluscu, M., Menyhardt, K. Mechanical Assessment of Fuel Line Hoses under Variable Pressure, *MATERIALE PLASTICE*, Volume: 56, Issue: 2, Pages: 466-468, ISSN: 0025-5289, 2019;
155. Nedelcu, D., Cojocaru, V., Micu, L.M., Florea, D., Hluscu, M. Using of Polymers for Rapid Prototyping of an Axial Microturbine Runner and Wicked Gates, *MATERIALE PLASTICE*, Volume: 56, Issue: 2, Pages: 454-459, ISSN: 0025-5289, 2019;
156. Nichita, I., Lupa, L., Stoia, M., Dragan, E.S., Popa, A. Aminophosphonic groups grafted onto the structure of macroporous styrene-divinylbenzene copolymer: preparation and studies on the antimicrobial effect, *POLYMER BULLETIN*, Volume: 76, Issue: 9, Pages: 4539-4557, ISSN: 0170-0839, eISSN: 1436-2449, 2019;
157. Nicola, R., Costisor, O., Muntean, S.G., Nistor, M.A., Putz, A.M., Ianasi, C., Lazau, R., Almasy, L., Sacarescu, L. Mesoporous magnetic nanocomposites: a promising adsorbent for the removal of dyes from aqueous solutions, *JOURNAL OF POROUS MATERIALS*, Volume: 27, Issue: 2, Pages: 413-428, ISSN: 1380-2224, eISSN: 1573-4854, 2019;
158. Nicolae, A., Korodi, A., Silea, I. Identifying Data Dependencies as First Step to Obtain a Proactive Historian: Test Scenario in the Water Industry 4.0, *WATER*, Volume: 11, Issue: 6, ISSN: 2073-4441, 2019;
159. Nicolae, A., Korodi, A., Silea, I. An Overview of Industry 4.0 Development Directions in the Industrial Internet of Things Context, *ROMANIAN JOURNAL OF INFORMATION SCIENCE AND TECHNOLOGY*, Volume: 22, Issue: 3-4, Pages: 183-201, ISSN: 1453-8245, 2019;
160. Nita, L., Grozav, A., Rogobete, G. Natural and Anthropogenic Soil Acidification in the West of Romania, *REVISTA DE CHIMIE*, Volume: 70, Issue: 6, Pages: 2237-2240, ISSN: 0034-7752, 2019;
161. Nitu, S., Padure, M., Tamas, A., Rusnac, L.M. COMPARATIVE ANALYSIS OF WALNUTS AND PEANUTS OILS, *STUDIA UNIVERSITATIS BABES-BOLYAI CHEMIA*, Volume: 64, Issue: 3, Pages: 229-237, ISSN: 1224-7154, 2019;
162. Opris, C., Codrean, C., Buzdugan, D., Hididis, P. Copper Based Bulk Metallic Glasses for Medical Devices, *MATERIALE PLASTICE*, Volume: 56, Issue: 4, Pages: 700-704, ISSN: 0025-5289, 2019;

163. Pana, A., Baloi, A., Molnar-Matel, F. Data from numerical analysis, simulation and experimental determinations performed to verify the sizing of an unbalanced capacitive compensator for three-phase four-wires networks, *DATA IN BRIEF*, Volume: 25, Article Number: UNSP 104366, PubMed ID: 31485471, ISSN: 2352-3409, 2019;
164. Pana, A., Baloi, A., Molnar-Matei, F. Mathematical Explanations of a Paradox Observed in a HVAC (High Voltage Alternating Current) Untransposed Overhead Line, *ENERGIES*, Volume: 12, Issue: 4, Article Number: 734, ISSN: 1996-1073, 2019;
165. Pana, A.M., Dumitrel, G.A., Ordodi, L.V., Gherman, V., Rusu, G., Stanescu, A., Rusnac, L.M. PRELIMINARY STUDY ON POLYMER DEGRADATION USING AN AEROBIC REACTOR, *JOURNAL OF ENVIRONMENTAL PROTECTION AND ECOLOGY*, Volume: 20, Issue: 4, Pages: 1951-1959, ISSN: 1311-5065, 2019;
166. Pana, A.M., Gherman, V., Sfirloaga, P., Rusu, G., Bandur, G., Popa, M., Rusnac, L.M., Dumitrel, G.A. Biodegradation studies on new glycopolymers derived from oligomeric D-mannose itaconates and 2-hydroxypropyl acrylate, *POLYMER DEGRADATION AND STABILITY*, Volume: 167, Pages: 210-216, ISSN: 0141-3910, eISSN: 1873-2321, 2019;
167. Panteli, S., Savva, I., Efstathiou, M., Vekas, L., Marinica, O.M., Krasia-Christoforou, T., Pashalidis, I. beta-ketoester-functionalized magnetoactive electrospun polymer fibers as Eu(III) adsorbents, *SN APPLIED SCIENCES*, Volume: 1, Issue: 1, Article Number: 30, ISSN: 2523-3963, eISSN: 2523-3971, 2019;
168. Patrinoiu, G., Dumitru, R., Culita, D.C., Munteanu, C., Birjega, R., Calderon-Moreno, J.M., Cucos, A., Pelinescu, D., Chifriuc, M.C., Bleotu, C., Carp, O. Self-assembled zinc oxide hierarchical structures with enhanced antibacterial properties from stacked chain-like zinc oxalate compounds, *JOURNAL OF COLLOID AND INTERFACE SCIENCE*, Volume: 552, Pages: 258-270, PubMed ID: 31129297, ISSN: 0021-9797, eISSN: 1095-7103, 2019;
169. Pausescu, I., Todea, A., Badea, V., Peter, F., Medeleanu, M., Ledeti, I., Vlase, G., Vlase, T. Optical and thermal properties of intelligent pH indicator films based on chitosan/PVA and a new xanthylum dye, *JOURNAL OF THERMAL ANALYSIS AND CALORIMETRY*, Volume: 141, Issue: 3, Pages: 999-1008, ISSN: 1388-6150, eISSN: 1588-2926, 2019;
170. Petrosanu, D.M., Carutasu, G., Carutasu, N.L., Pirjan, A. A Review of the Recent Developments in Integrating Machine Learning Models with Sensor Devices in the Smart Buildings Sector with a View to Attaining Enhanced Sensing, Energy Efficiency, and Optimal Building Management, *ENERGIES*, Volume: 12, Issue: 24, Article Number: 4745, eISSN: 1996-1073, 2019;
171. Peyghami, S., Davari, P., Fotuhi-Firuzabad, M., Blaabjerg, F. Standard Test Systems for Modern Power System Analysis An Overview, *IEEE INDUSTRIAL ELECTRONICS MAGAZINE*, Volume: 13, Issue: 4, Pages: 86-105, ISSN: 1932-4529, eISSN: 1941-0115, 2019;
172. Pinca-Bretotean, C., Lemle, L.D., Szabo, A. Ecological Composites Materials for Brake Pads Using Shells as Filler Material, *MATERIALE PLASTICE*, Volume: 56, Issue: 3, Pages: 588-591, ISSN: 0025-5289, 2019;
173. Poletti, E., Vasconcelos, G., Branco, J.M., Isopescu, B. Effects of extreme environmental exposure conditions on the mechanical behaviour of traditional carpentry joints, *CONSTRUCTION AND BUILDING MATERIALS*, Volume: 213, Pages: 61-78, ISSN: 0950-0618, eISSN: 1879-0526, 2019;
174. Pop, C., Ene, R.D. Stability Problems and Analytical Integration for the Clebsch's System, *OPEN MATHEMATICS*, Volume: 17, Pages: 242-259, ISSN: 2391-5455, 2019;
175. Pop-Calimanu, I.M., Lica, S., Popescu, S., Lascu, D., Lie, I., Mirsu, R. A New Hybrid Inductor-Based Boost DC-DC Converter Suitable for Applications in Photovoltaic Systems, *ENERGIES*, Volume: 12, Issue: 2, Article Number: 252, ISSN: 1996-1073, 2019;
176. Popa, A., Faur, N., Hluscu, M., Belin, C. Evaluation of the Mechanical Properties of the Samples Made by FDM 3D Printing, *MATERIALE PLASTICE*, Volume: 56, Issue: 3, Pages: 500-504, ISSN: 0025-5289, 2019;
177. Popa, D.M. ENGINEERING RISK OF SERIES PRODUCTION IN AUTOMOTIVE INDUSTRY, *MANAGEMENT SYSTEMS IN PRODUCTION ENGINEERING*, Volume: 27, Issue: 1, Pages: 5-11, ISSN: 2299-0461, eISSN: 2450-5781, 2019;
178. Popa, G., Bratu, D.C., Bortun, M.C., Vinatu, V.F., Both, I., Simon, C.P., Pop, S.I., Podariu, A.C. Tensile and Shear Breaking Force of the Joints Between Stainless-Steel Orthodontic Bands and Buccal Tube Attachments Joined by Laser and TIG Welding Without Filler Material, *MATERIALE PLASTICE*, Volume: 56, Issue: 4, Pages: 693-699, ISSN: 0025-5289, 2019;

179. Popa, M., Glevitzky, I., Dumitrel, G.A., Glevitzky, M., Popa, D. IMPACT OF ENVIRONMENTAL FACTORS ON THE QUALITY OF SPRING WATER FROM ABRUD-CAMPENI AREA, ALBA COUNTY, ROMANIA, *AGROLIFE SCIENTIFIC JOURNAL*, Volume: 8, Issue: 1, Pages: 220-226, ISSN: 2285-5718, eISSN: 2286-0126, 2019;
180. Popa, S., Boran, S., Mosoarca, G., Vancea, C. HEAT TRANSFER INFLUENCE ON FRACTIONATION IN FLOODED PACKED COLUMNS, *STUDIA UNIVERSITATIS BABES-BOLYAI CHEMIA*, Volume: 64, Issue: 3, Pages: 143-152, ISSN: 1224-7154, 2019;
181. Radac, M.B., Lala, T. Learning Output Reference Model Tracking for Higher-Order Nonlinear Systems with Unknown Dynamics, *ALGORITHMS*, Volume: 12, Issue: 6, Article Number: 121, ISSN: 1999-4893, 2019;
182. Radac, M.B., Precup, R.E. Data-Driven Model-Free Tracking Reinforcement Learning Control with VRFT-based Adaptive Actor-Critic, *APPLIED SCIENCES-BASEL*, Volume: 9, Issue: 9, Article Number: 1807, eISSN: 2076-3417, 2019;
183. Rajak, D.K., Mahajan, N.N., Linul, E. Crashworthiness performance and microstructural characteristics of foam-filled thin-walled tubes under diverse strain rate, *JOURNAL OF ALLOYS AND COMPOUNDS*, Volume: 775, Pages: 675-689, ISSN: 0925-8388, eISSN: 1873-4669, 2019;
184. Rajak, D.K., Pagar, D.D., Menezes, P.L., Linul, E. Fiber-Reinforced Polymer Composites: Manufacturing, Properties, and Applications, *POLYMERS*, Volume: 11, Issue: 10, Article Number: 1667, PubMed ID: 31614875, eISSN: 2073-4360, 2019;
185. Ratiu, S.A., Zgaverdea, A.C. The Potential of Using Bio Plastic Materials in Automotive Applications, *MATERIALE PLASTICE*, Volume: 56, Issue: 4, Pages: 901-909, ISSN: 0025-5289, 2019;
186. Reisz, E., Tekle-Roettering, A., Naumov, S., Schmidt, W., Schmidt, T.C. Reaction of 1-propanol with Ozone in Aqueous Media, *INTERNATIONAL JOURNAL OF MOLECULAR SCIENCES*, Volume: 20, Issue: 17, PubMed ID: 31454911, eISSN: 1422-0067, 2019;
187. Robu, A., Mironov, V., Neagu, A. Using Sacrificial Cell Spheroids for the Bioprinting of Perfusable 3D Tissue and Organ Constructs: A Computational Study, *COMPUTATIONAL AND MATHEMATICAL METHODS IN MEDICINE*, Article Number: 7853586, PubMed ID: 31236128, ISSN: 1748-670X, eISSN: 1748-6718, 2019;
188. Roman, R.C., Precup, R.E., Petriu, E.M., Dragan, F. Combination of Data-Driven Active Disturbance Rejection and Takagi-Sugeno Fuzzy Control with Experimental Validation on Tower Crane Systems, *ENERGIES*, Volume: 12, Issue: 8, Article Number: 1548, ISSN: 1996-1073, 2019;
189. Sarbu, I., Mirza, M., Crasmareanu, E. A review of modelling and optimisation techniques for district heating systems, *INTERNATIONAL JOURNAL OF ENERGY RESEARCH*, Volume: 43, Issue: 13, Pages: 6572-6598, ISSN: 0363-907X, eISSN: 1099-114X, 2019;
190. Sarbu, I., Dorca, A. Review on heat transfer analysis in thermal energy storage using latent heat storage systems and phase change materials, *INTERNATIONAL JOURNAL OF ENERGY RESEARCH*, Volume: 43, Issue: 1, Pages: 29-64, ISSN: 0363-907X, eISSN: 1099-114X, 2019;
191. Savu, I.D., Savu, S.V., Simion, D., Sirbu, N.A., Ciornei, M., Ratiu, S.A. PP in 3D Printing - Technical and Economic Aspects, *MATERIALE PLASTICE*, Volume: 56, Issue: 4, Pages: 931-936, ISSN: 0025-5289, 2019;
192. Scorza, D., Marsavina, L., Carpinteri, A., Ronchei, C., Vantadori, S. Size-effect independence of particleboard fracture toughness, *COMPOSITE STRUCTURES*, Volume: 229, Article Number: UNSP 111374, ISSN: 0263-8223, eISSN: 1879-1085, 2019;
193. Seclaman, E., Balacescu, L., Balacescu, O., Bejinar, C., Udrescu, M., Marian, C., Sirbu, I.O., Anghel, A. MicroRNAs mediate liver transcriptome changes upon soy diet intervention in mice, *JOURNAL OF CELLULAR AND MOLECULAR MEDICINE*, Volume: 23, Issue: 3, Pages: 2263-2267, PubMed ID: 30618122, eISSN: 1582-4934, 2019;
194. Serafim, V., Chirita-Emandi, A., Andreescu, N., Tiugan, D.A., Tutac, P., Paul, C., Velea, I., Mihailescu, A., Serban, C.L., Zimbru, C.G., Puiu, M., Niculescu, M.D. Single Nucleotide Polymorphisms in PEMT and MTHFR Genes are Associated with Omega 3 and 6 Fatty Acid Levels in the Red Blood Cells of Children with Obesity, *NUTRIENTS*, Volume: 11, Issue: 11, Article Number: 2600, PubMed ID: 31671528, eISSN: 2072-6643, 2019;
195. Serban, D.A., Marsavina, L., Rusu, L., Negru, R. Numerical study of the behavior of magnesium alloy AM50 in tensile and torsional loadings, *ARCHIVE OF APPLIED MECHANICS*, Volume: 89, Issue: 5, Special Issue: SI, Pages: 911-917, ISSN: 0939-1533, eISSN: 1432-0681, 2019;
196. Simo, A., Barbulescu, C., Kilyeni, S., Dragos, C. Manufacturing Process Monitoring in Terms of Energy Management Improving, *INTERNATIONAL JOURNAL OF COMPUTERS COMMUNICATIONS & CONTROL*, Volume: 14, Issue: 3, Pages: 388-400, ISSN: 1841-9836, eISSN: 1841-9844, 2019;

197. Sora, I., Chirila, C.B. Finding key classes in object-oriented software systems by techniques based on static analysis, *INFORMATION AND SOFTWARE TECHNOLOGY*, Volume: 116, Article Number: UNSP 106176, ISSN: 0950-5849, eISSN: 1873-6025, 2019;
198. Sorandaru, C., Musuroi, S., Frigura-Iliasa, F.M., Vatau, D., Dordescu, M. Analysis of the Wind System Operation in the Optimal Energetic Area at Variable Wind Speed over Time, *SUSTAINABILITY*, Volume: 11, Issue: 5, Article Number: 1249, ISSN: 2071-1050, 2019;
199. Stanescu, D., Stratulat, M., Negrea, R., Ghergulescu, I. Cover Processing-based Steganographic Model with Improved Security, *ACTA POLYTECHNICA HUNGARICA*, Volume: 16, Issue: 1, Pages: 227-246, ISSN: 1785-8860, 2019;
200. Stavi, I., Gusarov, Y., Halbac-Cotoara-Zamfir, R. Collapse and failure of ancient agricultural stone terraces: On-site geomorphic processes, pedogenic mechanisms, and soil quality, *GEODERMA*, Volume: 344, Pages: 144-152, ISSN: 0016-7061, eISSN: 1872-6259, 2019;
201. Stefanescu, M., Muntean, C., Berei, E., Vlase, T., Stefanescu, O. Preparation and characterization of CuCr2O4/SiO2 and Cu2Cr2O4/SiO2 nanocomposites obtained from carboxylate complex combinations, *JOURNAL OF THERMAL ANALYSIS AND CALORIMETRY*, Volume: 138, Issue: 3, Pages: 1887-1894, ISSN: 1388-6150, eISSN: 1588-2926, 2019;
202. Stoia, D.I., Marsavina, L., Linul, E. Correlations between Process Parameters and Outcome Properties of Laser-Sintered Polyamide, *POLYMERS*, Volume: 11, Issue: 11, Article Number: 1850, PubMed ID: 31717539, eISSN: 2073-4360, 2019;
203. Stoia, D.I., Linul, E., Marsavina, L. Influence of Manufacturing Parameters on Mechanical Properties of Porous Materials by Selective Laser Sintering, *MATERIALS*, Volume: 12, Issue: 6, Article Number: 871, PubMed ID: 30875894, ISSN: 1996-1944, 2019;
204. Stoia, M., Pacurariu, C., Mihali, C., Malaescu, I., Marin, C.N., Capraru, A. Manganese ferrite-polyaniline hybrid materials: Electrical and magnetic properties, *CERAMICS INTERNATIONAL*, Volume: 45, Issue: 2, Special Issue: SI, Pages: 2725-2735, ISSN: 0272-8842, eISSN: 1873-3956, 2019;
205. Stroita, D.C., Manea, A.S., Cernescu, A. Blade Polymeric Material Study of a Cross-Flow Water Turbine Runner, *MATERIALE PLASTICE*, Volume: 56, Issue: 2, Pages: 366-369, ISSN: 0025-5289, 2019;
206. Szabo, R., Gontean, A. Sun Tracker Robotic Arm Optical Distance Measurement Evaluation at Different Positions Using Six Sigma Tools, *INFOCOMMUNICATIONS JOURNAL*, Volume: 11, Issue: 1, Pages: 54-60, ISSN: 2061-2079, eISSN: 2061-2125, 2019;
207. Tagne, R.F.T., Anagho, S.G., Ionel, I., Matiuti, A.C., Ungureanu, C.I. EXPERIMENTAL BIOGAS PRODUCTION FROM CAMEROON LIGNOCELLULOSIC WASTE BIOMASS, *JOURNAL OF ENVIRONMENTAL PROTECTION AND ECOLOGY*, Volume: 20, Issue: 3, Pages: 1335-1344, ISSN: 1311-5065, 2019;
208. Tamas, A., Nitu, S. Aqueous Solutions of Polyethoxylated Fatty Alcohols Rheological behavior and superficial properties, *REVISTA DE CHIMIE*, Volume: 70, Issue: 2, Pages: 382-386, ISSN: 0034-7752, 2019;
209. Tamas, A., Boran, S. THE RHEOLOGICAL BEHAVIOR OF THE MIXTURES OF CASTOR OIL WITH ADIPIC ESTERS, *STUDIA UNIVERSITATIS BABES-BOLYAI CHEMIA*, Volume: 64, Issue: 1, Pages: 93-102, ISSN: 1224-7154, 2019;
210. Tanasa, C., Bosioc, A., Muntean, S., Susan-Resiga, R. A Novel Passive Method to Control the Swirling Flow with Vortex Rope from the Conical Diffuser of Hydraulic Turbines with Fixed Blades, *APPLIED SCIENCES-BASEL*, Volume: 9, Issue: 22, Article Number: 4910, eISSN: 2076-3417, 2019;
211. Taucean, I.M., Ivascu, L., Miclea, S., Negrut, M. Synergies between lean and sustainability: a literature review of concepts and tools, *QUALITY-ACCESS TO SUCCESS*, Volume: 20, Pages: 559-564, Supplement: 1, ISSN: 1582-2559, 2019;
212. Taucean, I.M., Tamasila, M., Ivascu, L., Miclea, S., Negrut, M. Integrating Sustainability and Lean: SLIM Method and Enterprise Game Proposed, *SUSTAINABILITY*, Volume: 11, Issue: 7, Article Number: 2103, ISSN: 2071-1050, 2019;
213. Tidrea, A., Korodi, A., Silea, I. Cryptographic Considerations for Automation and SCADA Systems Using Trusted Platform Modules, *SENSORS*, Volume: 19, Issue: 19, Article Number: 4191, PubMed ID: 31569636, eISSN: 1424-8220, 2019;
214. Timpea, S.A., Cosma, C., Sosdean, D. Touch Screen Tester Device End-Effector, *MATERIALE PLASTICE*, Volume: 56, Issue: 2, Pages: 445-448, ISSN: 0025-5289, 2019;
215. Tita, I.C., Lupa, L., Tita, B., Stan, R.L., Vicas, L. Compatibility Studies of Valsartan with Different Pharmaceutical Excipients, *REVISTA DE CHIMIE*, Volume: 70, Issue: 7, Pages: 2590-2600, ISSN: 0034-7752, 2019;

216. Todea, A., Bitcan, I., Aparaschivei, D., Pausescu, I., Badea, V., Peter, F., Gherman, V.D., Rusu, G., Nagy, L., Keki, S. Biodegradable Oligoesters of epsilon-Caprolactone and 5-Hydroxymethyl-2-Furancarboxylic Acid Synthesized by Immobilized Lipases, POLYMERS, Volume: 11, Issue: 9, Article Number: 1402, PubMed ID: 31455024, eISSN: 2073-4360, 2019;
217. Toma, P.D., Tokar, A., Toropoc, M.S. Modelling and Simulation Eutrophication of Water Rivers, REVISTA DE CHIMIE, Volume: 70, Issue: 8, Pages: 2912-2916, ISSN: 0034-7752, 2019;
218. Ursu, D., Vajda, M., Miclau, M. Investigation of the p-type dye-sensitized solar cell based on full Cu₂O electrodes, JOURNAL OF ALLOYS AND COMPOUNDS, Volume: 802, Pages: 86-92, ISSN: 0925-8388, eISSN: 1873-4669, 2019;
219. Ursu, D., Vajda, M., Miclau, M. Hydrothermal synthesis of 3D hierarchical flower-like CuGaO₂ with high surface area for dye-sensitized solar cell, MICRO & NANO LETTERS, Volume: 14, Issue: 8, Pages: 872-876, eISSN: 1750-0443, 2019;
220. Utu, I.D., Mitelea, I., Bordeasu, I., Bena, T. Investigations Concerning the Corrosion and Ultrasonic Cavitation Erosion of 316L Coatings Deposited HVOF on Nodular Cast Iron, REVISTA DE CHIMIE, Volume: 70, Issue: 5, Pages: 1625-1631, ISSN: 0034-7752, 2019;
221. Vacheva, G., Hinov, N., Kanchev, H., Stanev, R., Cornea, O. Energy Flows Management of Multiple Electric Vehicles in Smart Grid, ELEKTRONIKA IR ELEKTROTEHNIKA, Volume: 25, Issue: 1, Pages: 14-17, ISSN: 1392-1215, 2019;
222. Valean, P.C., Kazamer, N., Pascal, D.T., Muntean, R., Baranyi, I., Marginean, G., Serban, V.A. Characteristics of Thermally Sprayed NiCrBSi Coatings before and after Electromagnetic Induction Remelting Process, ACTA POLYTECHNICA HUNGARICA, Volume: 16, Issue: 3, Pages: 7-18, ISSN: 1785-8860, 2019;
223. Vares, S., Hradil, P., Sansom, M., Ungureanu, V. Economic potential and environmental impacts of reused steel structures, STRUCTURE AND INFRASTRUCTURE ENGINEERING, Volume: 16, Issue: 4, Special Issue: SI, Pages: 750-761, ISSN: 1573-2479, eISSN: 1744-8980, 2019;
224. Vasilescu, C., Todea, A., Nan, A., Circu, M., Turcu, R., Benea, I.C., Peter, F. Enzymatic synthesis of short-chain flavor esters from natural sources using tailored magnetic biocatalysts, FOOD CHEMISTRY, Volume: 296, Pages: 1-8, PubMed ID: 31202292, ISSN: 0308-8146, eISSN: 1873-7072, 2019;
225. Vasilescu, M.D. Influence of Constructive and Technological Parameters at Generated Spiral Parts with DLP 3D Printing Process, MATERIALE PLASTICE, Volume: 56, Issue: 4, Pages: 801-811, ISSN: 0025-5289, 2019;
226. Vasilescu, M.D. Constructiv and Technological Consideration on the Generation of Gear Made by the DLP 3D-Printed Methode, MATERIALE PLASTICE, Volume: 56, Issue: 2, Pages: 440-444, ISSN: 0025-5289, 2019;
227. Vaszilcsin, N., Duca, D.A., Flueraș, A., Dan, M.L. EXPIRED DRUGS AS INHIBITORS IN ELECTROCHEMICAL PROCESSES - A MINI-REVIEW, STUDIA UNIVERSITATIS BABES-BOLYAI CHEMIA, Volume: 64, Issue: 3, Pages: 17-32, ISSN: 1224-7154, 2019;
228. Venturini, A.B., Assumpcao, T.H., Popescu, I., Jonoski, A., Solomatine, D.P. Modelling support to citizen observatories for strategic Danube Delta planning: Sontea-Fortuna case study, JOURNAL OF ENVIRONMENTAL PLANNING AND MANAGEMENT, Volume: 62, Issue: 11, Pages: 1972-1989, ISSN: 0964-0568, eISSN: 1360-0559, 2019;
229. Vintila, T., Ionel, I., Fregue, T.T.R., Wachter, A.R., Julean, C., Gabche, A.S. Residual Biomass from Food Processing Industry in Cameroon as Feedstock for Second-generation Biofuels, BIORESOURCES, Volume: 14, Issue: 2, Pages: 3731-3745, ISSN: 1930-2126, 2019;
230. Vlase, D., Rogozea, O., Mosoiu, C., Vlase, G., Lazau, R., Vlase, T. Thermoanalytical investigations of some ceramics dated from the Neolithic period, discovered at Oxenbrickel, Sanandrei, Romania, JOURNAL OF THERMAL ANALYSIS AND CALORIMETRY, Volume: 138, Issue: 3, Pages: 2145-2157, ISSN: 1388-6150, eISSN: 1588-2926, 2019;
231. Voda, M., Codrean, C., Chicot, D., Serban, V.A., Utu, D., Linul, E., Buzdugan, D. Characterization of brazed joints by electrical resistance spot brazing with Ni-based amorphous self-flux alloys, JOURNAL OF MANUFACTURING PROCESSES, Volume: 37, Pages: 617-627, ISSN: 1526-6125, 2019;
232. Voda, M., Pertuz-Comas, A., Serban, V.A. Correlation between mass loss on the cavitation erosion and the fatigue stress level for a martensitic stainless steel, UIS INGENIERIAS, Volume: 18, Issue: 1, Pages: 11-19, ISSN: 1657-4583, 2019;
233. Vujic, B.B., Marceta, U.V., Popescu, F., Tot, B.I. AIR QUALITY MONITORING AND MODELING NEAR COAL FIRED POWER PLANT, THERMAL SCIENCE, Volume: 23, Issue: 6, Pages: 4055-4065, ISSN: 0354-9836, eISSN: 2334-7163, 2019;

234. Xiao, D., Heaney, C.E., Fang, F., Mottet, L., Hu, R., Bistran, D.A., Aristodemou, E., Navon, I.M., Pain, C.C. A domain decomposition non-intrusive reduced order model for turbulent flows, *COMPUTERS & FLUIDS*, Volume: 182, Pages: 15-27, ISSN: 0045-7930, eISSN: 1879-0747, 2019;
235. Zamfira, A., Fat, R., Cenan, C. APPLYING SEMANTIC WEB TECHNOLOGIES TO DISCOVER AN ONTOLOGY OF COMPUTER ATTACKS, *SCALABLE COMPUTING-PRACTICE AND EXPERIENCE*, Volume: 20, Issue: 4, Special Issue: SI, Pages: 699-707, ISSN: 1895-1767, 2019;
236. Zamfira, A., Ciocarlie, H. INFERENCE SYSTEM TO ACHIEVE SATURATION OF (F, R, N) KNOWLEDGE BASES, *ACTA TECHNICA NAPOCENSIS SERIES-APPLIED MATHEMATICS MECHANICS AND ENGINEERING*, Volume: 62, Issue: 3, ISSN: 1221-5872, 2019.

* The data was obtained from Web of Science - Clarivate Analytics in 22 June 2020

Papers in ISI Proceedings

1. Adam, M., Muntean, D.M., Popov, M., Grecea, D., Ungureanu, V. Integrated energy efficient cooling solutions for large prefabricated panels collective dwellings from the 1970s, SUSTAINABLE SOLUTIONS FOR ENERGY AND ENVIRONMENT (EENVIRO 2018), Book Series: E3S Web of Conferences, Volume: 85, Article Number: 01004, Conference on Sustainable Solutions for Energy and Environment (EENVIRO), OCT 09-13, 2018, Cluj Napoca, ROMANIA, ISSN: 2267-1242, Published: 2019;
2. Alexa, V., Kiss, I., Cioata, V.G., Ratiu, S.A. Modelling and simulation of the asymmetric rolling process - establishing the optimal technology parameters to asymmetric rolling, INTERNATIONAL CONFERENCE ON APPLIED SCIENCES, Book Series: IOP Conference Series-Materials Science and Engineering, Volume: 477, Article Number: 012025, International Conference on Applied Sciences (ICAS), MAY 09-11, 2018, Banja Luke, BOSNIA & HERCEG, ISSN: 1757-8981, Published: 2019;
3. Alionescu, A., Herban, S., Vilceanu, C.B. 3D Modelling of Cultural Heritage Objective in Timisoara using precise LiDAR, INTERNATIONAL CONFERENCE ON NUMERICAL ANALYSIS AND APPLIED MATHEMATICS (ICNAAM-2018), Book Series: AIP Conference Proceedings, Volume: 2116, Article Number: 370002, International Conference on Numerical Analysis and Applied Mathematics (ICNAAM), SEP 13-18, 2018, Rhodes, GREECE, ISSN: 0094-243X, ISBN: 978-0-7354-1854-7, Published: 2019;
4. Ancuti, C.O., Ancuti, C., Sbert, M., Timofte, R. DENSE-HAZE: A BENCHMARK FOR IMAGE DEHAZING WITH DENSE-HAZE AND HAZE-FREE IMAGES, 2019 IEEE INTERNATIONAL CONFERENCE ON IMAGE PROCESSING (ICIP), Book Series: IEEE International Conference on Image Processing ICIP, Pages: 1014-1018, 26th IEEE International Conference on Image Processing (ICIP), SEP 22-25, 2019, Taipei, TAIWAN, ISSN: 1522-4880, ISBN: 978-1-5386-6249-6, Published: 2019;
5. Ancuti, C., Ancuti, C.O., Feixas, M., Sbert, M. IMAGE DECOLORIZATION BASED ON INFORMATION THEORY, 2019 IEEE INTERNATIONAL CONFERENCE ON IMAGE PROCESSING (ICIP), Book Series: IEEE International Conference on Image Processing ICIP, Pages: 3242-3246, 26th IEEE International Conference on Image Processing (ICIP), SEP 22-25, 2019, Taipei, TAIWAN, ISSN: 1522-4880, ISBN: 978-1-5386-6249-6, Published: 2019;
6. Ancuti, C.O., Kis, A., Ancuti, C. Evaluation of image dehazing techniques based on a realistic benchmark, 2019 61ST INTERNATIONAL SYMPOSIUM ELMAR, Book Series: ELMAR Proceedings, Pages: 61-64, 61st International ELMAR Symposium, SEP 23-25, 2019, Zadar, CROATIA, ISSN: 1334-2630, ISBN: 978-1-7281-2181-9, Published: 2019;
7. Andone, D., Ternauciu, A., Mihaescu, V., Vert, S. Developing the Open Virtual Mobility Learning Hub, DIGITAL EDUCATION: AT THE MOOC CROSSROADS WHERE THE INTERESTS OF ACADEMIA AND BUSINESS CONVERGE, Book Series: Lecture Notes in Computer Science, Volume: 11475, Pages: 111-120, 6th European MOOCs Stakeholders Summit (EMOOCs), MAY 20-22, 2019, Naples, ITALY, ISSN: 0302-9743, eISSN: 1611-3349, ISBN: 978-3-030-19875-6; 978-3-030-19874-9, Published: 2019;
8. Andreescu, I., Keller, A.I. Architecture as "Gesamtkunstwerk" - The Role of the Roof in Defining Architecture in the 19th and 20th Century in Timisoara, 3RD WORLD MULTIDISCIPLINARY CIVIL ENGINEERING, ARCHITECTURE, URBAN PLANNING SYMPOSIUM (WMCAUS 2018), Book Series: IOP Conference Series-Materials Science and Engineering, Volume: 471, Article Number: 072034, 3rd World Multidisciplinary Civil Engineering, Architecture, Urban Planning Symposium (WMCAUS), JUN 18-22, 2018, Prague, CZECH REPUBLIC, ISSN: 1757-8981, Published: 2019;
9. Andreica, T., Groza, B. Secure V2V Communication with Identity-based Cryptography from License Plate Recognition, 2019 SIXTH INTERNATIONAL CONFERENCE ON INTERNET OF THINGS: SYSTEMS, MANAGEMENT AND SECURITY (IOTSMS), Pages: 366-373, 6th International Conference on Internet of Things - Systems, Management and Security (IOTSMS), OCT 22-25, 2019, Granada, SPAIN, ISBN: 978-1-7281-2949-5, Published: 2019;
10. Anghel, A.A., Giurea, D., Milincu, C., Mohora, I., Preda, A.D., Frigura-Iliasa, F.M. A DIDACTIC APPROACH FOR INTERIOR DESIGN STUDENTS TOWARDS LEARNING THE DEVELOPMENT OF SPATIAL MODULAR STRUCTURES, 12TH INTERNATIONAL CONFERENCE OF EDUCATION, RESEARCH AND INNOVATION (ICERI 2019), Book Series: ICERI Proceedings, Pages: 5737-5744, 12th Annual International Conference of Education, Research and Innovation (ICERI), NOV 11-13, 2019, Seville, SPAIN, ISSN: 2340-1095, ISBN: 978-84-09-14755-7, Published: 2019;
11. Anghel, A.A., Milincu, C., Giurea, D., Mohora, I., Preda (Hapenciu), A.D., Frigura-Iliasa, F.M. NEW TOOLS FOR TEACHING SMART DESIGN, 12TH INTERNATIONAL CONFERENCE OF EDUCATION, RESEARCH AND INNOVATION (ICERI 2019), Book Series: ICERI Proceedings, Pages: 5681-5687, 12th Annual International Conference of Education, Research and Innovation (ICERI), NOV 11-13, 2019, Seville, SPAIN, ISSN: 2340-1095, ISBN: 978-84-09-14755-7, Published: 2019;

12. Anghel, A.A., Mohora, I., Frigura-Iliasa, F.M., Giurea, D., Preda, A.D., Milincu, C. Smart Responsive Green Walls for Public Transportation Areas in Timisoara, 2019 IEEE INTERNATIONAL CONFERENCE ON ENVIRONMENT AND ELECTRICAL ENGINEERING AND 2019 IEEE INDUSTRIAL AND COMMERCIAL POWER SYSTEMS EUROPE (EEEIC / I&CPS EUROPE), 19th IEEE International Conference on Environment and Electrical Engineering (EEEIC) / 3rd IEEE Industrial and Commercial Power Systems Europe Conference (I and CPS Europe), JUN 10-14, 2019, Genova, ITALY, ISBN: 978-1-7281-0652-6, Published: 2019;
13. Ardelean, E., Ardelean, M., Socalici, A., Putan, V., Putan, A. Researches on the influence of slag addition and secondary treatment duration on steel quality, INTERNATIONAL CONFERENCE ON APPLIED SCIENCES, Book Series: IOP Conference Series-Materials Science and Engineering, Volume: 477, Article Number: 012010, International Conference on Applied Sciences (ICAS), MAY 09-11, 2018, Banja Luke, BOSNIA & HERCEG, ISSN: 1757-8981, Published: 2019;
14. Arvinti, B., Toader, D., Costache, M. Frequency Correlated Filtering for Ambulatory Electrocardiograms, 2019 15TH INTERNATIONAL CONFERENCE ON ENGINEERING OF MODERN ELECTRIC SYSTEMS (EMES), Pages: 165-168, 15th International Conference on Engineering of Modern Electric Systems (EMES), JUN 13-14, 2019, Oradea, ROMANIA, ISBN: 978-1-7281-0773-8; Published: 2019;
15. Balint, C., De Sabata, A., Silaghi, A. Application of a Probabilistic Model to High Frequency Spectrum Occupancy, 2019 15TH INTERNATIONAL CONFERENCE ON ENGINEERING OF MODERN ELECTRIC SYSTEMS (EMES), Pages: 161-164, 15th International Conference on Engineering of Modern Electric Systems (EMES), JUN 13-14, 2019, Oradea, ROMANIA, ISBN: 978-1-7281-0773-8, Published: 2019;
16. Balint, C., De Sabata, A. Markov Model for HF Spectrum Occupancy, 2019 INTERNATIONAL SYMPOSIUM ON SIGNALS, CIRCUITS AND SYSTEMS (ISSCS 2019), 14th International Symposium on Signals, Circuits and Systems (ISSCS), JUL 11-12, 2019, Iasi, ROMANIA, ISBN: 978-1-7281-3896-1, Published: 2019;
17. Barb, G.R., Otesteanu, M., Budura, G., Balint, C. Performance Evaluation of TDL Channels for Downlink 5G MIMO Systems, 2019 INTERNATIONAL SYMPOSIUM ON SIGNALS, CIRCUITS AND SYSTEMS (ISSCS 2019), 14th International Symposium on Signals, Circuits and Systems (ISSCS), JUL 11-12, 2019, Iasi, ROMANIA, ISBN: 978-1-7281-3896-1, Published: 2019;
18. Berdie, A.D., Berdie, A.A., Jitian, S. The dependence of ellipsometric parameters Delta and Psi on refractive index of superficial film, INTERNATIONAL CONFERENCE ON APPLIED SCIENCES, Book Series: IOP Conference Series-Materials Science and Engineering, Volume: 477, Article Number: 012028, International Conference on Applied Sciences (ICAS), MAY 09-11, 2018, Banja Luke, BOSNIA & HERCEG, ISSN: 1757-8981, Published: 2019;
19. Birtok-Baneasa, C., Ratiu, S., Putan, V., Zgripcea, L. Experimental studies regarding the influence of the intake manifold material on the thermodynamics processes in the internal combustion engines, INTERNATIONAL CONFERENCE ON APPLIED SCIENCES, Book Series: IOP Conference Series-Materials Science and Engineering, Volume: 477, Article Number: 012006, International Conference on Applied Sciences (ICAS), MAY 09-11, 2018, Banja Luke, BOSNIA & HERCEG, ISSN: 1757-8981, Published: 2019;
20. Bocan, C., Bocan, D., Keller, A. Effects of Current Sunlight Exposure Regulations on New Housing, 3RD WORLD MULTIDISCIPLINARY CIVIL ENGINEERING, ARCHITECTURE, URBAN PLANNING SYMPOSIUM (WMCAUS 2018), Book Series: IOP Conference Series-Materials Science and Engineering, Volume: 471, Article Number: 082056, 3rd World Multidisciplinary Civil Engineering, Architecture, Urban Planning Symposium (WMCAUS), JUN 18-22, 2018, Prague, CZECH REPUBLIC, ISSN: 1757-8981, Published: 2019;
21. Bocan, D., Keller, A., Bocan, C., Apostol, I., Mosoarca, M. Potential Results of Using Current Thermal Rehabilitation Techniques on a City Block of Timisoara and their Structural Strengthening Opportunities, 3RD WORLD MULTIDISCIPLINARY CIVIL ENGINEERING, ARCHITECTURE, URBAN PLANNING SYMPOSIUM (WMCAUS 2018), Book Series: IOP Conference Series-Materials Science and Engineering, Volume: 471, Article Number: 062037, 3rd World Multidisciplinary Civil Engineering, Architecture, Urban Planning Symposium (WMCAUS), JUN 18-22, 2018, Prague, CZECH REPUBLIC, ISSN: 1757-8981, Published: 2019;
22. Bogdan, R., Pop, N., Holotescu, C. Using Web 2.0 Technologies for Teaching Technical Courses, TIM18 PHYSICS CONFERENCE, Book Series: AIP Conference Proceedings, Volume: 2071, Article Number: UNSP 050003, 18th Physics Conference (TIM), MAY 24-26, 2018, Timisoara, ROMANIA, ISSN: 0094-243X, ISBN: 978-0-7354-1799-1, Published: 2019;
23. Bogdan, S.L., Nedelcu, D., Padurean, I. The Reverse Engineering technique performed on a Francis Runner Geometry through Photogrammetry, INTERNATIONAL CONFERENCE ON APPLIED SCIENCES, Book Series: IOP Conference Series-Materials Science and Engineering, Volume: 477, Article Number: 012021, International Conference on Applied Sciences (ICAS), MAY 09-11, 2018, Banja Luke, BOSNIA & HERCEG, ISSN: 1757-8981, Published: 2019;

24. Boldea, I., Tutelea, L., Popa, A. Large variable speed generators design and their control: a revisit in 2019, 2019 INTERNATIONAL AEGEAN CONFERENCE ON ELECTRICAL MACHINES AND POWER ELECTRONICS (ACEMP) & 2019 INTERNATIONAL CONFERENCE ON OPTIMIZATION OF ELECTRICAL AND ELECTRONIC EQUIPMENT (OPTIM), Pages: 29-40, International Aegean Conference on Electrical Machines and Power Electronics (ACEMP) / International Conference on Optimization of Electrical and Electronic Equipment (OPTIM), AUG 27-29, 2019, Istanbul, TURKEY, ISBN: 978-1-5386-7687-5, Published: 2019;
25. Boldea, I., Tutelea, L.N., Torac, I., Marignetti, F. 10MW, 10rpm, 10Hz directly-driven cage rotor induction generator (CRIG): preliminary design with key FEM validations, 2019 INTERNATIONAL AEGEAN CONFERENCE ON ELECTRICAL MACHINES AND POWER ELECTRONICS (ACEMP) & 2019 INTERNATIONAL CONFERENCE ON OPTIMIZATION OF ELECTRICAL AND ELECTRONIC EQUIPMENT (OPTIM), Pages: 65-70, International Aegean Conference on Electrical Machines and Power Electronics (ACEMP) / International Conference on Optimization of Electrical and Electronic Equipment (OPTIM), AUG 27-29, 2019, Istanbul, TURKEY, ISBN: 978-1-5386-7687-5, Published: 2019;
26. Boldea, I., Tutelea, L.N., Xiao, X., Torac, I., Xu, W. Modified H-LSM for urban MAGLEVs, 2019 12TH INTERNATIONAL SYMPOSIUM ON LINEAR DRIVES FOR INDUSTRY APPLICATIONS (LDIA), 12th International Symposium on Linear Drives for Industry Applications (LDIA), JUL 01-03, 2019, Neuchatel, SWITZERLAND, ISBN: 978-1-5386-5804-8, Published: 2019;
27. Borborean, A.T., Stoica, V., Lelea, D. Test bench for studying the effects of water injection inside an internal combustion engine, INTERNATIONAL CONFERENCE ON APPLIED SCIENCES, Book Series: IOP Conference Series-Materials Science and Engineering, Volume: 477, Article Number: 012012, International Conference on Applied Sciences (ICAS), MAY 09-11, 2018, Banja Luke, BOSNIA & HERCEG, ISSN: 1757-8981, Published: 2019;
28. Bosioc, A.I., Mos, D.C., Muntean, S., Anton, L.E. ANALYSIS OF A CENTRIFUGAL PUMP EQUIPPED WITH AN AXIAL ROTOR WITH VARIABLE SPEED, PROCEEDINGS OF THE ASME/JSME/KSME JOINT FLUIDS ENGINEERING CONFERENCE, 2019, VOL 3B, Book Series: ASME JSME KSME Joint Fluids Engineering Conference Proceedings, Article Number: V03BT03A046, ASME-JSME-KSME Joint Fluids Engineering Conference (AJK-FED 2019), JUL 28-AUG 01, 2019, San Francisco, CA, ISSN: 2333-2506, ISBN: 978-0-7918-5905-6, Published: 2019;
29. Botila, D.A., Pop-Calimanu, I.M., Lascu, D., Lica, S. A Novel Buck-Boost Converter with Two Independently Controlled Switches, 2019 20TH INTERNATIONAL SYMPOSIUM ON POWER ELECTRONICS (EE), 20th International Symposium on Power Electronics (Ee), OCT 23-26, 2019, Novi Sad, SERBIA, ISBN: 978-1-7281-5067-3, Published: 2019;
30. Budiul-Berghian, A., Vasii, T., Birtok-Baneasa, C. Determination of Reliability for Dacia Solenza 1,9D, INTERNATIONAL CONFERENCE ON APPLIED SCIENCES, Book Series: IOP Conference Series-Materials Science and Engineering, Volume: 477, Article Number: 012044, International Conference on Applied Sciences (ICAS), MAY 09-11, 2018, Banja Luke, BOSNIA & HERCEG, ISSN: 1757-8981, Published: 2019;
31. Bulei, C., Todor, M.P., Kiss, I., Alexa, V. Aluminium matrix composites: Processing of matrix from re-melted aluminium wastes in micro-melting station, INTERNATIONAL CONFERENCE ON APPLIED SCIENCES, Book Series: IOP Conference Series-Materials Science and Engineering, Volume: 477, Article Number: 012049, International Conference on Applied Sciences (ICAS), MAY 09-11, 2018, Banja Luke, BOSNIA & HERCEG, ISSN: 1757-8981, Published: 2019;
32. But, A., Canarache, R. Comparative results of milling strategies implementation, MATERIALS TODAY-PROCEEDINGS, Volume: 12, Pages: 219-224, Part: 2, 35th Danubia Adria Symposium on Advances in Experimental Mechanics (DAS), SEP 25-28, 2018, Sinaia, ROMANIA, ISSN: 2214-7853, Published: 2019;
33. Buta, A.P., Silaghi, A.M., De Sabata, A., Matekovits, L. Fractal Based Frequency Selective Surface with Broadband Characteristics, 2019 INTERNATIONAL SYMPOSIUM ON SIGNALS, CIRCUITS AND SYSTEMS (ISSCS 2019), 14th International Symposium on Signals, Circuits and Systems (ISSCS), JUL 11-12, 2019, Iasi, ROMANIA, ISBN: 978-1-7281-3896-1, Published: 2019;
34. Caleanu, C.D., Simion, G. A Bag of Features Approach for CEUS Liver Lesions Investigation, 2019 42ND INTERNATIONAL CONFERENCE ON TELECOMMUNICATIONS AND SIGNAL PROCESSING (TSP), Pages: 323-326, 42nd International Conference on Telecommunications and Signal Processing (TSP), JUL 01-03, 2019, Budapest, HUNGARY, ISBN: 978-1-7281-1864-2, Published: 2019;
35. Chieffo, N., Mosoarca, M., Formisano, A., Apostol, I. Seismic Vulnerability Assessment and Loss Estimation of an Urban District of Timisoara, 3RD WORLD MULTIDISCIPLINARY CIVIL ENGINEERING, ARCHITECTURE, URBAN PLANNING SYMPOSIUM (WMCAUS 2018), Book Series: IOP Conference Series-Materials Science and Engineering, Volume: 471, Article Number: 102070, 3rd World Multidisciplinary Civil Engineering, Architecture, Urban Planning Symposium (WMCAUS), JUN 18-22, 2018, Prague, CZECH REPUBLIC, ISSN: 1757-8981, Published: 2019;

36. Chioncel, C.P., Gillich, N., Spunei, E., Tirian, O.G. Overview of the main topics in wind energy systems planning, INTERNATIONAL CONFERENCE ON APPLIED SCIENCES, Book Series: IOP Conference Series-Materials Science and Engineering, Volume: 477, Article Number: 012059, International Conference on Applied Sciences (ICAS), MAY 09-11, 2018, Banja Luke, BOSNIA & HERCEG, ISSN: 1757-8981, Published: 2019;
37. Cismariu, L., Dragomir, G.M., Cernicova-Buca, M. Online environment, the places where employers meet the new generation, PROCEEDINGS OF THE 14TH INTERNATIONAL CONFERENCE ON VIRTUAL LEARNING, ICVL 2019, Book Series: Proceedings of the International Conference on Virtual learning, Pages: 360-366, 14th International Conference on Virtual Learning (ICVL 2019), OCT 25-26, 2019, Bucharest, ROMANIA, ISSN: 1844-8933, Published: 2019;
38. Cismariu, L., Ciurel, D.L., Hosu, I. Generation Z and Social Media, PROCEEDINGS OF THE 14TH INTERNATIONAL CONFERENCE ON VIRTUAL LEARNING, ICVL 2019, Book Series: Proceedings of the International Conference on Virtual learning, Pages: 367-373, 14th International Conference on Virtual Learning (ICVL 2019), OCT 25-26, 2019, Bucharest, ROMANIA, ISSN: 1844-8933, Published: 2019;
39. Ciulica, D. Connection time study for 400 kV circuit breakers with SF6, INTERNATIONAL CONFERENCE ON APPLIED SCIENCES, Book Series: IOP Conference Series-Materials Science and Engineering, Volume: 477, Article Number: 012015, International Conference on Applied Sciences (ICAS), MAY 09-11, 2018, Banja Luke, BOSNIA & HERCEG, ISSN: 1757-8981, Published: 2019;
40. Codrean, C., Buzdugan, D., Opris, C., Hididis, P., Serban, V.A. Obtaining of bulk amorphous steel with low carbon content using industrial ferroalloys, MATERIALS TODAY-PROCEEDINGS, Volume: 19, Pages: 991-995, Part: 3, 11th International Conference on Materials Science and Engineering (BraMat), MAR 13-16, 2019, Brasov, ROMANIA, ISSN: 2214-7853, Published: 2019;
41. Cojocariu, N., Humita, M., Jadaneant, M. Economic Impact of Horizontal Metering in District Heat Systems, EDUCATION EXCELLENCE AND INNOVATION MANAGEMENT THROUGH VISION 2020, Pages: 2294-2300, 33rd International-Business-Information-Management-Association Conference, APR 10-11, 2019, Granada, SPAIN, ISBN: 978-0-9998551-2-6, Published: 2019;
42. Costea, F.M., Chirila, C.B., Cretu, V.I. Redesigning Educational Tools Using Auto-Generative Learning Objects, NEW TECHNOLOGIES AND REDESIGNING LEARNING SPACES, VOL II, Book Series: eLearning and Software for Education, Pages: 345-350, 15th International Scientific Conference on eLearning and Software for Education (eLSE) - New Technologies and Redesigning Learning Spaces, APR 11-12, 2019, Bucharest, ROMANIA, ISSN: 2066-026X, Published: 2019;
43. Crisan, M. Dynamic Neural Network Model of Speech Perception, ADVANCES IN COMPUTER COMMUNICATION AND COMPUTATIONAL SCIENCES, IC4S 2018, Book Series: Advances in Intelligent Systems and Computing, Volume: 924, Pages: 365-375, International Conference on Computer, Communication and Computational Sciences (IC4S), OCT 20-21, 2018, Bangkok, THAILAND, ISSN: 2194-5357, eISSN: 2194-5365, ISBN: 978-981-13-6861-5; 978-981-13-6860-8, Published: 2019;
44. Csukas, E.S., Duma, V.F. Optical choppers with spherical shafts: An optomechanical analysis, OPTICAL SENSORS 2019, Book Series: Proceedings of SPIE, Volume: 11028, Article Number: 1102805, Conference on Optical Sensors, APR 01-04, 2019, Prague, CZECH REPUBLIC, ISSN: 0277-786X, eISSN: 1996-756X, ISBN: 978-1-5106-2723-9, Published: 2019;
45. Csukas, E.S., Demian, D., Duma, V.F. Optomechanical choppers with conical shafts: A Finite Element Analysis, SENSORS, SYSTEMS, AND NEXTGENERATION SATELLITES XXIII, Book Series: Proceedings of SPIE, Volume: 11151, Article Number: 1115122, Conference on Sensors, Systems, and Next- Generation Satellites XXIII, SEP 09-12, 2019, Strasbourg, FRANCE, ISSN: 0277-786X, eISSN: 1996-756X, ISBN: 978-1-5106-3006-2, Published: 2019;
46. Cuntan, C.D., Baci, I., Dinis, C.M. Xilinx implementation of a serial-parallel digital converter, INTERNATIONAL CONFERENCE ON APPLIED SCIENCES, Book Series: IOP Conference Series-Materials Science and Engineering, Volume: 477, Article Number: 012035, International Conference on Applied Sciences (ICAS), MAY 09-11, 2018, Banja Luke, BOSNIA & HERCEG, ISSN: 1757-8981, Published: 2019;
47. Dehelean, T., Naformita, C., Isar, A. Estimate's Statistics in the Performance Evaluation of Extended Object Tracker, 2019 INTERNATIONAL SYMPOSIUM ON SIGNALS, CIRCUITS AND SYSTEMS (ISSCS 2019), 14th International Symposium on Signals, Circuits and Systems (ISSCS), JUL 11-12, 2019, Iasi, ROMANIA, ISBN: 978-1-7281-3896-1, Published: 2019;
48. Diaconescu, A., Tamasila, M., Prostean, G. Adding a Blue Ocean in Higher Education: Collaboration Through It Technologies as Part of the Engineering Skills Set, EDUCATION EXCELLENCE AND INNOVATION MANAGEMENT THROUGH VISION 2020, Pages: 9162-9173, 33rd International-Business-Information-Management-Association (IBIMA) Conference, APR 10-11, 2019, Granada, SPAIN, ISBN: 978-0-9998551-2-6, Published: 2019;

49. Dimb, A.L., Duma, V.F. Graphical method to determine exact scan patterns generated with rotational Risley prisms, OPTICS AND MEASUREMENT INTERNATIONAL CONFERENCE 2019, Book Series: Proceedings of SPIE, Volume: 11385, Article Number: UNSP 1138503, Optics and Measurement International Conference, OCT 08-10, 2019, Liberec, CZECH REPUBLIC, ISSN: 0277-786X, eISSN: 1996-756X, ISBN: 978-1-5106-3548-7, Published: 2019;
50. Dinis, C.M., Popa, G.N., Cuntan, C.D., Iagar, A. An analyse on analogue ESR-meter, INTERNATIONAL CONFERENCE ON APPLIED SCIENCES, Book Series: IOP Conference Series-Materials Science and Engineering, Volume: 477, Article Number: 012031, International Conference on Applied Sciences (ICAS), MAY 09-11, 2018, Banja Luke, BOSNIA & HERCEG, ISSN: 1757-8981, Published: 2019;
51. Draghicescu, D., Tucu, D., Ghergan, O.C., Iusco, A. NUTS VARIETIES INFLUENCE ON WALNUT BREAKING AND PEELING PROCESS, AKTUALNI ZADACI MEHANIZACIJE POLJOPRIVREDE: ZBORNIK RADOVA: ACTUAL TASKS ON AGRICULTURAL ENGINEERING. PROCEEDINGS, Book Series: Actual Tasks on Agricultural Engineering-Zagreb, Volume: 47, Pages: 419-427, 47th Symposium on Actual Tasks on Agricultural Engineering, MAR 05-07, 2019, Opatija, CROATIA, ISSN: 1848-4425, Published: 2019;
52. Dufour, C., Pana, A.M., Dumitreț, G.A. OCCUPATIONAL HEALTH AND SAFETY EDUCATION: THE PREVENTION AND PROTECTION PLAN IN UNIVERSITY CHEMICAL LABORATORIES, 12TH INTERNATIONAL CONFERENCE OF EDUCATION, RESEARCH AND INNOVATION (ICERI 2019), Book Series: ICERI Proceedings, Pages: 1546-1550, 12th Annual International Conference of Education, Research and Innovation (ICERI), NOV 11-13, 2019, Seville, SPAIN, ISSN: 2340-1095, ISBN: 978-84-09-14755-7, Published: 2019;
53. Duma, M.A., Duma, V.F. Theoretical approach on the linearity increase of scanning functions using supplemental mirrors, OPTICAL SENSORS 2019, Book Series: Proceedings of SPIE, Volume: 11028, Article Number: 1102817, Conference on Optical Sensors, APR 01-04, 2019, Prague, CZECH REPUBLIC, ISSN: 0277-786X, eISSN: 1996-756X, ISBN: 978-1-5106-2723-9, Published: 2019;
54. Erdelyi, R.A., Duma, V.F. Optimization of Radiation Doses and Patients' Risk in Dental Radiography, TIM18 PHYSICS CONFERENCE, Book Series: AIP Conference Proceedings, Volume: 2071, Article Number: UNSP 040013, 18th Physics Conference (TIM), MAY 24-26, 2018, Timișoara, ROMANIA, ISSN: 0094-243X, ISBN: 978-0-7354-1799-1, Published: 2019;
55. Erdelyi, R.A., Duma, V.F., Dobre, G., Bradu, A., Podoleanu, A.G. Investigations of dental cavities: between X-ray radiography and OCT, OPTICS AND MEASUREMENT INTERNATIONAL CONFERENCE 2019, Book Series: Proceedings of SPIE, Volume: 11385, Article Number: UNSP 1138504, Optics and Measurement International Conference, OCT 08-10, 2019, Liberec, CZECH REPUBLIC, ISSN: 0277-786X, eISSN: 1996-756X, ISBN: 978-1-5106-3548-7, Published: 2019;
56. Falk, A., Marsavina, L., Pop, O. Experimental determination of strain distribution on Printed Circuit Boards using Digital image correlation, 25TH INTERNATIONAL CONFERENCE ON FRACTURE AND STRUCTURAL INTEGRITY, Book Series: Procedia Structural Integrity, Volume: 18, Pages: 214-222, 25th International Conference on Fracture and Structural Integrity, JUN 12-14, 2019, Catania, ITALY, ISSN: 2452-3216, Published: 2019;
57. Filip, M.E., Csaba, G., Lelea, D. Comparative analysis of heat recovery methods from internal combustion engines, INTERNATIONAL CONFERENCE ON APPLIED SCIENCES, Book Series: IOP Conference Series-Materials Science and Engineering, Volume: 477, Article Number: 012011, International Conference on Applied Sciences (ICAS), MAY 09-11, 2018, Banja Luke, BOSNIA & HERCEG, ISSN: 1757-8981, Published: 2019;
58. Filipescu, H., Papazian, P. VHDL-AMS modelling and FPGA implementation of Electrodermal Centers Analyzer, 2019 42ND INTERNATIONAL CONFERENCE ON TELECOMMUNICATIONS AND SIGNAL PROCESSING (TSP), Pages: 424-427, 42nd International Conference on Telecommunications and Signal Processing (TSP), JUL 01-03, 2019, Budapest, HUNGARY, ISBN: 978-1-7281-1864-2, Published: 2019;
59. Florescu R.E., Bica S.M. INTERDISCIPLINARY APPROACH IN PROMOTING EARTH CONSTRUCTION TECHNIQUES IN THE BANAT REGION, ROMANIA, PROCEEDINGS OF INTCESS 2019- 6TH INTERNATIONAL CONFERENCE ON EDUCATION AND SOCIAL SCIENCES, Pages: 1102-1110, 6th International Conference on Education and Social Sciences (INTCESS), FEB 04-06, 2019, Dubai, U ARAB EMIRATES, ISBN: 978-605-82433-5-4, Published: 2019;
60. Frigura-Iliasa, M., Baloi, F.I., Olariu, A.F., Petrenci, R.C. Magnetic Field Assessment in the Proximity of High Voltage Power Station Equipment, PROCEEDINGS OF THE 2019 20TH INTERNATIONAL SCIENTIFIC CONFERENCE ON ELECTRIC POWER ENGINEERING (EPE), Book Series: International Scientific Conference on Electric Power Engineering, Pages: 287-290, 20th International Scientific Conference on Electric Power Engineering (EPE), MAY 15-17, 2019, CZECH REPUBLIC, ISSN: 2376-5623, ISBN: 978-1-7281-1333-3, Published: 2019;

61. Frigura-Iliasa, M., Iorga, M., Dolga, L., Filipescu, H.E. Computer Based Algorithm for Optimizing Design and Construction of Large Industrial Power System Industrial Objectives, 2019 IEEE 17TH WORLD SYMPOSIUM ON APPLIED MACHINE INTELLIGENCE AND INFORMATICS (SAMI 2019), Pages: 59-62, 17th IEEE World Symposium on Applied Machine Intelligence and Informatics (SAMI), JAN 24-26, 2019, Herlany, SLOVAKIA, ISBN: 978-1-7281-0250-4, Published: 2019;
62. Gabor, E., Beilicci, E., Beilicci, R. Advanced Hydroinformatic Tools for Modelling of Reservoirs Operation, 3RD WORLD MULTIDISCIPLINARY CIVIL ENGINEERING, ARCHITECTURE, URBAN PLANNING SYMPOSIUM (WMCAUS 2018), Book Series: IOP Conference Series-Materials Science and Engineering, Volume: 471, Article Number: 042002, 3rd World Multidisciplinary Civil Engineering, Architecture, Urban Planning Symposium (WMCAUS), JUN 18-22, 2018, Prague, CZECH REPUBLIC, ISSN: 1757-8981, Published: 2019;
63. Georgescu, M., Ungureanu, V., Marsavina, L., Floricel, A., Gruin, A. Composite Roofing of PIR Sandwich Panels: Numerical and Experimental Approach, 3RD WORLD MULTIDISCIPLINARY CIVIL ENGINEERING, ARCHITECTURE, URBAN PLANNING SYMPOSIUM (WMCAUS 2018), Book Series: IOP Conference Series-Materials Science and Engineering, Volume: 471, Article Number: 052092, 3rd World Multidisciplinary Civil Engineering, Architecture, Urban Planning Symposium (WMCAUS), JUN 18-22, 2018, Prague, CZECH REPUBLIC, ISSN: 1757-8981, Published: 2019;
64. Ghergan, O.C., Tucu, D., Iusco, A., Draghicescu, D., Babanatis Merce, R.M. SMALL GREENHOUSE ROBOTIZED SOLUTIONS: STATE OF THE ART AND FUTURE PERSPECTIVES, AKTUALNI ZADACI MEHANIZACIJE POLJOPRIVREDE: ZBORNIK RADOVA: ACTUAL TASKS ON AGRICULTURAL ENGINEERING. PROCEEDINGS, Book Series: Actual Tasks on Agricultural Engineering-Zagreb, Volume: 47, Pages: 267-276, 47th Symposium on Actual Tasks on Agricultural Engineering, MAR 05-07, 2019, Opatija, CROATIA, ISSN: 1848-4425, Published: 2019;
65. Ghiormez, L., Panoiu, M., Panoiu, C., Muscalagiu, I. Proportional regulator-based approach for a three-phase electric arc furnace, INTERNATIONAL CONFERENCE ON APPLIED SCIENCES, Book Series: IOP Conference Series-Materials Science and Engineering, Volume: 477, Article Number: 012016, International Conference on Applied Sciences (ICAS), MAY 09-11, 2018, Banja Luke, BOSNIA & HERCEG, ISSN: 1757-8981, Published: 2019;
66. Gradinaru, C., Beilicci, R., Beilicci, E. Advance Hydraulic Modelling of Maciovita River, Caras Severin County, Romania, 3RD WORLD MULTIDISCIPLINARY CIVIL ENGINEERING, ARCHITECTURE, URBAN PLANNING SYMPOSIUM (WMCAUS 2018), Book Series: IOP Conference Series-Materials Science and Engineering, Volume: 471, Article Number: 042001, 3rd World Multidisciplinary Civil Engineering, Architecture, Urban Planning Symposium (WMCAUS), JUN 18-22, 2018, Prague, CZECH REPUBLIC, ISSN: 1757-8981, Published: 2019;
67. Grozav, A., Rogobete, G. Criteria and Mathematical Expressions for Evaluating an Illuvial Accumulation of Clay in Luvisols, 3RD WORLD MULTIDISCIPLINARY CIVIL ENGINEERING, ARCHITECTURE, URBAN PLANNING SYMPOSIUM (WMCAUS 2018), Book Series: IOP Conference Series-Materials Science and Engineering, Volume: 471, Article Number: 042011, 3rd World Multidisciplinary Civil Engineering, Architecture, Urban Planning Symposium (WMCAUS), JUN 18-22, 2018, Prague, CZECH REPUBLIC, ISSN: 1757-8981, Published: 2019;
68. Halbac-Cotoara-Zamfir, C., Halbac-Cotoara-Zamfir, R., De Miranda, J.H. ECONOMIC DESIGN OF DRAIN DEPTHS AND SPACING USING DIFFERENT EU AND NON-EU MODELS, AKTUALNI ZADACI MEHANIZACIJE POLJOPRIVREDE: ZBORNIK RADOVA: ACTUAL TASKS ON AGRICULTURAL ENGINEERING. PROCEEDINGS, Book Series: Actual Tasks on Agricultural Engineering-Zagreb, Volume: 47, Pages: 167-174, 47th Symposium on Actual Tasks on Agricultural Engineering, MAR 05-07, 2019, Opatija, CROATIA, ISSN: 1848-4425, Published: 2019;
69. Halbac-Cotoara-Zamfir, R. NATURE-BASED SOLUTIONS FOR FLOOD RISK MANAGEMENT: A ROMANIAN CASE STUDY, AKTUALNI ZADACI MEHANIZACIJE POLJOPRIVREDE: ZBORNIK RADOVA: ACTUAL TASKS ON AGRICULTURAL ENGINEERING. PROCEEDINGS, Book Series: Actual Tasks on Agricultural Engineering-Zagreb, Volume: 47, Pages: 175-181, 47th Symposium on Actual Tasks on Agricultural Engineering, MAR 05-07, 2019, Opatija, CROATIA, ISSN: 1848-4425, Published: 2019;
70. Hedes, A., Vitan, L.D., Tudoran, C.A., Muntean, O. Experimental Research on Electrocoagulation for Wastewater Treatment, 2019 20TH INTERNATIONAL SYMPOSIUM ON POWER ELECTRONICS (EE), 20th International Symposium on Power Electronics (Ee), OCT 23-26, 2019, Novi Sad, SERBIA, ISBN: 978-1-7281-5067-3, Published: 2019;
71. Hedrea, E.L., Precup, R.E., Bojan-Dragos, C.A., Petriu, E.M., Roman, R.C. Tensor Product-Based Model Transformation and Sliding Mode Control of Electromagnetic Actuated Clutch System, 2019 IEEE INTERNATIONAL CONFERENCE ON SYSTEMS, MAN AND CYBERNETICS (SMC), Book Series: IEEE International Conference on Systems Man and Cybernetics Conference Proceedings, Pages: 1402-1407, IEEE International Conference on Systems, Man and Cybernetics (SMC), OCT 06-09, 2019, Bari, ITALY, ISSN: 1062-922X, ISBN: 978-1-7281-4569-3, Published: 2019;

72. Herisanu, N., Marinca, V. Optimal Homotopy Asymptotic Method in the Study of Energy Harvesting Problems, INTERNATIONAL CONFERENCE ON NUMERICAL ANALYSIS AND APPLIED MATHEMATICS (ICNAAM-2018), Book Series: AIP Conference Proceedings, Volume: 2116, Article Number: 300002, International Conference on Numerical Analysis and Applied Mathematics (ICNAAM), SEP 13-18, 2018, Rhodes, GREECE, ISSN: 0094-243X, ISBN: 978-0-7354-1854-7, Published: 2019;
73. Hradil, P., Fulop, L., Ungureanu, V. Assessment of reusability of components from single-storey steel buildings, LIFE-CYCLE ANALYSIS AND ASSESSMENT IN CIVIL ENGINEERING: TOWARDS AN INTEGRATED VISION, Pages: 2451-2457, 6th International Symposium on Life-Cycle Civil Engineering (IALCCE), OCT 28-31, 2018, Ghent, BELGIUM, ISBN: 978-1-315-22891-4; 978-1-138-62633-1, Published: 2019;
74. Hudrea, I.C., Totorean, A.F., Gaita, D. Computational Fluid Dynamics Analysis of Coronary Stent Malapposition, WORLD CONGRESS ON MEDICAL PHYSICS AND BIOMEDICAL ENGINEERING 2018, VOL 1, Book Series: IFMBE Proceedings, Volume: 68, Issue: 1, Pages: 761-765, IUPESM World Congress on Medical Physics and Biomedical Engineering, JUN 03-08, 2018, Prague, CZECH REPUBLIC, ISSN: 1680-0737, ISBN: 978-981-10-9035-6; 978-981-10-9034-9, Published: 2019;
75. Hulea, D., Gireada, M., Muntean, N., Cornea, O. A Bidirectional Hybrid Switched-Capacitor DC-DC Converter with a High Voltage Gain, 2019 INTERNATIONAL AEGEAN CONFERENCE ON ELECTRICAL MACHINES AND POWER ELECTRONICS (ACEMP) & 2019 INTERNATIONAL CONFERENCE ON OPTIMIZATION OF ELECTRICAL AND ELECTRONIC EQUIPMENT (OPTIM), Pages: 289-296, International Aegean Conference on Electrical Machines and Power Electronics (ACEMP) / International Conference on Optimization of Electrical and Electronic Equipment (OPTIM), AUG 27-29, 2019, Istanbul, TURKEY, ISBN: 978-1-5386-7687-5, Published: 2019;
76. Hulea, D., Muntean, N., Gireada, M., Cornea, O., Serban, E. Bidirectional Hybrid Switched-Inductor Switched-Capacitor Converter Topology with High Voltage Gain, 2019 21ST EUROPEAN CONFERENCE ON POWER ELECTRONICS AND APPLICATIONS (EPE '19 ECCE EUROPE), Book Series: European Conference on Power Electronics and Applications, 21st European Conference on Power Electronics and Applications (EPE ECCE Europe), SEP 03-05, 2019, Genova, ITALY, ISSN: 2325-0313, ISBN: 978-9-0758-1531-3, Published: 2019;
77. Humita, M., Cojocariu, N., Jadaneant, M. Managerial Considerations Regarding the Modernization of District Heating Companies in Eastern Europe, EDUCATION EXCELLENCE AND INNOVATION MANAGEMENT THROUGH VISION 2020, Pages: 2860-2867, 33rd International-Business-Information-Management-Association Conference, APR 10-11, 2019, Granada, SPAIN, ISBN: 978-0-9998551-2-6, Published: 2019;
78. Hutiu, G., Duma, V.F., Demian, D., Dimb, A.L., Erdelyi, R.A., Bradu, A., Podoleanu, A.G. Metallic fractures assessments: OCT versus SEM, OPTICS AND MEASUREMENT INTERNATIONAL CONFERENCE 2019, Book Series: Proceedings of SPIE, Volume: 11385, Article Number: UNSP 1138507, Optics and Measurement International Conference, OCT 08-10, 2019, Liberec, CZECH REPUBLIC, ISSN: 0277-786X, eISSN: 1996-756X, ISBN: 978-1-5106-3548-7, Published: 2019;
79. Iacob, F., Pop, N., Mezei, J.Z., Epee, M.D.E., Motapon, O., Niyonzima, S., Laporta, V., Schneider, I.F. Recombination and Excitation of Molecular Cations with Electrons: Application to H-2(+), BeD+ and BeT+, TIM18 PHYSICS CONFERENCE, Book Series: AIP Conference Proceedings, Volume: 2071, Article Number: 020007, 18th Physics Conference (TIM), MAY 24-26, 2018, Timisoara, ROMANIA, ISSN: 0094-243X, ISBN: 978-0-7354-1799-1, Published: 2019;
80. Iacobici, N.L., Cazacu, E., Frigura-Iliasa, M., Frigura-Iliasa, F.M. Computer Based Analysis for the Parameters of a Distribution Transformer in a Non-Sinusoidal Regime, 2019 IEEE 17TH WORLD SYMPOSIUM ON APPLIED MACHINE INTELLIGENCE AND INFORMATICS (SAMI 2019), Pages: 371-374, 17th IEEE World Symposium on Applied Machine Intelligence and Informatics (SAMI), JAN 24-26, 2019, Herlany, SLOVAKIA, ISBN: 978-1-7281-0250-4, Published: 2019;
81. Iagar, A., Popa, G.N., Dinis, C.M. Investigation of harmonic pollution produced by power tools, INTERNATIONAL CONFERENCE ON APPLIED SCIENCES, Book Series: IOP Conference Series-Materials Science and Engineering, Volume: 477, Article Number: 012039, International Conference on Applied Sciences (ICAS), MAY 09-11, 2018, Banja Luke, BOSNIA & HERCEG, ISSN: 1757-8981, Published: 2019;
82. Iagar, A., Popa, G.N., Dinis, C.M. Experimental Analysis of a High-Frequency Induction Furnace and its Impact on Power Quality, 2019 11TH INTERNATIONAL SYMPOSIUM ON ADVANCED TOPICS IN ELECTRICAL ENGINEERING (ATEE), Book Series: International Symposium on Advanced Topics in Electrical Engineering, 11th International Symposium on Advanced Topics in Electrical Engineering (ATEE), MAR 28-30, 2019, Bucharest, ROMANIA, ISSN: 1843-8571, ISBN: 978-1-4799-7514-3, Published: 2019;

83. Ilca, I. Structural research at high temperature on industrial semi-finished products made from thermostable stainless steels, INTERNATIONAL CONFERENCE ON APPLIED SCIENCES, Book Series: IOP Conference Series-Materials Science and Engineering, Volume: 477, Article Number: 012001, International Conference on Applied Sciences (ICAS), MAY 09-11, 2018, Banja Luke, BOSNIA & HERCEG, ISSN: 1757-8981, Published: 2019;
84. Ilca, I., Kiss, I., Milostean, D. Study on the quality of Boron micro-alloyed steels destined to applications in the automotive sector, INTERNATIONAL CONFERENCE ON APPLIED SCIENCES, Book Series: IOP Conference Series-Materials Science and Engineering, Volume: 477, Article Number: 012003, International Conference on Applied Sciences (ICAS), MAY 09-11, 2018, Banja Luke, BOSNIA & HERCEG, ISSN: 1757-8981, Published: 2019;
85. Ioan, V., Beilicci, R., Beilicci, E. Evolution in Time (1980-2014) of Drought Based on Several Computation Indexes. Case Study of Banloc, Romania, 3RD WORLD MULTIDISCIPLINARY CIVIL ENGINEERING, ARCHITECTURE, URBAN PLANNING SYMPOSIUM (WMCAUS 2018), Book Series: IOP Conference Series-Materials Science and Engineering, Volume: 471, Article Number: 042033, 3rd World Multidisciplinary Civil Engineering, Architecture, Urban Planning Symposium (WMCAUS), JUN 18-22, 2018, Prague, CZECH REPUBLIC, ISSN: 1757-8981, Published: 2019;
86. Ioana, A., Korodi, A. VSOMEIP - OPC UA Gateway Solution for the Automotive Industry, 2019 IEEE INTERNATIONAL CONFERENCE ON ENGINEERING, TECHNOLOGY AND INNOVATION (ICE/ITMC), Book Series: International ICE Conference on Engineering Technology and Innovation, 25th IEEE International Conference on Engineering, Technology and Innovation / 25th ICE/IEEE International Technology Management Conference (ITMC), JUN 17-19, 2019, FRANCE, ISSN: 2334-315X, ISBN: 978-1-7281-3401-7, Published: 2019;
87. Iordan, A.E. Optimal solution of the Guarini puzzle extension using tripartite graphs, INTERNATIONAL CONFERENCE ON APPLIED SCIENCES, Book Series: IOP Conference Series-Materials Science and Engineering, Volume: 477, Article Number: 012046, International Conference on Applied Sciences (ICAS), MAY 09-11, 2018, Banja Luke, BOSNIA & HERCEG, ISSN: 1757-8981, Published: 2019;
88. Isar, A., Nafornita, C., Isar, D. Aliasing Error Upper Bounds in Case of Digital Signals Uniform Sampling, 2019 INTERNATIONAL SYMPOSIUM ON SIGNALS, CIRCUITS AND SYSTEMS (ISSCS 2019), 14th International Symposium on Signals, Circuits and Systems (ISSCS), JUL 11-12, 2019, Iasi, ROMANIA, ISBN: 978-1-7281-3896-1, Published: 2019;
89. Iusco, A., Tucu, D., Ghergan, O.C., Lica, S. ENERGY PRODUCTION FROM THE WALK OF THE ANIMALS IN PADDOCK BY THE USE OF PIEZOELECTRIC ELEMENTS, AKTUALNI ZADACI MEHANIZACIJE POLJOPRIVREDE: ZBORNIK RADOVA: ACTUAL TASKS ON AGRICULTURAL ENGINEERING. PROCEEDINGS, Book Series: Actual Tasks on Agricultural Engineering-Zagreb, Volume: 47, Pages: 473-478, 47th Symposium on Actual Tasks on Agricultural Engineering, MAR 05-07, 2019, Opatija, CROATIA, ISSN: 1848-4425, Published: 2019;
90. Ivascu, L., Ardelean, B.O., Turi, A., Gaureanu, A., Balan, M. Business Models for Sustainable Development in the Circular Economy Context, EDUCATION EXCELLENCE AND INNOVATION MANAGEMENT THROUGH VISION 2020, Pages: 5326-5334, 33rd International-Business-Information-Management-Association (IBIMA) Conference, APR 10-11, 2019, Granada, SPAIN, ISBN: 978-0-9998551-2-6, Published: 2019;
91. Josan, A., Pinca-Bretotean, C., Ratiu, S. Researches and studies regarding the casting of brake drums from cast iron, INTERNATIONAL CONFERENCE ON APPLIED SCIENCES, Book Series: IOP Conference Series-Materials Science and Engineering, Volume: 477, Article Number: 012033, International Conference on Applied Sciences (ICAS), MAY 09-11, 2018, Banja Luke, BOSNIA & HERCEG, ISSN: 1757-8981, Published: 2019;
92. Kis, A., Ancuti, C., Ancuti, C.O. ATS-PCB: An Effective Automated Testing System for Advanced Driver Assistance Systems, 2019 61ST INTERNATIONAL SYMPOSIUM ELMAR, Book Series: ELMAR Proceedings, Pages: 215-218, 61st International ELMAR Symposium, SEP 23-25, 2019, Zadar, CROATIA, ISSN: 1334-2630, ISBN: 978-1-7281-2181-9, Published: 2019;
93. Lala, T., Radac, M.B. Parameterized value iteration for output reference model tracking of a high order nonlinear aerodynamic system, 2019 27TH MEDITERRANEAN CONFERENCE ON CONTROL AND AUTOMATION (MED), Book Series: Mediterranean Conference on Control and Automation, Pages: 43-49, 27th Mediterranean Conference on Control and Automation, JUL 01-04, 2019, Akko, ISRAEL, ISSN: 2325-369X, ISBN: 978-1-7281-2803-0, Published: 2019;
94. Lapadat, M., Pasca, M. Approximate Solutions of the Nonlinear Standard Lane-Emden Equation using the LSDQ Method, INTERNATIONAL CONFERENCE ON NUMERICAL ANALYSIS AND APPLIED MATHEMATICS (ICNAAM-2018), Book Series: AIP Conference Proceedings, Volume: 2116, Article Number: 370003, International Conference on Numerical Analysis and Applied Mathematics (ICNAAM), SEP 13-18, 2018, Rhodes, GREECE, ISSN: 0094-243X, ISBN: 978-0-7354-1854-7, Published: 2019;

95. Lazar, I., Bordeasu, I., Popoviciu, M.O., Mitelea, I., Craciunescu, C.M., Pirvulescu, L.D., Sava, M., Micu, L.M. Evaluation of the brass CuZn39Pb3 resistance at vibratory cavitation erosion, INTERNATIONAL CONFERENCE ON APPLIED SCIENCES, Book Series: IOP Conference Series-Materials Science and Engineering, Volume: 477, Article Number: 012002, International Conference on Applied Sciences (ICAS), MAY 09-11, 2018, Banja Luke, BOSNIA & HERCEG, ISSN: 1757-8981, Published: 2019;
96. Lazarescu, E., Cazacu, E., Frigura-Iliasa, M., Frigura-Iliasa, F.M. Computational Model for the Dimensioning of Neutral Conductor in Low Voltage Power Networks Operating in Various Regimes, 2019 IEEE 17TH WORLD SYMPOSIUM ON APPLIED MACHINE INTELLIGENCE AND INFORMATICS (SAMI 2019), Pages: 361-364, 17th IEEE World Symposium on Applied Machine Intelligence and Informatics (SAMI), JAN 24-26, 2019, Herlany, SLOVAKIA, ISBN: 978-1-7281-0250-4, Published: 2019;
97. Lazareanu, C. Chaotic Behavior of an Integrable Deformation of a Nonlinear Monetary System, INTERNATIONAL CONFERENCE ON NUMERICAL ANALYSIS AND APPLIED MATHEMATICS (ICNAAM-2018), Book Series: AIP Conference Proceedings, Volume: 2116, Article Number: 370004, International Conference on Numerical Analysis and Applied Mathematics (ICNAAM), SEP 13-18, 2018, Rhodes, GREECE, ISSN: 0094-243X, ISBN: 978-0-7354-1854-7, Published: 2019;
98. Lovasz, E.C., Gruescu, C.M., Vutan, A.M., Margineanu, D.T. Dynamic Study of an Adaptive Intelligent Cervical Brace Model Under Actuation, MECHANISM DESIGN FOR ROBOTICS, Book Series: Mechanisms and Machine Science, Volume: 66, Pages: 327-334, 4th IFToMM Symposium on Mechanism Design for Robotics (MEDER), SEP 11-13, 2018, Udine, ITALY, ISSN: 2211-0984, eISSN: 2211-0992, ISBN: 978-3-030-00365-4; 978-3-030-00364-7, Published: 2019;
99. Lovasz, E.C., Ceccarelli, M., Gruescu, C.M., Carbone, G., Carabas, I. A Comparative Analysis of Teaching MMS at Politehnica University of Timisoara and University of Cassino and South Latium, NEW TRENDS IN EDUCATIONAL ACTIVITY IN THE FIELD OF MECHANISM AND MACHINE THEORY 2014-2017, Book Series: Mechanisms and Machine Science, Volume: 64, Pages: 91-102, 2nd International Symposium on the Education in Mechanism and Machine Science (ISEMMS), NOV 23-24, 2017, Madrid, SPAIN, ISSN: 2211-0984, eISSN: 2211-0992, ISBN: 978-3-030-00108-7; 978-3-030-00107-0, Published: 2019;
100. Lovasz, E.A., Lascu, D. Universal Controller for Quasiresonant and LLC Converters, 2019 42ND INTERNATIONAL CONFERENCE ON TELECOMMUNICATIONS AND SIGNAL PROCESSING (TSP), Pages: 513-516, 42nd International Conference on Telecommunications and Signal Processing (TSP), JUL 01-03, 2019, Budapest, HUNGARY, ISBN: 978-1-7281-1864-2, Published: 2019;
101. Lup, P.S., Prosteau, G.I. Consumer Protection Model in Romania against Subliminal Messages in TV Ads, EDUCATION EXCELLENCE AND INNOVATION MANAGEMENT THROUGH VISION 2020, Pages: 4744-4751, 33rd International-Business-Information-Management-Association Conference, APR 10-11, 2019, Granada, SPAIN, ISBN: 978-0-9998551-2-6, Published: 2019;
102. Lupu, O., Zgripcea, L., Socalici, A., Popa, E., Harau, C. Pulverous ferrous waste processing by agglomeration, INTERNATIONAL CONFERENCE ON APPLIED SCIENCES, Book Series: IOP Conference Series-Materials Science and Engineering, Volume: 477, Article Number: 012007, International Conference on Applied Sciences (ICAS), MAY 09-11, 2018, Banja Luke, BOSNIA & HERCEG, ISSN: 1757-8981, Published: 2019;
103. Mamane, A., El Ghazi, M., Barb, G.R., Ottesteanu, M. 5G Heterogeneous Networks: An Overview on Radio Resource Management Scheduling Schemes, 2019 7TH MEDITERRANEAN CONGRESS OF TELECOMMUNICATIONS (CMT 2019), 7th Mediterranean Congress of Telecommunications (CMT), OCT 24-25, 2019, Fez, MOROCCO, ISBN: 978-1-7281-4420-7, Published: 2019;
104. Marinca, V., Herisanu, N. Optimal Homotopy Asymptotic Method for Polytrophic Spheres of the Lane-Emden type Equation, INTERNATIONAL CONFERENCE ON NUMERICAL ANALYSIS AND APPLIED MATHEMATICS (ICNAAM-2018), Book Series: AIP Conference Proceedings, Volume: 2116, Article Number: 300003, International Conference on Numerical Analysis and Applied Mathematics (ICNAAM), SEP 13-18, 2018, Rhodes, GREECE, ISSN: 0094-243X, ISBN: 978-0-7354-1854-7, Published: 2019;
105. Martin, A.D., Tutelea, L., Babau, R., Boldea, I. A novel approach to PLCs based systems utilized in electric drives, 2019 INTERNATIONAL AEGEAN CONFERENCE ON ELECTRICAL MACHINES AND POWER ELECTRONICS (ACEMP) & 2019 INTERNATIONAL CONFERENCE ON OPTIMIZATION OF ELECTRICAL AND ELECTRONIC EQUIPMENT (OPTIM), Pages: 77-84, International Aegean Conference on Electrical Machines and Power Electronics (ACEMP) / International Conference on Optimization of Electrical and Electronic Equipment (OPTIM), AUG 27-29, 2019, Istanbul, TURKEY, ISBN: 978-1-5386-7687-5, Published: 2019;

106. Mihancea, P.F., Scott, R. CodeSonar (R) Extension For Copy-Paste-(Mis)Adapt Error Detection, 2019 IEEE INTERNATIONAL CONFERENCE ON SOFTWARE MAINTENANCE AND EVOLUTION (ICSME 2019), Book Series: Proceedings-IEEE International Conference on Software Maintenance, Pages: 386-389, 35th IEEE International Conference on Software Maintenance and Evolution (ICSME), SEP 30-OCT 04, 2019, Cleveland, OH, ISSN: 1063-6773, ISBN: 978-1-7281-3094-1, Published: 2019;
107. Mihut, V.V., Baci, I., Panoiu, C., Panoiu, M. Hybrid power generator based on wind, hydro and solar for use as an alternative solution for power supply, INTERNATIONAL CONFERENCE ON APPLIED SCIENCES, Book Series: IOP Conference Series-Materials Science and Engineering, Volume: 477, Article Number: 012014, International Conference on Applied Sciences (ICAS), MAY 09-11, 2018, Banja Luke, BOSNIA & HERCEG, ISSN: 1757-8981, Published: 2019;
108. Mirsu, R., Simion, G., Căleanu, C.D., Ursulescu, O., Calimanu, I.P. Deep Neural Networks vs Bag of Features for Hand Gesture Recognition, 2019 42ND INTERNATIONAL CONFERENCE ON TELECOMMUNICATIONS AND SIGNAL PROCESSING (TSP), Pages: 369-372, 42nd International Conference on Telecommunications and Signal Processing (TSP), JUL 01-03, 2019, Budapest, HUNGARY, ISBN: 978-1-7281-1864-2, Published: 2019;
109. Mituletu, I.C., Bizau, V.I., Chioncel, C.P., Gillich, G.R. The Design of a Test Stand for the Shape Memory Alloys Control at High Current and Low Voltage, 2019 11TH INTERNATIONAL SYMPOSIUM ON ADVANCED TOPICS IN ELECTRICAL ENGINEERING (ATEE), Book Series: International Symposium on Advanced Topics in Electrical Engineering, 11th International Symposium on Advanced Topics in Electrical Engineering (ATEE), MAR 28-30, 2019, Bucharest, ROMANIA, ISSN: 1843-8571, ISBN: 978-1-4799-7514-3, Published: 2019;
110. Mohora, I., Anghel, A.A., Frigura-Iliasa, F.M. Smart solutions for adaptive workplaces. Architectural and technological applications, 2019 IEEE INTERNATIONAL CONFERENCE ON ENVIRONMENT AND ELECTRICAL ENGINEERING AND 2019 IEEE INDUSTRIAL AND COMMERCIAL POWER SYSTEMS EUROPE (EEEIC / I&CPS EUROPE), 19th IEEE International Conference on Environment and Electrical Engineering (EEEIC) / 3rd IEEE Industrial and Commercial Power Systems Europe Conference (I and CPS Europe), JUN 10-14, 2019, Genova, ITALY, ISBN: 978-1-7281-0652-6, Published: 2019;
111. Mohora, I., Anghel, A.A. Revitalization Proposals for Green Interior Courtyards in the Historical Centre of Timisoara, 3RD WORLD MULTIDISCIPLINARY CIVIL ENGINEERING, ARCHITECTURE, URBAN PLANNING SYMPOSIUM (WMCAUS 2018), Book Series: IOP Conference Series-Materials Science and Engineering, Volume: 471, Article Number: 082027, 3rd World Multidisciplinary Civil Engineering, Architecture, Urban Planning Symposium (WMCAUS), JUN 18-22, 2018, ISSN: 1757-8981, Published: 2019;
112. Mohora, I., Anghel, A.A. Urban Landscape- Cubic Stone Streets in Historical Areas, Advantages and Disadvantages, Case Study Timisoara Versus Rome, 3RD WORLD MULTIDISCIPLINARY CIVIL ENGINEERING, ARCHITECTURE, URBAN PLANNING SYMPOSIUM (WMCAUS 2018), Book Series: IOP Conference Series-Materials Science and Engineering, Volume: 471, Article Number: 082028, 3rd World Multidisciplinary Civil Engineering, Architecture, Urban Planning Symposium (WMCAUS), JUN 18-22, 2018, Prague, CZECH REPUBLIC, ISSN: 1757-8981, Published: 2019;
113. Mohora, I. OFFICE BUILDING LOCATION RELATED TO GREENERY TYPE CASE STUDY OF THE MAIN BUSINESS DISTRICTS IN PARIS, PROCEEDINGS OF INTCESS 2019- 6TH INTERNATIONAL CONFERENCE ON EDUCATION AND SOCIAL SCIENCES, Pages: 969-978, 6th International Conference on Education and Social Sciences (INTCESS), FEB 04-06, 2019, Dubai, U ARAB EMIRATES, ISBN: 978-605-82433-5-4, Published: 2019;
114. Mohora, I. IMPORTANCE OF BIOPHILIC ATTRIBUTES IN EUROPEAN COWORKING SPACES, PROCEEDINGS OF INTCESS 2019- 6TH INTERNATIONAL CONFERENCE ON EDUCATION AND SOCIAL SCIENCES, Pages: 979-988, 6th International Conference on Education and Social Sciences (INTCESS), FEB 04-06, 2019, Dubai, U ARAB EMIRATES, ISBN: 978-605-82433-5-4, Published: 2019;
115. Moscovici, A.M., Grecea, C., Vaduva, R. Redevelopment of Brownfield Sites: Case Study-Biled Village, Romania, 3RD WORLD MULTIDISCIPLINARY CIVIL ENGINEERING, ARCHITECTURE, URBAN PLANNING SYMPOSIUM (WMCAUS 2018), Book Series: IOP Conference Series-Materials Science and Engineering, Volume: 471, Article Number: 072032, 3rd World Multidisciplinary Civil Engineering, Architecture, Urban Planning Symposium (WMCAUS), JUN 18-22, 2018, Prague, CZECH REPUBLIC, ISSN: 1757-8981, Published: 2019;
116. Muntean, D.M., Ungureanu, V. Smart grid integration towards sustainable retrofitting of large prefabricated concrete panels collective housing built in the 1970s, LIFE-CYCLE ANALYSIS AND ASSESSMENT IN CIVIL ENGINEERING: TOWARDS AN INTEGRATED VISION, Pages: 3045-3050, 6th International Symposium on Life-Cycle Civil Engineering (IALCCE), OCT 28-31, 2018, Ghent, BELGIUM, ISBN: 978-1-315-22891-4; 978-1-138-62633-1, Published: 2019;

117. Muntean, G.A., Prostean, G. Technical Risk Analysis Model: Through Entire Supply Chain, EDUCATION EXCELLENCE AND INNOVATION MANAGEMENT THROUGH VISION 2020, Pages: 1965-1974, 33rd International-Business-Information-Management-Association Conference, APR 10-11, 2019, Granada, SPAIN, ISBN: 978-0-9998551-2-6, Published: 2019;
118. Muntean, S., Bosioc, A.I., Draghici, I.A., Anton, L.E. INVESTIGATION AND ANALYSIS OF THE FLOW FIELD INDUCED BY A SYMMETRICAL SUCTION ELBOW AT THE PUMP INLET, PROCEEDINGS OF THE ASME/JSME/KSME JOINT FLUIDS ENGINEERING CONFERENCE, 2019, VOL 3B, Book Series: ASME JSME KSME Joint Fluids Engineering Conference Proceedings, Article Number: V03BT03A024, ASME-JSME-KSME Joint Fluids Engineering Conference (AJK-FED 2019), JUL 28-AUG 01, 2019, San Francisco, CA, ISSN: 2333-2506, ISBN: 978-0-7918-5905-6, Published: 2019;
119. Murvay, P.S., Popa, L., Groza, B. Accommodating Time-Triggered Authentication to FlexRay Demands, THIRD CENTRAL EUROPEAN CYBERSECURITY CONFERENCE (CECC 2019), 3rd Central European Cybersecurity Conference (CECC), NOV 14-15, 2019, Munich, GERMANY, ISBN: 978-1-4503-7296-1, Published: 2019;
120. Nedelcu, D., Padurean, I., Bostan, A. The calculation of the Kaplan Turbine Hill Chart using the HydroHillChart software, INTERNATIONAL CONFERENCE ON APPLIED SCIENCES, Book Series: IOP Conference Series-Materials Science and Engineering, Volume: 477, Article Number: 012023, International Conference on Applied Sciences (ICAS), MAY 09-11, 2018, Banja Luke, BOSNIA & HERCEG, ISSN: 1757-8981, Published: 2019;
121. Nikolicic, S., Maslaric, M., Mircetic, D., Artene, A.E. TOWARDS MORE EFFICIENT LOGISTIC SOLUTIONS: SUPPLY CHAIN ANALYTICS, PROCEEDINGS OF THE 4TH LOGISTICS INTERNATIONAL CONFERENCE, Pages: 225-233, 4th Logistics International Conference (LOGIC), MAY 23-25, 2019, Belgrade, SERBIA, ISBN: 978-86-7395-402-8, Published: 2019;
122. Nunes, D.L., Ciutina, A. BEHAVIOUR OF END-PLATE STEEL CONNECTIONS WITH 4 BOLTS PER ROW UNDER LARGE DEFORMATIONS, PROCEEDINGS OF THE 9TH INTERNATIONAL CONFERENCE ON STEEL AND ALUMINIUM STRUCTURES (ICSAS19), Pages: 399-410, 9th International Conference on Steel and Aluminium Structures (ICSAS), JUL 03-05, 2019, Bradford, ENGLAND, ISBN: 978-1-78972-197-3, Published: 2019;
123. Olariu, A.F., Frigura-Iliasa, M., Dolga, L., Filipescu, H.E. A New Technical Solution for an Industrial 3D Safety Recognition System, 2019 IEEE 17TH WORLD SYMPOSIUM ON APPLIED MACHINE INTELLIGENCE AND INFORMATICS (SAMI 2019), Pages: 63-67, 17th IEEE World Symposium on Applied Machine Intelligence and Informatics (SAMI), JAN 24-26, 2019, Herlany, SLOVAKIA, ISBN: 978-1-7281-0250-4, Published: 2019;
124. Onescu, I., Mosoarca, M., Azap, B., Onescu, E. Seismic Losses Scenario for Cultural Promenade in Timisoara Capital of Culture 2021, Romania, 3RD WORLD MULTIDISCIPLINARY CIVIL ENGINEERING, ARCHITECTURE, URBAN PLANNING SYMPOSIUM (WMCAUS 2018), Book Series: IOP Conference Series-Materials Science and Engineering, Volume: 471, Article Number: 102041, 3rd World Multidisciplinary Civil Engineering, Architecture, Urban Planning Symposium (WMCAUS), JUN 18-22, 2018, Prague, CZECH REPUBLIC, ISSN: 1757-8981, Published: 2019;
125. Pater, F., Herban, S., Rosu, S. A Presentation of "Mathematical Optimization in Modern Medicine and Engineering" Symposium 2018, INTERNATIONAL CONFERENCE ON NUMERICAL ANALYSIS AND APPLIED MATHEMATICS (ICNAAM-2018), Book Series: AIP Conference Proceedings, Volume: 2116, Article Number: 370001, International Conference on Numerical Analysis and Applied Mathematics (ICNAAM), SEP 13-18, 2018, Rhodes, GREECE, ISSN: 0094-243X, ISBN: 978-0-7354-1854-7, Published: 2019;
126. Panoiu, M., Panoiu, C., Rusu-Anghel, S., Rob, R. Modeling the pantograph-catenary contact in electric railway transportation using Group Method of Data Handling, 45TH ANNUAL CONFERENCE OF THE IEEE INDUSTRIAL ELECTRONICS SOCIETY (IECON 2019), Book Series: IEEE Industrial Electronics Society, Pages: 3809-3814, 45th Annual Conference of the IEEE Industrial Electronics Society (IECON), OCT 14-17, 2019, Lisbon, PORTUGAL, ISSN: 1553-572X, ISBN: 978-1-7281-4878-6, Published: 2019;
127. Paun, A., Frigura-Iliasa, F.M., Dolga, L., Filipescu, H.E., Alexa, F., Anghel, A.A. DIDACTIC EMULATOR OF AN RDS CODER, 12TH INTERNATIONAL CONFERENCE OF EDUCATION, RESEARCH AND INNOVATION (ICERI 2019), Book Series: ICERI Proceedings, Pages: 2999-3005, 12th Annual International Conference of Education, Research and Innovation (ICERI), NOV 11-13, 2019, Seville, SPAIN, ISSN: 2340-1095, ISBN: 978-84-09-14755-7, Published: 2019;

128. Petre, C.A., Korodi, A. HoneyPot inside an OPC UA wrapper for water pumping stations, 2019 22ND INTERNATIONAL CONFERENCE ON CONTROL SYSTEMS AND COMPUTER SCIENCE (CSCS), Book Series: International Conference on Control Systems and Computer Science CSCS, Pages: 72-77, 22nd International Conference on Control Systems and Computer Science (CSCS), MAY 28-30, 2019, Bucharest, ROMANIA, ISSN: 2379-0474, eISSN: 2379-0482, ISBN: 978-1-7281-2331-8, Published: 2019;
129. Petrenci, R., Frigura-Iliasa, M., Frigura-Iliasa, F.M., Mirica, M., Dolga, L., Filipescu, H.E. CAD based design of a high energy absorption metal oxide varistor, 2018 11TH INTERNATIONAL CONFERENCE ON COMPUTER AND ELECTRICAL ENGINEERING, Book Series: Journal of Physics Conference Series, Volume: 1195, Article Number: 012024, 11th International Conference on Computer and Electrical Engineering (ICCEE), OCT 12-14, 2018, Tokyo, JAPAN, ISSN: 1742-6588, eISSN: 1742-6596, Published: 2019;
130. Petrenci, R.C., Frigura-Iliasa, M., Dolga, L., Filipescu, H.E. Digital Based Solutions for the Refurbishment of Existing Hydro-generators, 2019 IEEE 17TH WORLD SYMPOSIUM ON APPLIED MACHINE INTELLIGENCE AND INFORMATICS (SAMI 2019), Pages: 55-58, 17th IEEE World Symposium on Applied Machine Intelligence and Informatics (SAMI), JAN 24-26, 2019, Herlany, SLOVAKIA, ISBN: 978-1-7281-0250-4, Published: 2019;
131. Petrenci, R., Frigura-Iliasa, M., Frigura-Iliasa, F., Dolga, L., Filipescu, H.E., Vatau, D. Computer based Study about the Load Regime of a 40 MVA 110/6 kV Transformer, PROCEEDINGS OF THE 2019 20TH INTERNATIONAL SCIENTIFIC CONFERENCE ON ELECTRIC POWER ENGINEERING (EPE), Book Series: International Scientific Conference on Electric Power Engineering, Pages: 359-362, 20th International Scientific Conference on Electric Power Engineering (EPE), MAY 15-17, 2019, CZECH REPUBLIC, ISSN: 2376-5623, ISBN: 978-1-7281-1333-3, Published: 2019;
132. Pinca-Bretotean, C., Craciun, A.L., Josan, A., Ardelean, M. Friction and wear characteristic of organic brake pads material, INTERNATIONAL CONFERENCE ON APPLIED SCIENCES, Book Series: IOP Conference Series-Materials Science and Engineering, Volume: 477, Article Number: 012009, International Conference on Applied Sciences (ICAS), MAY 09-11, 2018, Banja Luke, BOSNIA & HERCEG, ISSN: 1757-8981, Published: 2019;
133. Pop, M.D., Prostean, O. Identification of significant metrics and indicators for smart mobility, INTERNATIONAL CONFERENCE ON APPLIED SCIENCES, Book Series: IOP Conference Series-Materials Science and Engineering, Volume: 477, Article Number: 012017, International Conference on Applied Sciences (ICAS), MAY 09-11, 2018, Banja Luke, BOSNIA & HERCEG, ISSN: 1757-8981, Published: 2019;
134. Pop, M.D., Prostean, O. Bayesian Reasoning for OD Volumes Estimation in Absorbing Markov Traffic Process Modeling, 2019 4TH MEC INTERNATIONAL CONFERENCE ON BIG DATA AND SMART CITY (ICBDSC), Pages: 8-13, 4th MEC International Conference on Big Data and Smart City (ICBDSC), JAN 15-16, 2019, Muscat, OMAN, ISBN: 978-1-5386-8046-9, Published: 2019;
135. Popa, G.N., Dinis, C.M., Iagar, A., Deaconu, S.I. Study on a maximum power point tracking controller for photovoltaic panels, INTERNATIONAL CONFERENCE ON APPLIED SCIENCES, Book Series: IOP Conference Series-Materials Science and Engineering, Volume: 477, Article Number: 012030, International Conference on Applied Sciences (ICAS), MAY 09-11, 2018, Banja Luke, BOSNIA & HERCEG, ISSN: 1757-8981, Published: 2019;
136. Popa, G.N., Dinis, C.M., Iagar, A., Lolea, M. The Power Quality at an Electrical Power Station of the Hospital, 2019 11TH INTERNATIONAL SYMPOSIUM ON ADVANCED TOPICS IN ELECTRICAL ENGINEERING (ATEE), Book Series: International Symposium on Advanced Topics in Electrical Engineering, 11th International Symposium on Advanced Topics in Electrical Engineering (ATEE), MAR 28-30, 2019, Bucharest, ROMANIA, ISSN: 1843-8571, ISBN: 978-1-4799-7514-3, Published: 2019;
137. Popescu, A., Frigura-Iliasa, F.M., Iorga, M., Frigura-Iliasa, M. Computer Based Model for an Off-Grid Photovoltaic System with no DC - DC Adapter, 2019 IEEE 17TH WORLD SYMPOSIUM ON APPLIED MACHINE INTELLIGENCE AND INFORMATICS (SAMI 2019), Pages: 381-384, 17th IEEE World Symposium on Applied Machine Intelligence and Informatics (SAMI), JAN 24-26, 2019, Herlany, SLOVAKIA, ISBN: 978-1-7281-0250-4, Published: 2019;
138. Popescu, A., Lazarescu, E., Frigura-Iliasa, F.M., Dolga, L., Filipescu, H.E., Anghel, A. Analytical Model for the Electrodynamical Forces inside Electrical Contacts of Commutation Devices, PROCEEDINGS OF THE 2019 20TH INTERNATIONAL SCIENTIFIC CONFERENCE ON ELECTRIC POWER ENGINEERING (EPE), Book Series: International Scientific Conference on Electric Power Engineering, Pages: 283-286, 20th International Scientific Conference on Electric Power Engineering (EPE), MAY 15-17, 2019, CZECH REPUBLIC, ISSN: 2376-5623, ISBN: 978-1-7281-1333-3, Published: 2019;

139. Popescu, T.M., Popescu, A.M., Prostean, G., Popescu, D.E. Evaluation of Legislations from the Perspective of Organizational Understanding to Managing Cybersecurity Risk, EDUCATION EXCELLENCE AND INNOVATION MANAGEMENT THROUGH VISION 2020, Pages: 4677-4689, 33rd International-Business-Information-Management-Association Conference, APR 10-11, 2019, Granada, SPAIN, ISBN: 978-0-9998551-2-6, Published: 2019;
140. Popescu-Busan, A.I., Ilinca, C., Nicoara, S.V., Constantin, A.T., Anghel, C.G. Breach Forming Scenarios at Concrete Faced Rock-fill Dams, 3RD WORLD MULTIDISCIPLINARY CIVIL ENGINEERING, ARCHITECTURE, URBAN PLANNING SYMPOSIUM (WMCAUS 2018), Book Series: IOP Conference Series-Materials Science and Engineering, Volume: 471, Article Number: 102049, 3rd World Multidisciplinary Civil Engineering, Architecture, Urban Planning Symposium (WMCAUS), JUN 18-22, 2018, Prague, CZECH REPUBLIC, ISSN: 1757-8981, Published: 2019;
141. Precup, R.E., Teban, T.A., Albu, A., Borlea, A.B., Zamfirache, I.A., Petriu, E.M. Evolving Fuzzy Models for Prosthetic Hand Myoelectric-based Control Using Weighted Recursive Least Squares Algorithm for Identification, 2019 IEEE INTERNATIONAL SYMPOSIUM ON ROBOTIC AND SENSORS ENVIRONMENTS (ROSE 2019), Pages: 164-169, IEEE International Symposium on Robotic and Sensors Environments (ROSE), JUN 17-18, 2019, Ottawa, CANADA, ISBN: 978-1-7281-1964-9, Published: 2019;
142. Prodan, G. Inventory Optimization Using Lean Six-Sigma, EDUCATION EXCELLENCE AND INNOVATION MANAGEMENT THROUGH VISION 2020, Pages: 2186-2198, 33rd International-Business-Information-Management-Association Conference, APR 10-11, 2019, Granada, SPAIN, ISBN: 978-0-9998551-2-6, Published: 2019;
143. Ricman, R.S., Szabo, R., Gontean, A. The Creation of a Free Vocal SMS and Email Sender and Reader App with Chat Style Interface, PROCEEDINGS OF THE 2019 10TH IEEE INTERNATIONAL CONFERENCE ON INTELLIGENT DATA ACQUISITION AND ADVANCED COMPUTING SYSTEMS - TECHNOLOGY AND APPLICATIONS (IDAACS), VOL. 2, Book Series: IEEE International Workshop on Intelligent Data Acquisition and Advanced Computing Systems-Technology and Applications-IDAACS, Pages: 761-764, 10th IEEE International Conference on Intelligent Data Acquisition and Advanced Computing Systems - Technology and Applications (IDAACS), SEP 18-21, 2019, Metz, FRANCE, ISBN: 978-1-7281-4068-1, Published: 2019;
144. Riemschneider, E., Bundau, O., Juratoni, A., Pater, F. An Existence Result for the Control Problem Associated to an Economical Growth Model, INTERNATIONAL CONFERENCE ON NUMERICAL ANALYSIS AND APPLIED MATHEMATICS (ICNAAM-2018), Book Series: AIP Conference Proceedings, Volume: 2116, Article Number: 370007, International Conference on Numerical Analysis and Applied Mathematics (ICNAAM), SEP 13-18, 2018, Rhodes, GREECE, ISSN: 0094-243X, ISBN: 978-0-7354-1854-7, Published: 2019;
145. Rob, R., Panoiu, C. Using LabVIEW Linx for Creating 3d Objects, INTERNATIONAL CONFERENCE ON APPLIED SCIENCES, Book Series: IOP Conference Series-Materials Science and Engineering, Volume: 477, Article Number: 012027, International Conference on Applied Sciences (ICAS), MAY 09-11, 2018, Banja Luke, BOSNIA & HERCEG, ISSN: 1757-8981, Published: 2019;
146. Roman, R.C., Precup, R.E., Petriu, E.M., Hedrea, E.L., Bojan-Dragos, C.A., Radac, M.B. Model-Free Adaptive Control With Fuzzy Component for Tower Crane Systems, 2019 IEEE INTERNATIONAL CONFERENCE ON SYSTEMS, MAN AND CYBERNETICS (SMC), Book Series: IEEE International Conference on Systems Man and Cybernetics Conference Proceedings, Pages: 1384-1389, IEEE International Conference on Systems, Man and Cybernetics (SMC), OCT 06-09, 2019, Bari, ITALY, ISSN: 1062-922X, ISBN: 978-1-7281-4569-3, Published: 2019;
147. Roman, R.C., Precup, R.E., Bojan-Dragos, C.A., Szedlak-Stinean, A.I. Combined Model-Free Adaptive Control with Fuzzy Component by Virtual Reference Feedback Tuning for Tower Crane Systems, 7TH INTERNATIONAL CONFERENCE ON INFORMATION TECHNOLOGY AND QUANTITATIVE MANAGEMENT (ITQM 2019): INFORMATION TECHNOLOGY AND QUANTITATIVE MANAGEMENT BASED ON ARTIFICIAL INTELLIGENCE, Book Series: Procedia Computer Science, Volume: 162, Pages: 267-274, 7th International Conference on Information Technology and Quantitative Management (ITQM) - Information Technology and Quantitative Management Based on Artificial Intelligence, NOV 03-06, 2019, Granada, SPAIN, ISSN: 1877-0509, Published: 2019;
148. Serban, E., Ordenez, M., Pondiche, C., Hulea, D. Voltage and Power Balancing in Solar and Energy Storage Converters, 2019 IEEE ENERGY CONVERSION CONGRESS AND EXPOSITION (ECCE), Book Series: IEEE Energy Conversion Congress and Exposition ,Pages: 5832-5839, 11th Annual IEEE Energy Conversion Congress and Exposition (ECCE), SEP 29-OCT 03, 2019, Baltimore, MD, ISSN: 2329-3721, ISBN: 978-1-7281-0395-2, Published: 2019;

149. Serban, E., Pondiche, C., Serban, H., Lascu, C., Cornea, O. DC Voltage Control Architecture in Renewable Energy Based Three-Level Converters, THIRTY-FOURTH ANNUAL IEEE APPLIED POWER ELECTRONICS CONFERENCE AND EXPOSITION (APEC 2019), Book Series: Annual IEEE Applied Power Electronics Conference and Exposition (APEC), Pages: 1949-1956, 34th Annual IEEE Applied Power Electronics Conference and Exposition (APEC), MAR 17-21, 2019, Anaheim, CA, ISSN: 1048-2334, ISBN: 978-1-5386-8330-9, Published: 2019;
150. Serban, M.C., Serban, A., Ursoniu, S., Dragan, S. SYSTEMATIC REVIEW ON THE POTENTIAL OF SEA BUCKTHORN HIPPOPHAE RHAMNOIDES L. FOR A POSSIBLE NOVEL ENRICHED BREAD FOR THE PATIENTS WITH CARDIOVASCULAR DISEASES, ATHEROSCLEROSIS, Meeting Abstract: EAS19-1140, Volume: 287, Pages: E285-E285, 87th Congress of the European-Atherosclerosis-Society (EAS), MAY 26-29, 2019, Maastricht, NETHERLANDS, ISSN: 0021-9150, eISSN: 1879-1484, Published: 2019;
151. Silaghi, A.M., Pacurar, O., De Sabata, A. Investigations on Repeatability of Radiated Emissions Testing for Frequencies below 30 MHz, 2019 INTERNATIONAL SYMPOSIUM ON SIGNALS, CIRCUITS AND SYSTEMS (ISSCS 2019), 14th International Symposium on Signals, Circuits and Systems (ISSCS), JUL 11-12, 2019, Iasi, ROMANIA, ISBN: 978-1-7281-3896-1, Published: 2019;
152. Sinoi, A.C., Udrescu, M., Topirceanu, A., Rus, A., Mihaicuta, S.A. SAS score, STOP-Bang and NoSAS - targeting high-specificity for population-wide monitoring of obstructive sleep apnea, EUROPEAN RESPIRATORY JOURNAL, Meeting Abstract: PA840, Volume: 54, European-Respiratory-Society (ERS) International Congress, SEP 28-OCT 02, 2019, Madrid, SPAIN, ISSN: 0903-1936, eISSN: 1399-3003, Published: 2019;
153. Stoia, D.I., Marsavina, L. Effect of Aluminum Particles on the Fracture Toughness of Polyamide-based Parts Obtained by Selective Laser Sintering (SLS), 25TH INTERNATIONAL CONFERENCE ON FRACTURE AND STRUCTURAL INTEGRITY, Book Series: Procedia Structural Integrity, Volume: 18, Pages: 163-169, 25th International Conference on Fracture and Structural Integrity, JUN 12-14, 2019, Catania, ITALY, ISSN: 2452-3216, Published: 2019;
154. Stoica, V., Ilie, M., Borborean, A., Cioabla, A., Lelea, D. Experimental test bench for studying the boiling dynamics, INTERNATIONAL CONFERENCE ON APPLIED SCIENCES, Book Series: IOP Conference Series-Materials Science and Engineering, Volume: 477, Article Number: 012047, International Conference on Applied Sciences (ICAS), MAY 09-11, 2018, Banja Luke, BOSNIA & HERCEG, ISSN: 1757-8981, Published: 2019;
155. Stoica, V., Trif-Tordai, G., Ilie, M., Calinoiu, D. Flash boiling steam engine, INTERNATIONAL CONFERENCE ON APPLIED SCIENCES, Book Series: IOP Conference Series-Materials Science and Engineering, Volume: 477, Article Number: 012048, International Conference on Applied Sciences (ICAS), MAY 09-11, 2018, Banja Luke, BOSNIA & HERCEG, ISSN: 1757-8981, Published: 2019;
156. Swart, A.J., Daneti, M. Analyzing Learning Outcomes for Electronic Fundamentals Using Bloom's Taxonomy, PROCEEDINGS OF 2019 IEEE GLOBAL ENGINEERING EDUCATION CONFERENCE (EDUCON), Book Series: IEEE Global Engineering Education Conference, Pages: 39-44, 10th IEEE Global Engineering Education Conference (EDUCON), APR 09-11, 2019, Dubai, U ARAB EMIRATES, ISSN: 2165-9567, ISBN: 978-1-5386-9506-7, Published: 2019;
157. Tamasila, M., Ivascu, L., Turi, A., Artene, A. Evaluation the Importance of ISO Standard Management for Sustainable Development in the Circular Economy Context, EDUCATION EXCELLENCE AND INNOVATION MANAGEMENT THROUGH VISION 2020, Pages: 5317-5325, 33rd International-Business-Information-Management-Association (IBIMA) Conference, APR 10-11, 2019, Granada, SPAIN, ISBN: 978-0-9998551-2-6, Published: 2019;
158. Tanasa, C., Stoian, V., Stoian, D., Dan, D. Energy consumption evaluation of a passive house through numerical simulations and monitoring data, LIFE-CYCLE ANALYSIS AND ASSESSMENT IN CIVIL ENGINEERING: TOWARDS AN INTEGRATED VISION, Pages: 3017-3022, 6th International Symposium on Life-Cycle Civil Engineering (IALCCE), OCT 28-31, 2018, Ghent, BELGIUM, ISBN: 978-1-315-22891-4; 978-1-138-62633-1, Published: 2019;
159. Tej, M.L., Holban, S. Determining Optimal Multi-layer Perceptron Structure Using Linear Regression, BUSINESS INFORMATION SYSTEMS, PT I, Book Series: Lecture Notes in Business Information Processing, Volume: 353, Pages: 232-246, 22nd International Conference on Business Information Systems (BIS), JUN 26-28, 2019, Seville, SPAIN, ISSN: 1865-1348, ISBN: 978-3-030-20485-3; 978-3-030-20484-6, Published: 2019;

160. Todor, M.P., Bulei, C., Kiss, I., Alexa, V. Recycling of textile wastes into textile composites based on natural fibres: the valorisation potential, INTERNATIONAL CONFERENCE ON APPLIED SCIENCES, Book Series: IOP Conference Series–Materials Science and Engineering, Volume: 477, Article Number: 012004, International Conference on Applied Sciences (ICAS), MAY 09-11, 2018, Banja Luke, BOSNIA & HERCEG, ISSN: 1757-8981, Published: 2019;
161. Todor, M.P., Bulei, C., Kiss, I., Cioata, V.G. Recycling of textile wastes into textile composites based on natural fibres: the reinforcement type and the architecture, INTERNATIONAL CONFERENCE ON APPLIED SCIENCES, Book Series: IOP Conference Series–Materials Science and Engineering, Volume: 477, Article Number: 012055, International Conference on Applied Sciences (ICAS), MAY 09-11, 2018, Banja Luke, BOSNIA & HERCEG, ISSN: 1757-8981, Published: 2019;
162. Tokar, D., Foris, D., Tokar, A., Foris, T. SUSTAINABLE DEVELOPMENT OF DISADVANTAGED REGIONS BY RENEWABLE ENERGY SOURCES INTEGRATION, ECONOMIC SCIENCE FOR RURAL DEVELOPMENT 2019, Book Series: Economic Science for Rural Development, Volume: 51, Pages: 237-244, 20th International Scientific Conference on Economic Science for Rural Development (ESRD), MAY 09-10, 2019, Jelgava, LATVIA, ISSN: 1691-3078, eISSN: 2255-9930, ISBN: 978-9984-48-321-4, Published: 2019;
163. Totorean, A.F., Totorean, I.C., Bernad, S.I. Local vs. Global Parameters in Case of Grid-Sensitivity Study for Computational Fluid Dynamics with Application in Bypass Hemodynamics, INTERNATIONAL CONFERENCE ON NUMERICAL ANALYSIS AND APPLIED MATHEMATICS (ICNAAM-2018), Book Series: AIP Conference Proceedings, Volume: 2116, Article Number: 030032, International Conference on Numerical Analysis and Applied Mathematics (ICNAAM), SEP 13-18, 2018, Rhodes, GREECE, ISSN: 0094-243X, ISBN: 978-0-7354-1854-7, Published: 2019;
164. Totorean, A.F., Hudrea, I.C. Local Hemodynamics in Coronary Bypass in the Presence of Competitive Flow and Different Diameter Ratios Between Graft and Host Artery, WORLD CONGRESS ON MEDICAL PHYSICS AND BIOMEDICAL ENGINEERING 2018, VOL 1, Book Series: IFMBE Proceedings, Volume: 68, Issue: 1, Pages: 767-771, IUPESM World Congress on Medical Physics and Biomedical Engineering, JUN 03-08, 2018, Prague, CZECH REPUBLIC, ISSN: 1680-0737, ISBN: 978-981-10-9035-6; 978-981-10-9034-9, Published: 2019;
165. Totorean, I.C., Totorean, A.F., Bernad, S.I., Gaita, D. Flow Field Alterations in Case of Coronary Stent Malapposition - a Computational Fluid Dynamics Study, INTERNATIONAL CONFERENCE ON NUMERICAL ANALYSIS AND APPLIED MATHEMATICS (ICNAAM-2018), Book Series: AIP Conference Proceedings, Volume: 2116, Article Number: 030023, International Conference on Numerical Analysis and Applied Mathematics (ICNAAM), SEP 13-18, 2018, Rhodes, GREECE, ISSN: 0094-243X, ISBN: 978-0-7354-1854-7, Published: 2019;
166. Tucu, D., Crisan, G.C., Tucu, A. THE USE OF SELF-ASSESSMENT IN OCCUPATIONAL RISK MANAGEMENT SYSTEM IN SMES FROM AGRICULTURE, AKTUALNI ZADACI MEHANIZACIJE POLJOPRIVREDE: ZBORNIK RADOVA: ACTUAL TASKS ON AGRICULTURAL ENGINEERING. PROCEEDINGS, Book Series: Actual Tasks on Agricultural Engineering-Zagreb, Volume: 47, Pages: 479-485, 47th Symposium on Actual Tasks on Agricultural Engineering, MAR 05-07, 2019, Opatija, CROATIA, ISSN: 1848-4425, Published: 2019;
167. Tudor, C.M., Rogobete, G., Grozav, A. Rheological Behaviour in a Clayey Soils, 3RD WORLD MULTIDISCIPLINARY CIVIL ENGINEERING, ARCHITECTURE, URBAN PLANNING SYMPOSIUM (WMCAUS 2018), Book Series: IOP Conference Series–Materials Science and Engineering, Volume: 471, Article Number: 042014, 3rd World Multidisciplinary Civil Engineering, Architecture, Urban Planning Symposium (WMCAUS), JUN 18-22, 2018, Prague, CZECH REPUBLIC, ISSN: 1757-8981, Published: 2019;
168. Turi, A., Mocan, M., Goncalves, G., Ivascu, L. Production Organization and Logistics Effectiveness in Automotive Industry – Dacia-Renault Case Study, EDUCATION EXCELLENCE AND INNOVATION MANAGEMENT THROUGH VISION 2020, Pages: 646-656, 33rd International-Business-Information-Management-Association Conference, APR 10-11, 2019, Granada, SPAIN, ISBN: 978-0-9998551-2-6, Published: 2019;
169. Turi, A., Mocan, M., Goncalves, G., Ivascu, L. Supply Chain Management in Automotive Industry: Comparative Analysis of Dacia and Renault Brands, EDUCATION EXCELLENCE AND INNOVATION MANAGEMENT THROUGH VISION 2020, Pages: 4081-4091, 33rd International-Business-Information-Management-Association (IBIMA) Conference, APR 10-11, 2019, Granada, SPAIN, ISBN: 978-0-9998551-2-6, Published: 2019;
170. Ungureanu, V., Muntean, D.M. Life Cycle Assessment of Retrofitting Large Prefabricated Panels Low-Rise Collective Dwellings, 3RD WORLD MULTIDISCIPLINARY CIVIL ENGINEERING, ARCHITECTURE, URBAN PLANNING SYMPOSIUM (WMCAUS 2018), Book Series: IOP Conference Series–Materials Science and Engineering, Volume: 471, Article Number: 112070, 3rd World Multidisciplinary Civil Engineering, Architecture, Urban Planning Symposium (WMCAUS), JUN 18-22, 2018, Prague, CZECH REPUBLIC, ISSN: 1757-8981, Published: 2019;

171. Ungureanu, V.I., Trutiu, B.A., Silea, I., Negirla, P., Zimbru, C., Miclea, R.C. Automatic mapping of a room using LIDAR-based measuring sensor, 2019 22ND INTERNATIONAL CONFERENCE ON CONTROL SYSTEMS AND COMPUTER SCIENCE (CSCS), Book Series: International Conference on Control Systems and Computer Science CSCS, Pages: 689-695, 22nd International Conference on Control Systems and Computer Science (CSCS), MAY 28-30, 2019, Bucharest, ROMANIA, ISSN: 2379-0474, eISSN: 2379-0482, ISBN: 978-1-7281-2331-8, Published: 2019;
172. Vares, S., Hradil, P., Pulakka, S., Ungureanu, V., Sansom, M. Environmental- and life cycle cost impact of reused steel structures: A case study, LIFE-CYCLE ANALYSIS AND ASSESSMENT IN CIVIL ENGINEERING: TOWARDS AN INTEGRATED VISION, Pages: 2443-2449, 6th International Symposium on Life-Cycle Civil Engineering (IALCCE), OCT 28-31, 2018, Ghent, BELGIUM, ISBN: 978-1-315-22891-4; 978-1-138-62633-1, Published: 2019;
173. Vartolomei, M. Social Responsibility in Knowledge Management for Sustainable Eco-Economy, EDUCATION EXCELLENCE AND INNOVATION MANAGEMENT THROUGH VISION 2020, Pages: 8260-8269, 33rd International-Business-Information-Management-Association (IBIMA) Conference, APR 10-11, 2019, Granada, SPAIN, ISBN: 978-0-9998551-2-6, Published: 2019;
174. Vataman, A., Ciutina, A., Grecea, D. INFLUENCE OF DETAILING OF SHORT LINKS ON THE SEISMIC RESPONSE OF COMPOSITE ECCENTRICALLY BRACED FRAMES, PROCEEDINGS OF THE 9TH INTERNATIONAL CONFERENCE ON STEEL AND ALUMINIUM STRUCTURES (ICSAS19), Pages: 1218-1229, 9th International Conference on Steel and Aluminium Structures (ICSAS), JUL 03-05, 2019, Bradford, ENGLAND, ISBN: 978-1-78972-197-3, Published: 2019;
175. Vinga, C.M., Pfeifer, F., Filipescu, H.E., Todea, N., Frigura-Iliasa, F.M., Iorga, M. DIDACTIC PROCEDURE AND EQUIPMENT FOR THE STUDY OF LOW VOLTAGE POWER QUALITY PARAMETERS, 12TH INTERNATIONAL CONFERENCE OF EDUCATION, RESEARCH AND INNOVATION (IC-ERI2019), Book Series: ICERI Proceedings, Pages: 7419-7425, 12th Annual International Conference of Education, Research and Innovation (ICERI), NOV 11-13, 2019, Seville, SPAIN, ISSN: 2340-1095, ISBN: 978-84-09-14755-7, Published: 2019;
176. Vitan, L.D., Tutelea, L., Muntean, N., Boldea, I. Sensorless Synchronous Reluctance Generator Control Based on q Axis Estimated Current, 2019 INTERNATIONAL AEGEAN CONFERENCE ON ELECTRICAL MACHINES AND POWER ELECTRONICS (ACEMP) & 2019 INTERNATIONAL CONFERENCE ON OPTIMIZATION OF ELECTRICAL AND ELECTRONIC EQUIPMENT (OPTIM), Pages: 260-267, International Aegean Conference on Electrical Machines and Power Electronics (ACEMP) / International Conference on Optimization of Electrical and Electronic Equipment (OPTIM), AUG 27-29, 2019, Istanbul, TURKEY, ISBN: 978-1-5386-7687-5, Published: 2019;
177. Vulcu, C., Don, R., Ciutina, A. BEAM-TO-COLUMN JOINTS FOR SLIM-FLOOR SYSTEMS IN SEISMIC ZONES, PROCEEDINGS OF THE 9TH INTERNATIONAL CONFERENCE ON STEEL AND ALUMINIUM STRUCTURES (ICSAS19), Pages: 1158-1169, 9th International Conference on Steel and Aluminium Structures (ICSAS), JUL 03-05, 2019, Bradford, ENGLAND, ISBN: 978-1-78972-197-3, Published: 2019;
178. Vutan, A.M., Gruescu, C.M., Ciupe, V., Margineanu, D., Lovasz, E.C. Effectiveness of Physical Exercises in the Treatment of Scoliosis - Mathematical Approach, NEW TRENDS IN MEDICAL AND SERVICE ROBOTICS: ADVANCES IN THEORY AND PRACTICE, Book Series: Mechanisms and Machine Science, Volume: 65 Pages: 25-34, 6th International Workshop on Medical and Service Robots (MESROB), 2018, Cassino, ITALY, ISSN: 2211-0984, eISSN: 2211-0992, ISBN: 978-3-030-00329-6; 978-3-030-00328-9, Published: 2019;
179. Zamfira, A. An Object-Oriented Reasoner for Saturation of Logical Knowledge Bases, NEW TECHNOLOGIES AND REDESIGNING LEARNING SPACES, VOL I, Book Series: eLearning and Software for Education, Pages: 444-451, 15th International Scientific Conference on eLearning and Software for Education (eLSE) - New Technologies and Redesigning Learning Spaces, APR 11-12, 2019, Bucharest, ROMANIA, ISSN: 2066-026X, Published: 2019;
180. Zgripcea, L., Lupu, O., Putan, V., Birtok-Baneasa, C. Researches for improving mechanical characteristics of high strength weld, INTERNATIONAL CONFERENCE ON APPLIED SCIENCES, Book Series: IOP Conference Series-Materials Science and Engineering, Volume: 477, Article Number: 012008, International Conference on Applied Sciences (ICAS), MAY 09-11, 2018, Banja Luke, BOSNIA & HERCEG, ISSN: 1757-8981, Published: 2019.

*The data was obtained from Web of Science - Clarivate Analytics in 22 June 2020

BOOKS

EVOLUTION OF BOOKS UNDER AFFILIATIONS OF UPT 2015 - 2019

A published book is indisputable evidence of research that has been performed, completed, and accepted by peers. Book is also an indicator of achievement of a certain academic standard. Besides communication of a finalised piece of research, the book is the basis for further opinions, views and critiques from fellow professionals and academics separated by time and distance. Most importantly, it represents the only permanent record of scientific work that has been completed.

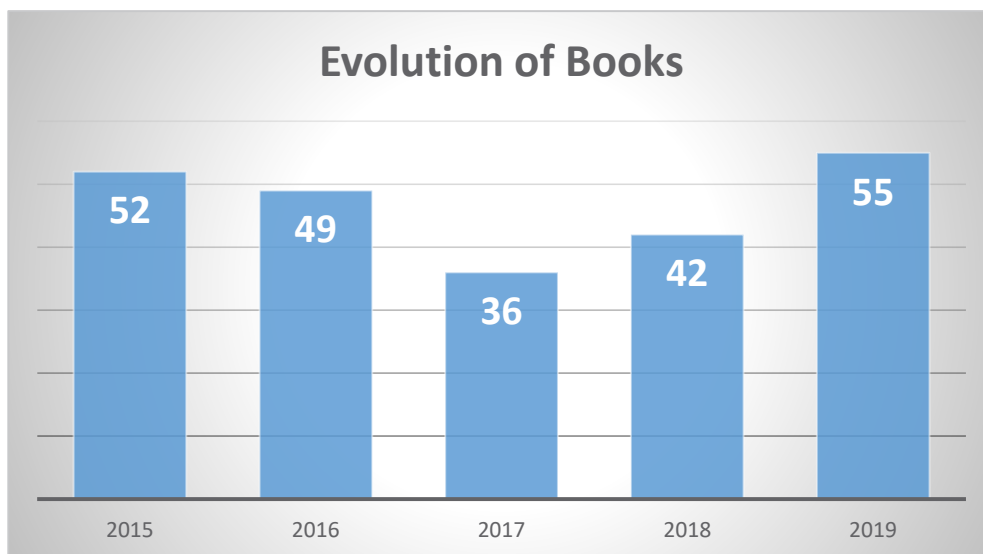

In this chapter we present the books written by our professors and researchers, published at Romanian publishers as well as at international prestigious publishers.

Politehnica University Timisoara
1989-2019
100 Scientific Books in Highlight

POLITEHNICA UNIVERSITY TIMIȘOARA, 1989 - 2019: 100 SCIENTIFIC BOOKS IN HIGHLIGHT

Daniel DEJICA-CARȚIȘ, Editor
Editura Politehnica, Timișoara, 2019
ISBN 978-606-35-0319-1

Message from the Rector

In 2018 we celebrated the Centenary of Romania, in 2019 the Centenary of Banat, and in 2020 we celebrate the Centenary of the Timișoara Polytechnic. It is interesting how history sometimes fits things in and ties them together. In the same way in which the Banatians' desire to have a higher education institute would not have been possible in the absence of the Great Union, the Polytechnic School could not have been created without the union of the Banat region with the Motherland. The emulation that led to the establishment of the Polytechnic School by the royal decree signed by His Majesty King Ferdinand on November 11, 1920, raised Timișoara to the rank of Civitas Academica. In return, Politehnica, in its own mission, has contributed in an exemplary way to the economic, social and cultural development of Timișoara, Banat, Romania and even beyond these borders.

If at the beginning - as the Rector of the time, Victor Vălcovici, would declare at the institution's 10th anniversary - "Politehnica was like a new born baby ... almost everything was missing", now, the Politehnica University Timișoara, the oldest institution of higher education in the western part of Romania, is included in the category of the most valuable institutions of higher education in the country, that of universities of advanced research and education.

Today, we are proud that more than 130,000 graduates have carried on the spirit of the Polytechnic and have had a remarkable contribution to the economic development of Romania and beyond, the quality of the engineers trained in Timișoara being a respected and appreciated business card anywhere in world.

In addition, the Polytechnic School of Timișoara is recognized as a powerful center for research, technological transfer and innovation. The excellent results materialized by the hundreds of grants and scientific contracts obtained in various fields of advanced and applied research, the internationalization of the research activity by

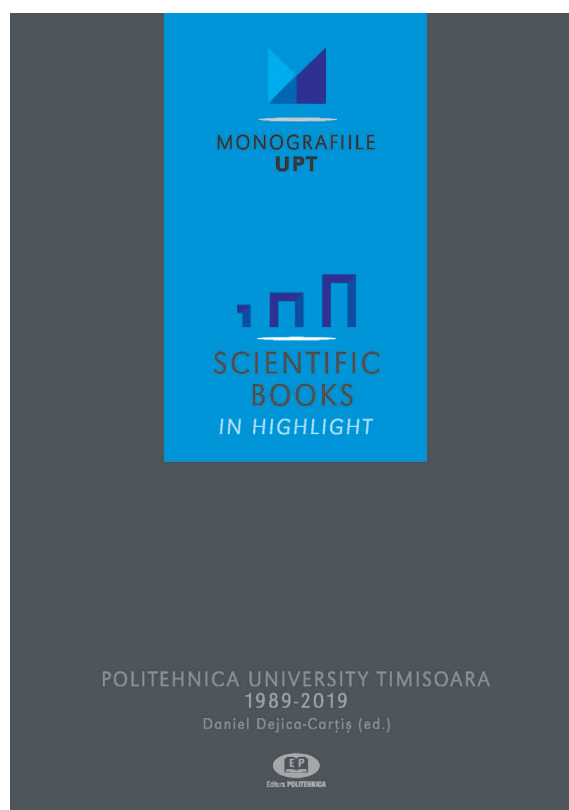

participating in research networks or consortia, the increased degree of valorisation of the research results carried out by publishing in prestigious ISI journals, are undeniable examples of the activity of excellence carried out here.

The reputation that our university enjoys in this area is also highlighted by the position on the leading places in international rankings (for example, SCImago Rankings 2018 place us in the third position at national level, and in the 47th place among more than 3,000 universities in Central Europe).

The present editorial project, dedicated to the Centenary of our university, supports the aforementioned by reflecting the results of the scientific activities of the teaching staff, published in monographs or specialized volumes at prestigious publishers from abroad, the Publishing House of the Romanian Academy or the Technical Publishing House in the last 30 years.

I am convinced that the 100 books summarized in this monograph, in addition to the recognition of their authors, will also contribute to strengthening the prestige of the institution at international level and will facilitate the internationalization of scientific research and cooperation by establishing new links or strengthening existing ones with universities and research institutes around the world.

Prof. univ. dr. eng. Viorel-Aurel Șerban,
Rector of the Politehnica University Timișoara

A Message from the Editor: Celebrating Academic Excellence

The edited volume **Politehnica University Timișoara, 1989-2019: 100 Scientific Books in Highlight** is part of an extensive editorial project and book series aimed at celebrating the 100th anniversary of our institution. It includes a part of the books published by the members of the Politehnica academic community at international publishing houses or in Romania, at Editura Academiei Române [The Publishing House of the Romanian Academy] and Editura Tehnică [Technical Publishing House] in the above-mentioned period.

A centennial offers a good reason to analyze the past and look into the future. In particular, such an editorial project highlights multiple results and puts forward several objectives: the monograph reconfirms our status of advanced research and education university, reflects the research interests of the teachers in the various scientific branches of our university, can be a valuable source of reference for teachers but also for the students enrolled in the university master's or PhD programs, may stimulate further research activities and publication projects by the younger generation, and last but not least, can be act like a genuine business card for our colleagues from the universities in Romania and abroad, increasing thus the collaboration opportunities the degree of visibility and internationalization of our institution.

Editing such a monograph was a challenging endeavour, given the diversity of scientific interests of the colleagues from the research centers or departments of the university, and the different time intervals when these scientific research results were materialized by the publication of the books. The major criterion underlying the arrangement of the books in the monograph was the existing classification in the Nomenclature of the fields and specializations / programs of university studies. Within the same branch of science, the arrangement was made chronologically.

The books were thus grouped under four major fundamental domains, including engineering sciences, mathematics and natural sciences, social sciences, humanities and arts. These domains were subsequently grouped under the various existing branches of science at our university.

Engineering sciences, the largest book section, includes 77 contributions grouped under four branches of science: civil engineering; electrical engineering, electronics and telecommunications; systems engineering, computers and information technology; and mechanical engineering, mechatronics, industrial engineering.

The remaining 23 contributions are shared by mathematics and natural sciences, social sciences, humanities and the arts. Accordingly, the 7 contributions included in the mathematics and natural sciences section are shared by mathematics (2) and chemistry (5); the social sciences section includes 5 contributions in the fields of administrative sciences and economics; and last but not least, 11 contributions are included in the humanities and arts section, of which, philology (10) and architecture (1).

12 out of the 100 contributions were published in Romania by Editura Academiei Române (6) and by Editura Tehnică (6). The majority of the books published abroad include those published by prestigious publishing houses such as Springer (16) or Elsevier (5), and also by many other famous publishing houses such as Cambridge Scholars Publishing, CRC Press, DeGruyter, Imperial College Press, Kluwer Academic Publishers, Royal Society of Chemistry or Taylor & Francis, to name just a few. Out of the 100 contributions, 75 are authored or edited books, while 25 are book chapters signed by our colleagues and included in collective volumes edited by international authors.

In a nutshell, this edited monograph is intended to celebrate academic excellence and to thank all authors who contributed to the prestige, visibility and internationalization of our institution. However, it is worthwhile mentioning that there are many other monographs or edited volumes published by our colleagues in Romania or abroad, just as valuable as the ones included in this edited volume, which due to objective reasons were not included in this edition of the monograph, and which, with joined efforts, should be included in a future edition or in other similar monographs.

Vivat, crescat, floreat!

Daniel Dejica-Carțiș, Editor
Professor and Dean of the Faculty of Communication Sciences
Politehnica University Timișoara

CONTENTS

1. ENGINEERING SCIENCES

1.1. CIVIL ENGINEERING

1.1.1. CIVIL ENGINEERING AND INSTALLATIONS

1. **Numerical Analysis of Reinforced Concrete Structures (1993)**, Constantin Avram, Corneliu Bob, Richard Friedrich, Valeriu Stoian, Elsevier, Amsterdam, ISBN 0-444-98842-4;
2. **Seminar on Eurocode-2. Design of Concrete Structures (1994)**, Corneliu Bob, Ioannis Vayas (eds.), Klidarithmos, Athens, Greece;
3. **Behaviour of Steel Structures in Seismic Areas (1994)**, Federico Mazzolani, Victor Gioncu (eds.), CRC Press, E & FN Spon, an imprint of Chapman & Hall, 1995, ISBN: 978-0419198901;
4. **Computation of Building Services: Numerical and Optimisation Methods (1994)**, Ioan Sârbu, Editura Tehnică, ISBN 973-31-0525-2;
5. **Coupled Instabilities in Metal Structures (1996)**, Jacques Rondal, Dan Dubina, Victor Gioncu (eds.), Imperial College Press, ISBN 978-1860940330;
6. **Energy Optimisation of Water Distribution Systems (1997)**, Ioan Sârbu, Editura Academiei Române, ISBN 0-444-98842-4;
7. **Grundwasserhydraulik. Strömungs- und Transportvorgänge (1998)**, Ioan David, Springer/Vieweg, Teubner Verlag, Print ISBN 978-3-528-07713-6, Online ISBN 978-3-322-91593-1;
8. **Reinforced Concrete (1999)**, Ioan Cadar, Tudor Clipii, Agneta Tudor, Editura Orizonturi Universitare, ISBN 973-9400-38-8;
9. **Stability and Ductility of Steel Structures (1999)**, Dan Dubina, Miklos Ivanyi (eds.), Elsevier Science, ISBN: 9780080430164;
10. **Coupled Instabilities in Metal Structures (2000)**, Dinar Camotim, Dan Dubina, Jacques Rondal (eds.), Imperial College Press, London, ISBN: 1-86094-252-0;
11. **Construction of Roads (2000)**, Laurențiu Nicoară, Gheorghe Lucaci, Ion Costescu, Florin Belc, Editura Tehnică, ISBN: 973-31-1506-1;
12. **Ductility of Seismic Resistant Steel Structures (2002)**, Victor Gioncu, Federico Mazzolani, Spon Press an imprint of Taylor & Francis Group, ISBN: 0-419-22550-1;
13. **Mathematisch- numerische Modellierung technischer Systeme im Bauwesen (2005)**, Ioan David, Cuvillier Verlag, Göttingen, ISBN: 3-86537-590-1;
14. **Light Gauge Metal Structures Recent Advances (2005)**, Jacques Rondal, Dan Dubina (eds.), Springer Verlag, Berlin Wien, New York, ISBN 3-211-25258-4;
15. **Steel - A New and Traditional Material for Building (2006)**, Dan Dubina, Viorel Ungureanu (eds.), CRC Press, Taylor & Francis Group, Balkema, London, ISBN: 9780415408172;
16. **Sustainability of Constructions - Integrated Approach to Life-time Structural Engineering (2007)**, Luis Bragança, Viorel Ungureanu et al. (eds.), COST Publications of EU, ISBN 978-989-20-0787-8;
17. **Sustainability of Constructions - Integrated Approach to Life-time Structural Engineering (2008)**, Luis Bragança, Viorel Ungureanu et al. (eds.), COST Publications of EU, ISBN 978-3-86780-094-5;
18. **Sustainability of Constructions - Integrated Approach to Life-time Structural Engineering (2009)**, Luis Bragança, Viorel Ungureanu et al. (eds.), COST Publications of EU, ISBN 978-973-638-428-8;
19. **Designing Steel Structures for Fire Safety (2009)**, Jean-Marc Franssen, Venkatesh Kodur, Raul Zaharia, CRC Press Taylor & Francis Group, ISBN: 9780415548281;
20. **Sustainability in Science Engineering, Volume 1 (2009)**, Nicolae Robu, Corneliu Bob, Gheorghe Lucaci et al. (eds.), WSEAS Press, ISBN 1790-2769;

21. **Strengthening of the Frame Structure at the Timisoreana Brewery, Romania** – Book chapter published in **Case Studies of Rehabilitation, Repair, Retrofitting, and Strengthening of Structures (2010)**, Corneliu Bob, Sorin Dan, Catalin Badea, Aurelian Gruin, Liana Iures, IABSE-AIPC-IVBH, ETH Honggerberg, ISBN 978-3-85748-124-6;
 22. **Building Sustainability. Civil Engineer Approach (2010)**, Corneliu Bob, Tamas Dencsák, Lambert Academic Publishing, Saarbrücken, ISBN 978-3-8433-7441-5;
 23. **Sustainability of Constructions – Towards a better built environment (2011)**, Luis Bragança, Viorel Ungureanu et al. (eds.), COST Publications of EU, ISBN 978-999957-816-0-6;
 24. **Sustainability of Constructions - Integrated approach to life-time structural engineering. Volume 2 (2011)**, Luis Bragança, Viorel Ungureanu et al. (eds.), COST Publications of EU, ISBN 978-99957-816-2-0;
 25. **Thin-Walled Structures: Recent Research Advances and Trends (2011)**, Dan Dubina, Viorel Ungureanu (eds.), ECCS-European Convention for Constructional Steelwork, Ernst & Sohn, ISBN 978-92-9147-102-7;
 26. **Earthquake Engineering For Structural Design (2011)**, Victor Gioncu, Federico M. Mazzolani, Spon Press an imprint of Taylor & Francis, ISBN 0-444-98842-4;
 27. **Design of Cold-formed Steel Structures (2012)**, Dan Dubina, Raffaele Landolfo, Viorel Ungureanu, ECCS – European Convention for Constructional Steelwork, Ernst & Sohn, A Wiley Company, Berlin, ISBN 978-3-433-02979-4;
 28. **Energy Efficiency of Lightweight Steel-framed Buildings (2012)**, Paulo Santos, Luis Simoes da Silva, Viorel Ungureanu, ECCS – European Convention for Constructional Steelwork, ISBN 978-92-9147-105-8 ;
 29. **Connections in Steel Structures (2013)**, Dan Dubina, Daniel Grecea, ECCS – European Convention for Constructional Steelwork, ISBN 978-92-9147-114-0;
 30. **New Trends in Bridge Engineering and Efficient Solutions for Large and Medium Span Bridges (2013)**, Edward Petzek, Radu Bancila (eds.), Springer Viewweg, ISBN: 978-3-658-03713-0;
 31. **Seismic Design of Steel Structures (2014)**, Victor Gioncu, Federico Mazzolani, CRC Press, imprint of Taylor & Francis Group, ISBN-13: 978-0415242639, ISBN-10: 0415242630;
 32. **Economical Bridge Solutions Based on Innovative Composite Dowels and Integrated Abutments (2015)**, Edward Petzek, Radu Bancilă (eds.), Springer Viewweg, ISBN: 978-3-658-06416-7;
 33. **Sustainable building project in steel (SB_Steel) (2015)**, Heli Koukkari, Viorel Ungureanu, Adrian Ciutina et al., Publications Office of the European Union, Luxembourg, ISBN: 978-92-79-47497-2 ;
 34. **Ground-Source Heat Pumps: Fundamentals, Experiments and Applications (2015)**, Ioan Sarbu, Calin Sebarchievici, Elsevier, Amsterdam, ISBN: 978-0-12-804220-5;
 35. **Stability and Ductility of Steel Structures (2016)**, Dan Dubină, Viorel Ungureanu (eds.), ECCS-European Convention for Constructional Steelwork, Ernst & Sohn, ISBN 978-92-9147-133-1;
 36. **Design of Steel Structures for Buildings in Seismic Areas (2017)**, Raffaele Landolfo, Dan Dubina et al., ECCS – European Convention for Constructional Steelwork Ernst & Sohn, A Wiley Company, Berlin, ISBN: 9783433030103;
 37. **Solar Heating and Cooling Systems: Fundamentals, Experiments and Applications (2017)**, Ioan Sârbu, Călin Sebarchievici, Elsevier, Amsterdam, ISBN: 978-0-12-811662-3;
-
- 1.2. ELECTRICAL ENGINEERING, ELECTRONICS AND TELECOMMUNICATIONS
 - 1.2.1. ELECTRICAL ENGINEERING
 38. **Vector Control of AC Drives (1992)**, Ion Boldea and Syed Nasar, CRC Press, ISBN 978-0-8493-4408-4;
 39. **Electrothermy and Electrotechnology (volumes I and II) (1999)**, Ioan Şora, Nicolae Golovanov (coord.), Editura Tehnică, Bucureşti, ISBN 973-31-1144-9;

40. **The Induction Machine Handbook (2002)**, Ion Boldea, Syed Nasar, CCRC Press, ISBN 978-0-8493-0004-2;
41. **Electric Machines: Steady State, Transients, and Design with MATLAB® (2010)**, Ion Boldea, Lucian Tutelea, CRC Press, ISBN 978-1-4200-5572-6;
42. **Electric Machines and Drives (2011)**, Valentin Năvrădescu, Constantin Ghiță, Sorin Mușuroi, Academy of Sciences Publishing House, ISBN 978-606-8371-39-9;
43. **The Behavior in Stationary Regime of an Induction Motor Powered by Static Frequency Converters** – Book chapter published in **Induction Motors. Modelling and Control (2012)**, Sorin Mușuroi, InTech, ISBN 978-953-51-0843-6;
44. **Numerical Methods for Analyzing the Transients in Medium Voltage Networks** – Book chapter published in **Numerical Simulation From Theory to Industry (2012)**, Dumitru Toader, Stefan Haragus, Constantin Blaj, InTech, ISBN : 978-953-51-0749-1;
45. **Linear Electric Machines, Drives, and MAGLEVs Handbook (2013)**, Ion Boldea, CRC Press, ISBN 978-1-4398-4514-1;
46. **Synchronous Generators (2016)**, Ion Boldea, CRC Press, ISBN 978-1-4987-2356-5;
47. **Electric Drives (2017)**, Ion Boldea and Syed Nasar, CRC Press, ISBN 978-1-4987-4820-9;
48. **Reluctance Electric Machines: Design and Control (2019)**, Ion Boldea, Lucian Tutelea, CRC Press, ISBN: 978-1498782333;

1.2.2. ELECTRONICS

49. **Power Quality Data Compression** – book chapter published in **Power Quality Issues (2011)**, Gabriel Găspăresc, InTech, ISBN: 978-953-51-1068-2;
50. **Statistical Tools and Optoelectronic Measuring Instruments** – book chapter published in **Optoelectronic Devices and Properties (2011)**, Sabin Ionel, Ioana Ionel, InTech, ISBN: 978-953-307-204-3;
51. **Implementation of a CO Concentration Monitoring System using Virtual Instrumentation** – book chapter published in **Advanced Distributed Measuring Systems - Exhibits of Application (2012)**, Raul Ciprian Ionel, Aurel Gontean, Patricia Gherban-Draut, River Publishers, ISBN 9788792329721;
52. **Methods of power quality analysis** – book chapter published in **Power Quality Monitoring, Analysis and Enhancement (2015)**, Gabriel Găspăresc, InTech, ISBN: 978-953-307-330-9;

1.2.3. POWER ENGINEERING

53. **Matériaux Diélectriques et Matériel Electrique (1997)**, Bui Ai, Alexandru Vasilevici, Petru Andea, Dan Șurianu et al., Editura Tehnică, București, ISBN: 973-31-1159-7;
54. **Harmonic Impedance of Networks Within Electrical Power Systems (2000)**, Adrian Buta, Livius Milea, Adrian Pană, Editura Tehnică, ISBN: 973-31-1522-3;
55. **Command and Control of Electrical Networks Operation (2001)**, Vasile Dușa, Victor Vaida, Editura Tehnică, ISBN: 973-31-2048-0;
56. **Electric Power Systems (2006)**, Mircea Eremia (ed.), Editura Academiei Române, ISBN 973-27-1324-0;

1.3. SYSTEMS ENGINEERING, COMPUTERS AND INFORMATION TECHNOLOGY

1.3.1. COMPUTERS AND INFORMATION TECHNOLOGY

57. **Object-Oriented Metrics in Practice (2006)**, Michele Lanza, Radu Marinescu, Springer-Verlag, ISBN: 978-3-540-39538-6;
58. **Computer Arithmetic. Algorithms and Hardware Implementations (2012)**, Mircea Vlăduțiu, Springer, ISBN 978-3-642-18314-0, ISBN 978-3-642-18315-7 (eBook);

1.3.2. AUTOMATION AND APPLIED INFORMATICS

59. **On the Stability and Sensitivity Analysis of Fuzzy Control Systems for Servo-Systems** – book chapter published in **Fuzzy Systems Engineering, Theory and Practice (2005)**, Radu-Emil Precup, Stefan Preitl, Springer, Online ISBN: 978-3-540-32397-6, Print ISBN: 978-3-540-25322-8;
60. **Interpolative-Type Control Solutions** – book chapter published in **Soft Computing Based Modeling in Intelligent Systems (2009)**, Sanda Dale, Toma-Leonida Dragomir, Springer, ISBN: 978-3-642-00448-3;
61. **Automation (2009)**, Ioan Dumitrache (coord. ed.), Toma L. Dragomir (ed.), Editura Academiei Române, VOL. I: ISBN: 978-973-27-1883-4; 978-973-27-1882-7, VOL. II, ISBN: 978-973-27-1882-7; 978-973-27-2298-5;
62. **Optimal Control Systems with Reduced Parametric Sensitivity Based on Particle Swarm Optimization and Simulated Annealing** – book chapter published in **Intelligent Computational Optimization in Engineering Techniques and Applications (2011)**, Radu-Emil Precup et al., Springer, eBook ISBN: 978-3-642-21705-0; Hardcover ISBN: 978-3-642-21704-3, Softcover ISBN: 978-3-642-26940-0;
63. **Cutting Edge Research in New Technologies (2012)**, Constantin Voloşencu (ed.), IntechOpen Limited, London, U. K., ISBN 978-953-51-0463-6;
64. **New Technologies - Trends, Innovations and Research (2012)**, Constantin Voloşencu (ed.), IntechOpen Limited, London, U. K., ISBN 978-953-51-0480-3;
65. **Reference Value Generator of Maximum Power Point Coordinates of the Photovoltaic Panel External Characteristic** – book chapter published in **New Concepts and Applications in Soft Computing (2013)**, Toma-Leonida Dragomir, Flavius-Maxim Petcuț, Adrian Korodi, Springer, ISBN: 978-3-642-28959-0;
66. **System Reliability (2017)**, Constantin Voloşencu (ed.), IntechOpen Limited, London, U. K., ISBN 978-953-51-0463-6 978-953-51-3706-1, 978-953-51-3705-4;
67. **Actuators (2018)**, Constantin Voloşencu (ed.), IntechOpen Limited, London, U. K., ISBN: 978-1-78923-429-9, 978-1-78923-428-2;
68. **Fault Detection and Diagnosis (2018)**, Constantin Voloşencu (ed.), IntechOpen Limited, London, U. K., ISBN: 978-1-78984-437-5, 978-1-78984-436-8;
69. **Nature-Inspired Optimization Algorithms for Fuzzy Controlled Servo Systems (2019)**, Radu-Emil Precup, Radu-Codrut David, Butterworth-Heinemann, Elsevier, eBook ISBN: 978-0-128-16606-2, Paperback ISBN: 978-0-128-16358-0;

1.4. MECHANICAL ENGINEERING, MECHATRONICS, INDUSTRIAL ENGINEERING

1.4.1. MECHANICAL ENGINEERING

70. **Thermoenergetics and the Environment (1996)**, Ioana Ionel, Corneliu Ungureanu, Editura Tehnică, ISBN: 973-31-0746-8;
71. **Impact on Air Quality due to Romanian Power Plants (2001)**, Ioana Ionel, VDI Verlag GmbH, Düsseldorf, ISBN: 3-18-323315-0;
72. **Cellular and Porous Materials in Structures and Processes** – book chapter published in **Fracture Mechanics of Cellular Solids (2010)**, Liviu Marşavina, Springer, ISBN: 978-3-7091-0296-1;
73. **Nonlinear Dynamical Systems in Engineering. Some Approximate Approaches (2011)**, Vasile Marinca, Nicolae Herisanu, Springer, ISBN: 978-3-319-15373-5;
74. **The Optimal Homotopy Asymptotic Method. Engineering Applications (2015)**, Vasile Marinca, Nicolae Herisanu, Springer, ISBN: 978-3-319-15373-5;
75. **Fatigue of overhead power line conductors (2017)**, Anghel Cernescu, Ion Dumitru, Editura Academiei Române, ISBN 978-973-27-2783-6;

1.4.2. INDUSTRIAL ENGINEERING

76. **DMAIC Six Sigma for Improving Complex Processes** – book chapter published in **Understanding Six Sigma Concepts, Applications and Challenges (2018)**, Adrian Pugna, Sabina Potra, Romeo Negrea, Marian Mocan, Nova Science Publishers, Inc. New-York, ISBN: 978-1-53614-174-0;

1.4.3. MATERIALS ENGINEERING

77. **Amorphous and nanocrystalline alloys (2009)**, Cosmin Codrean, Viorel-Aurel Serban, Ion-Dragos Utu, VDM Verlag Dr. Müller, ISBN: 978-3-639-19845-4;

2. MATHEMATICS AND NATURAL SCIENCES

2.1. MATHEMATICS

78. **Handbook of Number Theory I (2006)**, Jozsef Sándor, Dragoslav S. Mitrinović and Borislav Crstici, **Handbook of Number Theory II (2006)**, Jozsef Sándor, Borislav Crstici, Kluwer Academic Publishers, Dordrecht/ Boston/London, ISBN 1-4020-2546-7 (HB), ISBN 1-4020-2547-5 (e-book);
79. **Generalized Ulam–Hyers Stability Results: A Fixed Point Approach** – book chapter published in **Handbook of Functional Equations – Stability Theory (2014)**, Liviu Cădariu, Springer, ISBN 978-1-4939-1286-5;

2.2. CHEMISTRY

80. **Biochemistry. Vol. I: Fundamentals (2007)**, Alfa-Xenia Lupea, Editura Academiei Române, ISBN 978-973-27-1368-6, **Biochemistry. Vol. II: Photosynthesis, Hormonal Control, Genetic Information (2007)**, Aurel Ardelean, Alfa-Xenia Lupea, Editura Academiei Române, ISBN 978-973-27-1369-3;
81. **Use of phosphorous-containing polymers for the removal of metal ions from waste waters** – book chapter published in **Phosphorous-Based Polymers: From Synthesis to Applications (2014)**, Lavinia Lupa, Adriana Popa, Gheorghe Ilia, Royal Society of Chemistry, ISBN 978-1-84973-646-6;
82. **A basic overview of fuel cells: Thermodynamics and cell efficiency** – book chapter published in **Organic-Inorganic Composite Polymer Electrolyte Membranes: Preparation, Properties, and Fuel Cell Applications (2017)**, Narcis Duțeanu et al., Springer, ISBN 978-3-319-52739-0;
83. **Use of ionic liquids in solid-liquid separation processes** – book chapter in **Progress and Developments in Ionic Liquids (2017)**, Lavinia Lupa, Petru Negrea, Adriana Popa, InTech, ISBN 978-953-51-2901-1;
84. **Recent Progress Towards Scaling Up of MFCs** – book chapter published in **Microbial Fuel Cell: A Bioelectrochemical System that Converts Waste to Watts (2018)**, Dipak Jadhav, Narcis Duțeanu et al., Springer, ISBN 978-3-319-66793-5;

3. SOCIAL SCIENCES

3.1. ADMINISTRATIVE SCIENCES

3.1.1. PUBLIC ADMINISTRATION

85. **Assessing Romanian financial sector stability: the importance of the international economic climate** – book chapter published in **Globalization, Integration and Transition: Challenges for Developing and Developed Countries (2010)**, Claudiu Albuiescu, Lambert Academic, ISBN-13: 978-3838311654, ISBN: 978-3-8383-1165-4;
86. **Forecasting the Growth Rate, the Exchange Rate and the Inflation Rate in Romania: A Comparison of Different Forecasting Models** – book chapter published in **Selected Issues in Macroeconomic and Regional Modeling: Romania as an Emerging Country in the EU (2016)**, Claudiu Albuiescu, Aviral Tiwari, Nova Science Publishers, ISBN-13: 978-1634849364, ISBN: 978-1-63484-966-1;

3.2. ECONOMICS

3.2.1. MANAGEMENT

87. **Competitiveness Strategies And Tactics For The International Scientific-Academic Associations And Clusters** – book chapter published in **DAAAM International Scientific Book (2008)**, Horia Popa, Marian Mocan, Monica Izvercianu, Liana Pater, DAAAM International, Vienna, Austria, ISBN 978-3-901509-66-7;
88. **Clustering and Clusters. A Systemic Approach** – book chapter published in **DAAAM International Scientific Book (2010)**, Horia Popa, Marian Mocan, Monica Izvercianu, Liana Pater, DAAAM International, Vienna, Austria, ISBN 978-3-901509-74-2;
89. **The role of the educational system to the entrepreneurial dynamics an international comparative perspective** – book chapter published in **Post-doctoral studies in economy (2013)**, Matei Tămășilă, Editura Academiei Române, ISBN-978-973-27-2290-9;

4. HUMANITIES AND ARTS

4.1. PHILOLOGY

4.1.2. APPLIED MODERN LANGUAGES

90. **Écrire pour son lecteur-la pratique de l'expression écrite (2010)**, Marion-Ivonne Cohen-Vida, Éditions universitaires européennes, ISBN 978 613-1-55602-9;
91. **Investing in... Science and Research (2013)**, Daniel Dejica, Sebastian Chirimbu (eds.), ECKO Academic Publishing, USA, ISBN 978-1-4276-5408-3;
92. **Interkultureller-DaF-Unterricht in Rumänien (2015)**, Andreea Rodica Ruthner, Verlag DR. Kovač, ISBN 978-3-8300-8425-9;
93. **The Discourse of Tourism and National Heritage: A Contrastive Study from a Cultural Perspective (2015)**, Claudia Elena Stoian, Cambridge Scholars Publishing, ISBN 978-1-4438-8219-4;
94. **Language and Communication in the Digital Era. Challenges and Perspectives (2016)**, Daniel Dejica, Gyde Hansen, Peter Sandrini, Iulia Para (eds.), Warsaw/Berlin: DeGruyter Open, ISBN: 978-3-11-047204-2, e-ISBN: 978-3-11-047205-9;
95. **Body Conundrums And Pleasuring Startegies In The Postmodern Novel (2016)**, Andrea Kriston, Jate Press Szeged, ISBN 978-963-315-289-8;
96. **Fostering Transcultural Communication: The Role of Culture-bound Words in the Translation of Online Tourist Texts** – book chapter published in **Transcultural Communication in Multilingual Dialogue (2018)**, Daniel Dejica, Claudia Stoian, VERLAG DR. KOVAC, ISBN-10: 3830098375, ISBN-13: 978-3830098379;
97. **An English-Romanian and Romanian-English Cultural Thematic Dictionary (2018)**, Claudia Stoian, Simona Șimon, Cambridge Scholars Publishing, ISBN 978-1-5275-1136-1;
98. **A Multilingual Dictionary of Education: English-German-French-Romanian (2018)**, Simona Șimon, Claudia Stoian, Anca Dejica-Carțiș, Andrea Kriston, JATEPress, ISBN 978 963 315 375 8;
99. **The Language of the Arts and Literature: An English-Romanian and Romanian-English Dictionary (2018)**, Simona Șimon, Claudia E. Stoian, Cambridge Scholars Publishing, ISBN (10): 1-5275-1368-8, ISBN (13): 978-1-5275-1368-6;

4.2. ARCHITECTURE

100. **Sustainable Urban Development Through the Empowering of Local Communities** – book chapter published in **Sustainable Development - Policy and Urban Development - Tourism, Life Science, Management and Environment (2012)**, Radu Radoslav et al., InTech, ISBN : 978-953-51-0100-0.

Books in highlight

MAGICAL CUBE

Cristian DUMITRESCU, Cristina-Maria POVIAN

Jate Press Kiadó, Szeged, 2019, Pages: 326

ISBN: 978-963-315-406-9

Short description of the context

This book describes a didactic method that has been perfected during many years of teaching.

The cube, this paper's protagonist, initiates the reader into the secrets of technical drawing representations and helps acquire the necessary skills to imagine and illustrate in plane representation various spatial objects.

Purpose and Motivation of the book

The aim of this book is to help those who have the required tenacity and motivation to acquire the necessary plane representation skills to illustrate space in different poses.

Summary

The plane images of different spatial elements are represented in view, axonometry and perspective that are illustrated in relationship with a wireframe cube. With these images, we will perform a series of visual, positioning and processing operations that are grouped into 12 chapters according to a specific topic.

After we will look at the basics of axonometric and view representations of space shapes (chapter 1), we will view them from different spatial areas (chapter 2), they will be positioned (chapter 3) and illustrated in space using particular components (chapter 4), inscribed into each other or tangent (chapter 5), unfolded on a plane (6) or geometrically transformed (7) sectioned (8), rotated (9) or intersected with different solids or voids (10).

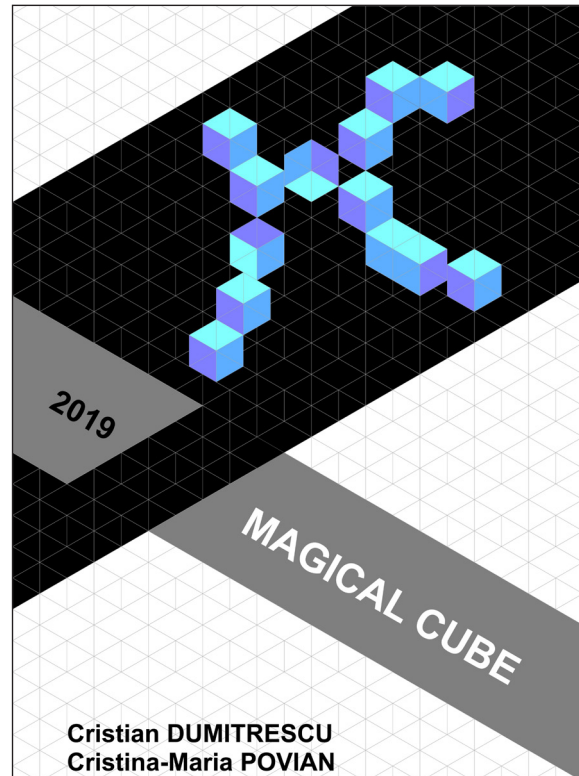

Chapter 11 presents these volumes in a conic projection through perspective images and the last chapter compares all these plane representations of spatial elements: view, axonometry and free perspective.

The paper concludes with a series of graphic constructions, grouped in different categories which will be used whenever needed.

Books List

1. Alexa, V. *Ingenieria și managementul cercetării și inovării*, Editura Politehnica, Timișoara, 2019, ISBN 978-606-35-0312-2;
2. Alexa, V. *Mecanica fluidelor în experimente*, Editura Politehnica, Timișoara, 2019, ISBN 978-606-35-0309-2;
3. Alexa, V. *Procesul laminării longitudinale simetrice și asimetrice*, Editura Politehnica, Timișoara, 2019, ISBN 978-606-35-0306-1;
4. Băloj, F.I., Borlea, I. *MATLAB în energetică. Aplicații practice*, Editura Politehnica, Timișoara, 2019, ISBN 978-606-35-0314-6;
5. Belega, D., Gășpăresc, G. *Măsurări electrice și electronice. Aplicații practice*, Editura Politehnica, Timișoara, 2019, ISBN 978-606-35-0297-2;
6. Bîtea, C. *Managementul organizațiilor din turismul de wellness din România. Implicațiile asupra performanței acestora*, Editura Politehnica, Timișoara, 2019, ISBN 978-606-35-0308-5;
7. Bota, C., Lăpădat, M., Pașca, M., Popescu, D. *Algebră liniară și geometrie analitică. Culegere de probleme*, Editura Politehnica, Timișoara, 2019, ISBN 978-606-35-0329-0;
8. Botescu, M. *Ambient arhitectural. Universitatea Politehnica Timișoara – 100 de ani de tradiție și modernitate/Arhitectural environment. Politehnica University Timișoara – 100 years of tradition and modernity*, Editura Politehnica, Timișoara, 2019, ISBN 978-606-35-0322-1;
9. Buncianu, D. *Manual de proceduri și instrucțiuni de inventariere a patrimoniului*, Editura Politehnica, Timișoara, 2019, ISBN 978-606-35-0343-6;
10. Cădariu, L., Lupa, N., Manolescu, L. *Analiza matematică. Șiruri și serii*, Editura Politehnica, Timișoara, 2019, ISBN 978-606-35-0270-5;
11. Constantin, A.T., Nicoară, Ș.V. *Rezistența materialelor în ingineria instalațiilor*, Editura Politehnica, Timișoara, 2019, ISBN 978-606-35-0289-7;
12. Cornea, O., Hulea, D., Muntean, N. *Convertoare de curent continuu hibride*, Editura Politehnica, Timișoara, 2019, ISBN 978-606-35-0333-7;
13. Cristea, M., Lovasz, A.E., Oteșteanu, E. *Școala Politehnică din Timișoara. Vectorii școlii în 100 de cursuri/Foreruners in 100 lecture notes*, Editura Politehnica, Timișoara, 2019, ISBN 978-606-35-0325-2;
14. De Sabata, C. *The Painter's Secret Garden*, Editura Politehnica, Timișoara, 2019, ISBN 978-606-35-0255-2;
15. Dejica-Carțș, D. (ed.) *Politehnica University Timișoara, 1989-2019: 100 scientific books in highlight*, Editura Politehnica, Timișoara, 2019, ISBN 978-606-35-0319-1;
16. Dumitrescu, C., Anghel, A.A. *Reprezentări plane ale formelor spațiale. Culegere de aplicații de desen tehnic și reprezentări geometrice*, Editura Politehnica, Timișoara, 2019, ISBN 978-606-35-0275-0;
17. Dumitrescu, C., Povian, C.M. *Magical Cube*, Jate Press Kiadó, Szeged, 2019, ISBN: 978-963-315-406-9;
18. Erdodi, G.M., Muncut, E., Babescu, M. *Autovehicule electrice și hibride. Ediție revizuită și adăugită*, Editura Politehnica, Timișoara, 2019, ISBN 978-606-35-0330-6;
19. Gherheș, V. *Comunicare tactilă pentru deficienții de vedere*, Editura Eikon, București, 2019, ISBN 978-606-711-964-0;
20. Greconici, M. *Electric Circuits. DC and Ac Steady State*, Editura Politehnica, Timișoara, 2019, ISBN 978-606-35-0331-3;

21. Hamaoui, N. Mediation linguistique enjeux culturels et mediatiques à l'ère du numérique, Editura Politehnica, Timișoara, 2019, ISBN 978-606-35-0317-7;
22. Herman, M. Elemente de analiză economică a transporturilor, Editura Politehnica, Timișoara, 2019, ISBN 978-606-35-0273-6;
23. Ilie, M., Vodă, M., Walkovszky, L. (CD) Grafică inginerescă. Noțiuni de bază și aplicații. Volumul I, Editura Politehnica, Timișoara, 2019, ISBN 978-606-35-0341-2/ISBN 978-606-35-0342-9 Vol. I;
24. Iosif, A., Sârbu, I. Modelare cu elemente de frontieră. teorie și aplicații în ingineria instalațiilor, Editura Politehnica, Timișoara, 2019, ISBN 978-606-35-0327-6;
25. Lelea, D., Cioablă, A.E. (CD) Metode numerice în ingineria mecanică, Editura Politehnica, Timișoara, 2019, ISBN 978-606-35-0350-4.
26. Linul, E., Galațanu, S.V., Silaghi-Perju, D. (CD) Fundamente de inginerie mecanică. Solicitări mecanice, Editura Politehnica, Timișoara, 2019, ISBN 978-606-35-0279-8;
27. Linul, E., Marșavina, L., Văleanu, C. (CD) Comportamentul la rupere al spumelor poliuretanică, Editura Politehnica, Timișoara, 2019, ISBN 978-606-35-0281-1;
28. Linul, E., Șerban, D.A., Pîrvulescu, L.D., Galațanu, S.V., Hlușcu, M., Sava, M., Sisak, I. (CD) Rezistența materialelor. Lucrări de laborator, Editura Politehnica, Timișoara, 2019, ISBN 978-606-35-0280-4;
29. Manea, A.S., Stroiti, D.C. Hidraulică și mașini hidraulice. Aplicații, Editura Politehnica, Timișoara, 2019, ISBN 978-606-35-0294-1;
30. Mihărtescu, A.A. Marketing imobiliar, Editura Politehnica, Timișoara, 2019, ISBN 978-606-35-0339-9;
31. Mihărtescu, A.A. Marketing industrial, Editura Politehnica, Timișoara, 2019, ISBN 978-606-35-0338-2;
32. Negruț, M.L. Management concept in the Romanian Construction Industry, Editura Politehnica, Timișoara, 2019, ISBN 978-606-35-0340-5;
33. Oană, T.L., Negruț, M.L. Managementul proiectelor de construcții, Editura Politehnica, Timișoara, 2019, ISBN 978-606-35-0337-5;
34. Ordodi, L.V., Todea A. Metode uzuale de analiză a produselor alimentare. Lucrări practice, Editura Politehnica, Timișoara, 2019, ISBN 978-606-35-266-8;
35. Ostoia, D. Diagnosticarea autovehiculelor, Editura Politehnica, Timișoara, 2019, ISBN 978-606-35-0344-3;
36. Ostoia, D. Sisteme de alimentare cu combustibil pentru autovehicule rutiere, Editura Politehnica, Timișoara, 2019, ISBN 978-606-35-0345-0;
37. Păunescu, D., Negrea, R., Cădariu, L., Țigan, G., Jivulescu, M., Bînzar, T., Arieșanu, C., Lăzureanu, C., Gîrban, A., Bundău, O., Juratoni, A., Hedrea, C., Petrișor, C., Ekstein, A., Lupa, N. Culegere de probleme de matematică pentru examenul de admitere din anul 2020 la Universitatea Politehnica Timișoara, Editura Politehnica, Timișoara, 2019, ISBN 978-606-35-0315-3;
38. Pop-Călimanu, I.M., Filip, A., Mîrșu, R., Căleanu, C. Circuite Electronice fundamentale. Teorie și probleme, Editura Politehnica, Timișoara, 2019, ISBN 978-606-35-0332-0;
39. Rădac, M.B. Tehnici de învățare automată cu aplicații, Editura Politehnica, Timișoara, 2019, ISBN 978-606-35-0292-7;

40. Șerban, D.A. Introducere în mecanica solidului deformabil, Editura Politehnica, Timișoara, 2019, ISBN 978-606-35-0271-2;
41. Șerban, D.A., Negru, R. (CD) Analiza structurilor mecanice cu Abasqus/CAE, Editura Politehnica, Timișoara, 2019, ISBN 978-606-35-0127-2;
42. Șerban, D.A., Negru, R. (CD) Rezistența materialelor. Solicitări simple. Vol. I, Editura Politehnica, Timișoara, 2019, ISBN 978-606-35-0276-7/ ISBN 978-606-35-0277-4 (vol. I);
43. Șerban, V.A., Oteșteanu, M., Ronkov, L., Sîrbu, R.M. (eds.) Politehnica™ 100% Performanță: Povești și visuri împlinite, Editura Politehnica, Timișoara, 2019, ISBN 978-606-35-0323-8;
44. Șerban, V.A., Răduță, A., Codrean, C., Uțu, I.D., Opreș, C. Materiale și tehnologii primare în experimente. Ediție revizuită și adăugită, Editura Politehnica, Timișoara, 2019, ISBN 978-606-35-0318-4;
45. Smicală, I. Contribuții la teoria numerelor. Ediție revizuită și adăugită, Editura Politehnica, Timișoara, 2019, ISBN 978-606-35-0320-7;
46. Ștefănescu, O.E., Ștefănescu, M. Chimie analitică instrumentală. Principii. Aplicații. Exerimente. Volumul II, Editura Politehnica, Timișoara, 2019, ISBN 978-606-35-0004-6/ISBN 978-606-35-0006-0 vol. II;
47. Stoica, V. Echipamente electrice, electronice și de control pentru autovehicule rutiere. Experimente de monitorizare și control, Editura Politehnica, Timișoara, 2019, ISBN 978-606-35-0268-2;
48. Stoica, V. Mașini termice cu piston. Elemente de calcul, Editura Politehnica, Timișoara, 2019, ISBN 978-606-35-0274-3;
49. Totorean, A. Hemodinamică. Note de curs, Editura Politehnica, Timișoara, 2019, ISBN 978-606-35-0283-5;
50. Totorean, A.F., Bernad, Ș.I., Totorean, C.I. (CD) Metode numerice aplicate în onvestigarea sistemului cardiovascular. Hemodinamica bypass-ului aortocoronarian, Editura Politehnica, Timișoara, 2019, ISBN 978-606-35-0282-8;
51. Totorean, A.F., Bernad, Ș.I., Totorean, C.I. Metode numerice aplicate în onvestigarea sistemului cardiovascular. Hemodinamica bypass-ului aortocoronarian, Editura Politehnica, Timișoara, 2019, ISBN 978-606-35-0282-8;
52. Tulcan, A. (Coordonator) Tehnologii de deformare plastică. Aplicații, Editura Politehnica, Timișoara, 2019, ISBN 978-606-35-0305-4;
53. Universitatea Politehnica Timișoara Dies Academicus 2015-Ib. engleză, Editura Politehnica, Timișoara, 2019, ISBN 978-606-35-0265-1;
54. Universitatea Politehnica Timișoara Dies Academicus 2015-Ib. română, Editura Politehnica, Timișoara, 2019, ISBN 978-606-35-0254-5;
55. Vulpoi, E.L. La traduccion audiovisual z el perfil der traductor audiovisual en Rumania, Editura Politehnica, Timișoara, 2019, ISBN 978-606-35-0316-0.

Book Chapters List

1. Blaabjerg, F., Ma, K. RENEWABLE ENERGY SYSTEMS WITH WIND POWER, POWER ELECTRONICS IN RENEWABLE ENERGY SYSTEMS AND SMART GRID: TECHNOLOGY AND APPLICATIONS, Book Series: IEEE Press Series on Power Engineering, Pages: 315-345, Wiley-IEEE Press, Piscataway, NJ, UNITED STATES, 2019, ISBN: 978-1-119-51566-1; 978-1-11-951562-3, Book DOI: 10.1002/9781119515661;
2. Dubină, D., Dinu, F., Văcăreanu, R.S. Istoria construcțiilor, Vol. 1: Mecanica, tehnicile de prelucrare și construcțiile, ISTORIA TEHNICII ȘI A INDUSTRIEI ROMÂNEȘTI, Seria: CIVILIZAȚIA ROMÂNEASCĂ, 24, Pag. 389-552, EDITURA ACADEMIEI ROMÂNE, București, 2019, ISBN 978-973-27-3054-6, ISBN 978-973-27-2992-2;
3. Nafoarniță, I. Învățământ și Cercetare în domeniul radar în Universitatea POLITEHNICA Timișoara, RADARUL ROMÂNESC. O ISTORIE VIE, Seria: Repere istorice, Pag. 345, Editura AGIR, București, 2019, ISBN 978-973-720-769-2;
4. Nafoarniță, I. Anexa 2 Lucrări didactice și de cercetare în domeniul radioelectronica de radiolocație, RADARUL ROMÂNESC. O ISTORIE VIE, Seria: Repere istorice, Pag. 509-532, Editura AGIR, București, 2019, ISBN 978-973-720-769-2;
5. Popescu, I., Banabic, D., de Sabata, C., Voicu, M. Istoria învățământului tehnic din România, Vol. 2: Electrotehnica, energetica, transporturile și învățământul tehnic, ISTORIA TEHNICII ȘI A INDUSTRIEI ROMÂNEȘTI, Seria: CIVILIZAȚIA ROMÂNEASCĂ, 25, Pag. 356-461, EDITURA ACADEMIEI ROMÂNE, București, 2019, ISBN 978-973-27-3055-3, ISBN 978-973-27-2992-2;
6. Tănăsescu, F., Boldea, I. Istoria electrotehnicii, Vol. 2: Electrotehnica, energetica, transporturile și învățământul tehnic, ISTORIA TEHNICII ȘI A INDUSTRIEI ROMÂNEȘTI, Seria: CIVILIZAȚIA ROMÂNEASCĂ, 25, Pag. 1-89, EDITURA ACADEMIEI ROMÂNE, București, 2019, ISBN 978-973-27-3055-3, ISBN 978-973-27-2992-2.

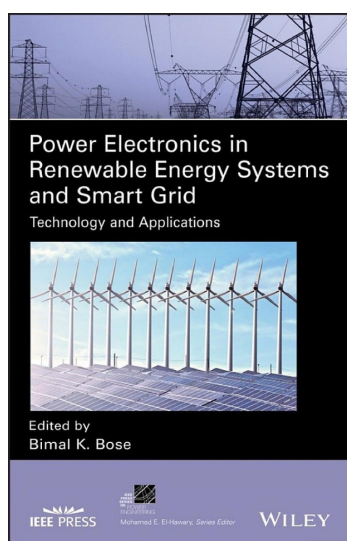

Indexed in Web of Science -
Clarivate Analytics



Politehnica University Timisoara



Piata Victoriei No. 2
RO 300006, Timisoara
Fax: +40 256 40 30 21
Email: rector@upt.ro
www.upt.ro



Editura **POLITEHNICA**

ISSN 1841-2769
ISSN-L 1841-2769